

MOBOTIX NAS 4盤位/16路

快速安裝手冊



Mx-S-NAS4A-16
(產品類別: 451-G)

20.100.306-01_ZH-TW_07/2019

安全須知和注意事項

1. 該型號NAS 的工作溫度適應于0 – 40°C/32 – 104°F 之間,相對濕度0 – 95 %。請確保使用環境通風性能良好。
2. 請正確提供與該款NAS 連接的電源線路,供電設備和電壓(90 W, 100 – 240VAC, 50/60 Hz)。
3. 請勿將設備置於陽光直射下,勿靠近有化學物質的場所。請確保使用環境的適宜溫度和濕度。
4. 清潔前,請務必拔去電源插頭,中斷設備的電源連接。清潔主體時請用幹潔的毛巾。切勿使用化學物質或者噴霧劑清潔設備。
5. 設備運行時,禁止在設備上放置任何其他物體,避免設備運載過熱,散溫受阻。
6. 安裝硬碟時,請使用平頭螺絲釘(設備內包裝提供),用於硬碟的固定。
7. 請勿將設備靠近任何液體。
8. 禁止將該設備安放在任何不穩定的平臺表面,避免設備摔落造成損壞。
9. 確保使用區域提供的電壓符合設備要求。如無法確認,請聯繫當地的代理商和供電單位。
10. 禁止在電源線上放置任何物體。
11. 請勿自行嘗試維修該NAS 設備。不正確的操作會引發觸電或其他危險情況。如有任何需求,請聯繫當地代理商。
12. 機架式NAS設備底盤(或稱為安裝支架) 只允許安裝在伺服器機房,並由經過授權的認證IT 工程師或者管理人員操作維護。伺服器機房只有認證人員持鑰匙或者門禁系統進入。

警告:

- 錯誤的電池安裝會引發爆炸的危險。電池更換需使用製造商認可的相同或者同類型號。請按照製造商的指示,棄放廢舊電池。
- 禁止觸摸設備內的風扇,避免造成嚴重傷害。

1

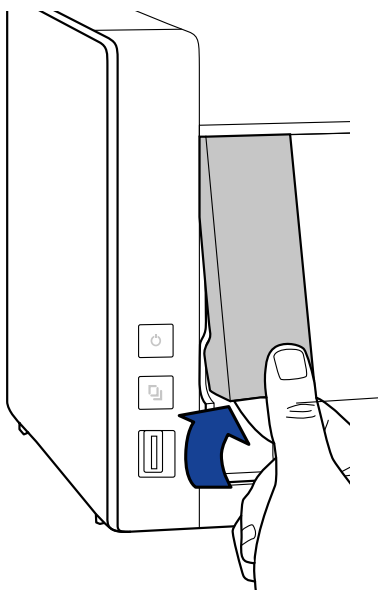

2

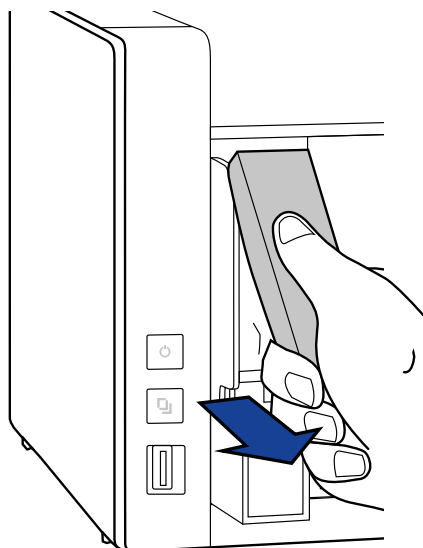

3

2.5" / SSD

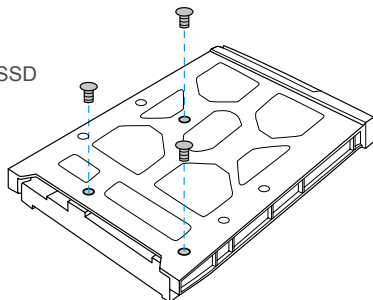

3.5" HDD

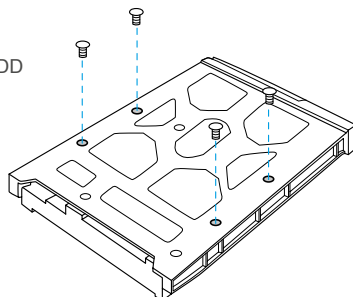

4

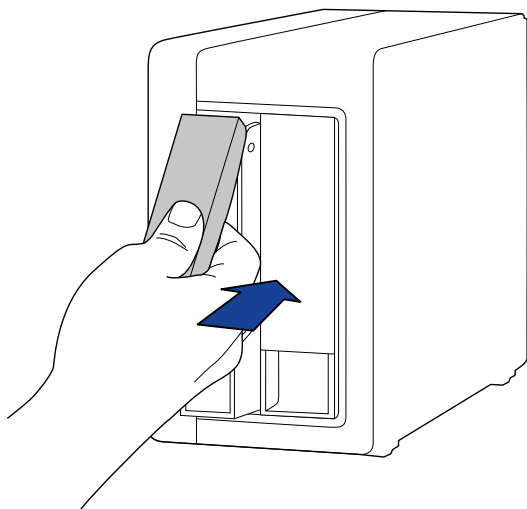

初始化設定會刪除硬碟上的所有資料!!

HDD/SSD

www.mobotix.com > Support > Download Center > Documentation > Brochures & Guides > White Lists

5

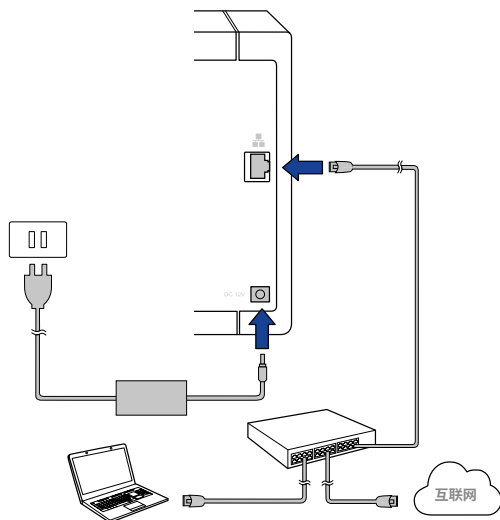

6

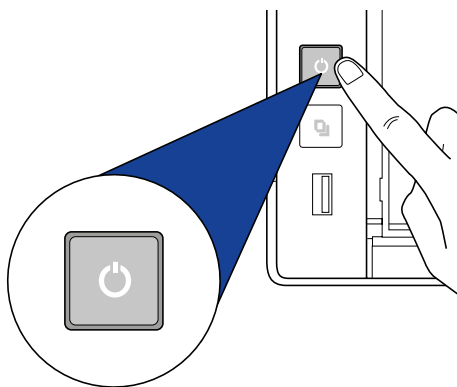

 **注意：** 我們提供的電源連接線僅用於MOBOTIX NAS設備！

軟體安裝下載位址



www.mobotix.com/software-downloads > MxNAS > MOBOTIX NAS Device Finder



www.mobotix.com/manuals

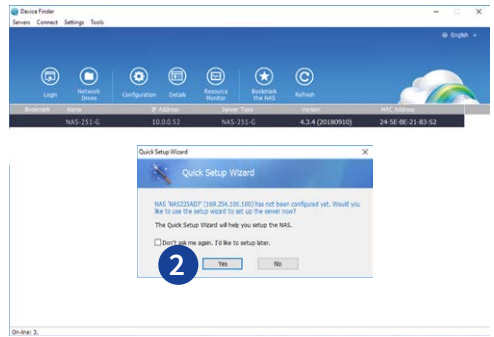
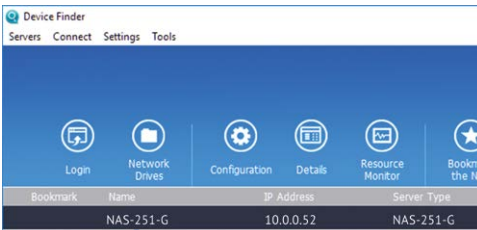

 **注意:** 授权许可不受 Windows 防火墙的限制

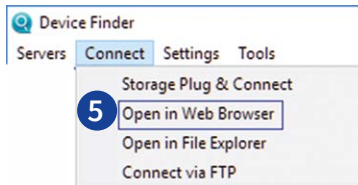
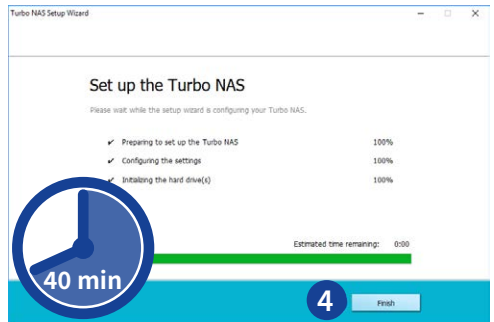
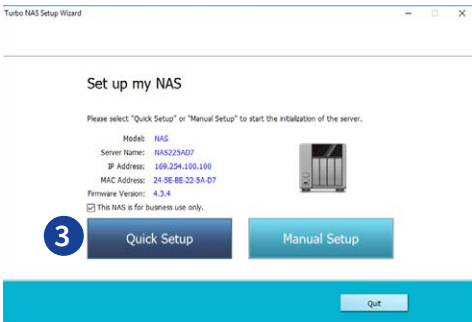

存儲軟體的安裝

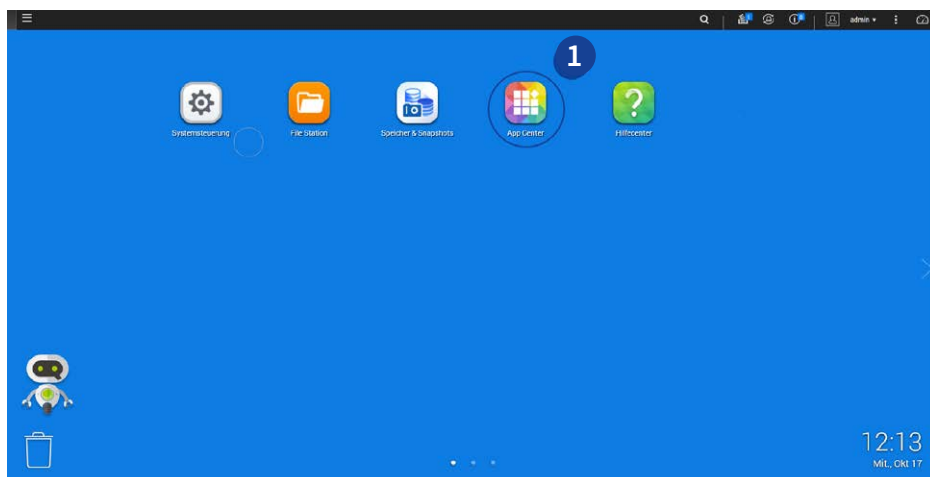

首先安裝Container Station App software，再安裝QVR Pro software。

 **注意：** 軟體不支援自動更新！

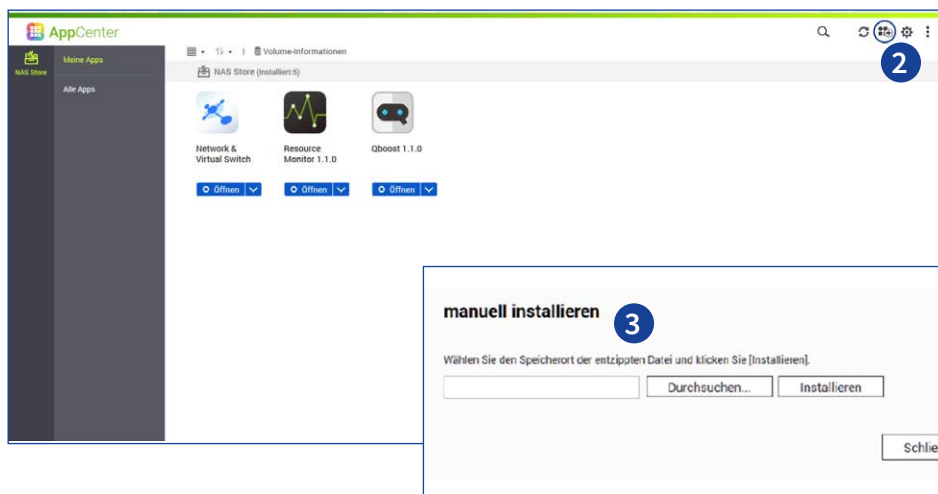

MOBOTIX NAS 軟體下載位址

www.mobotix.com/software-downloads > MxNAS > MOBOTIX NAS Container Station/QVR Pro Software

操作指導下載位址

www.mobotix.com/manuals > Accessories > MOBOTIX NAS

視頻教程下載位址

www.mobotix.com/video-tutorials

BSMI Notice



警告使用者：這是甲類的資訊產品，在居住的環境中使用時，可能會造成射頻干擾，在這種情況下，使用者會被要求採取某些適當的對策。

CE Notice



This device complies with the applicable rules and regulations of the European Union.

FCC Notice



This device complies with part 15 of the FCC Rules. Operation is subject to the following two conditions: (1) This device may not cause harmful interference, and (2) this device must accept any interference received, including interference that may cause undesired operation.



MOBOTIX

BeyondHumanVision

Manufacturer

MOBOTIX AG
Kaiserstrasse
67722 Langmeil
Germany

Phone: +49 6302 9816-103

Fax: +49 6302 9816-190

www.mobotix.com

sales@mobotix.com

Registration Office: Kaiserslautern Local Court

Registration Number: HRB 3724

Tax Office: Worms-Kirchheimbolanden, Germany

Tax Code: 44/676/0700/4

VAT ID: DE202203501

You can find the latest version of this and other documents (e.g., declarations of conformity) at www.mobotix.com in the **Support > Download Center > Documentation > Manuals** section.



Technical specifications subject to change without notice!

