

Quick Installation

MOBOTIX M73

© 2020 MOBOTIX AG

V06_5/18/2020



TOC

Support	5
Imprint	7
Safety Warnings	9
Legal Notes	11
Notes on System Security	13
Cleaning the Camera and Lenses	15
Drilling Template	17
mx_DT_M73_de-en-fr	18
Delivered Parts and Dimensions	19
MOBOTIX M73: Scope of Delivery	20
M73 – Dimensions	23
Technical Specifications	25
Mounting	33
Before Mounting the Camera	35
Installation of the Sensor Modules	36
Opening the Module Housing	41
Installing the Security Clips	44
Closing the Module Housing	46
Replacing the default front plate with a thermal front plate	48
Opening the Module Housing	49
Removing the Security Clips	51
Removing the Sensor Modules	51
Installing the Sensor Modules	54
Closing the Module Housing	58
Mounting Options	61
Mounting to a Wall	61
Connecting the Camera	65

Finishing the Installation of the Camera	68
Operating the Camera	73
Getting Started	73
Boot Options of the Camera	74
Network Settings	77
Adjust the Camera	85
Focusing the TELE 15° Sensor Module	86
Camera Software in the Browser	91
Basic Settings	92
Configuring Sensor Modules	93

Support

If you need technical support, please contact your MOBOTIX dealer. If your dealer cannot help you, he will contact the support channel to get an answer for you as quickly as possible.

If you have Internet access, you can open the MOBOTIX help desk to find additional information and software updates. Please visit:

www.mobotix.com > **Support** > **Help Desk**



Imprint

This document is part of the camera manufactured by MOBOTIX AG (called manufacturer in the following); the document describes how to use and to configure the camera and its components.

Subject to change without notice.

Copyright Information

This document is protected by copyright. Passing on information to others is not permitted without the prior written consent of the manufacturer. Violations will be subject to criminal punishment.

Patent and Copy Protection

All rights reserved. Trademarks or registered trademarks belong to the corresponding owners.

Address

MOBOTIX AG
Kaiserstrasse
67722 Langmeil
Phone: +49 6302 9816-103
E-Mail: sales@mobotix.com
Internet: www.mobotix.com

Support

See [Support](#), S. 5.

Safety Warnings

- This product must not be used in locations exposed to the dangers of explosion.
- Make sure that you install this product as outlined in this document. A faulty installation can damage the camera!
- When installing this product, make sure that you are only using genuine MOBOTIX parts and MOBOTIX connection cables. Only install this product on suitable, solid materials that provide for a sturdy installation of the fixing elements used.

Electrical installation: Electrical systems and equipment may only be installed, modified and maintained by a qualified electrician or under the direction and supervision of a qualified electrician in accordance with the applicable electrical guidelines. Make sure to properly set up all electrical connections.

Electrical surges: MOBOTIX cameras are protected against the effects of small electrical surges by numerous measures. These measures, however, cannot prevent the camera from being damaged when stronger electrical surges occur. Special care should be taken when installing the camera outside of buildings to ensure proper protection against lightning, since this also protects the building and the whole network infrastructure.

Hot surfaces: The M73 must not be installed within the reach of persons. Due to the high power of the processor and depending on the operating environment, the camera housing can reach **high temperatures**. This does not harm the camera in any way.

Power off before opening the camera: Make sure the power supply to the camera is disconnected before opening the camera housing (e.g., when exchanging the SD card or connecting wires inside the housing).

Network security: MOBOTIX products include all of the necessary configuration options for operation in Ethernet networks in compliance with data protection laws. The operator is responsible for the data protection concept across the entire system. The basic settings required to prevent misuse can be configured in the software and are password-protected. This prevents unauthorized parties from accessing these settings.

Legal Notes

Special Export Regulations!

Cameras with thermal image sensors ("thermal cameras") are subject to the special export regulations of the U.S.A. and including the ITAR (International Traffic in Arms Regulation):

- According to the currently applicable export regulations of the U.S.A. and the ITAR, cameras with thermal image sensors or parts thereof must not be exported to countries embargoed by the U.S.A., except if a special permit can be presented. At present, this applies to the following countries: Syria, Iran, Cuba, North Korea, Sudan and Krim. The same export ban applies to all persons and institutions listed in "The Denied Persons List" (see www.bis.doc.gov, "Policy Guidance > Lists of Parties of Concern"; <https://www.treasury.gov/resource-center/sanctions/sdn-list/pages/default.aspx>).
- Under no circumstances must the camera itself or its thermal image sensors be used in the design, the development or in the production of nuclear, biological or chemical weapons or in the weapons themselves.

Legal aspects of video and sound recording:

You must comply with all data protection regulations for video and sound monitoring when using MOBOTIX AG products. Depending on national laws and the installation location of the M73, the recording of video and sound data may be subject to special documentation or it may be prohibited. All users of MOBOTIX products are therefore required to familiarize themselves with all applicable regulations and to comply with these laws. MOBOTIX AG is not liable for any illegal use of its products.

Declaration of Conformity

The products of MOBOTIX AG are certified according to the applicable regulations of the EC and other countries. You can find the declarations of conformity for the products of MOBOTIX AG on www.mobotix.com under Support > Download Center > Certificates & Declarations of Conformity.

RoHS Declaration

The products of MOBOTIX AG are in full compliance with European Unions Restrictions of the Use of Certain Hazardous Substances in Electrical and Electronic Equipment (RoHS Directive 2011/65/EC) as far as they are subject to these regulations (for the RoHS Declaration of MOBOTIX, please see www.mobotix.com, Support > Download Center > Documentation > Brochures & Guides > Certificates).

Disposal

Electrical and electronic products contain many valuable materials. For this reason, we recommend that you dispose of MOBOTIX products at the end of their service life in accordance with all legal requirements and regulations (or deposit these products at a municipal collection center). MOBOTIX products must not be disposed of in household waste! If the product contains a battery, please dispose of the battery separately (the corresponding product manuals contain specific directions if the product contains a battery).

Disclaimer

MOBOTIX AG does not assume any responsibility for damages, which are the result of improper use or failure to comply to the manuals or the applicable rules and regulations. Our General Terms and Conditions apply. You can download the current version of the General Terms and Conditions from our website at www.mobotix.com by clicking on the corresponding link at the bottom of every page.

Notes on System Security

To protect the camera against security risks in data technology, the following measures are recommended after the installation has been completed:

MxManagementCenter:

- Menu **View > Wizards & Tools > Secure System:**
 - **Change camera factory default password:** ✓
 - **Enable encrypted HTTPS:** ✓
 - **Disable public access:** ✓
 - **User Management** (for all users):
 - **Force Complex Password:** ✓
 - **Logout on Inactivity:** After 5 min

User interface of the camera in the browser:

- **Admin Menu > Network Setup > Web Server:**
 - **Enable MxWeb:** –
 - **Enable intrusion detection:** ✓
 - **Notification threshold:** 10
 - **Timeout:** 60 minutes
 - **Block IP Address:** ✓

Notes on System Security

For more information on this new feature, please read the «Cyber Protection Guide» on www.mobotix.com (under Support > Download Center > Documentation > Brochures & Guides > Cyber Security).

Cleaning the Camera and Lenses

Clean the camera housing using a mild alcohol-free detergent without abrasive particles. To protect the lens protection glass, only use the supplied mounting supplies (see [MOBOTIX M73: Scope of Delivery, S. 20](#)).

Cleaning the lens protection glass

- Use the wide end of the gray module wrench (M.1) to remove/install the lens protection glass. The narrow side of the wrench is used to adjust the sharpness (focal length) of the tele lenses.
- You should clean the lens protection glasses and domes regularly using a clean, lint-free cotton cloth. If the dirt is more persistent, add a mild alcohol-free detergent without abrasive particles.
- Make sure you instruct cleaning personnel on how to clean the camera.

Drilling Template

Open this file in a PDF viewer (Acrobat Reader, Foxit Reader, or similar) and print the file **without scaling (original size)**.

Note

You can download the drilling template from the section [Drilling Template, S. 17](#) or on the MOBOTIX website: www.mobotix.com > [Support](#) > [Download Center](#) > [Marketing & Documentation](#) > [Drilling Templates](#)

Attention!

Always print or copy at 100% of the original size!

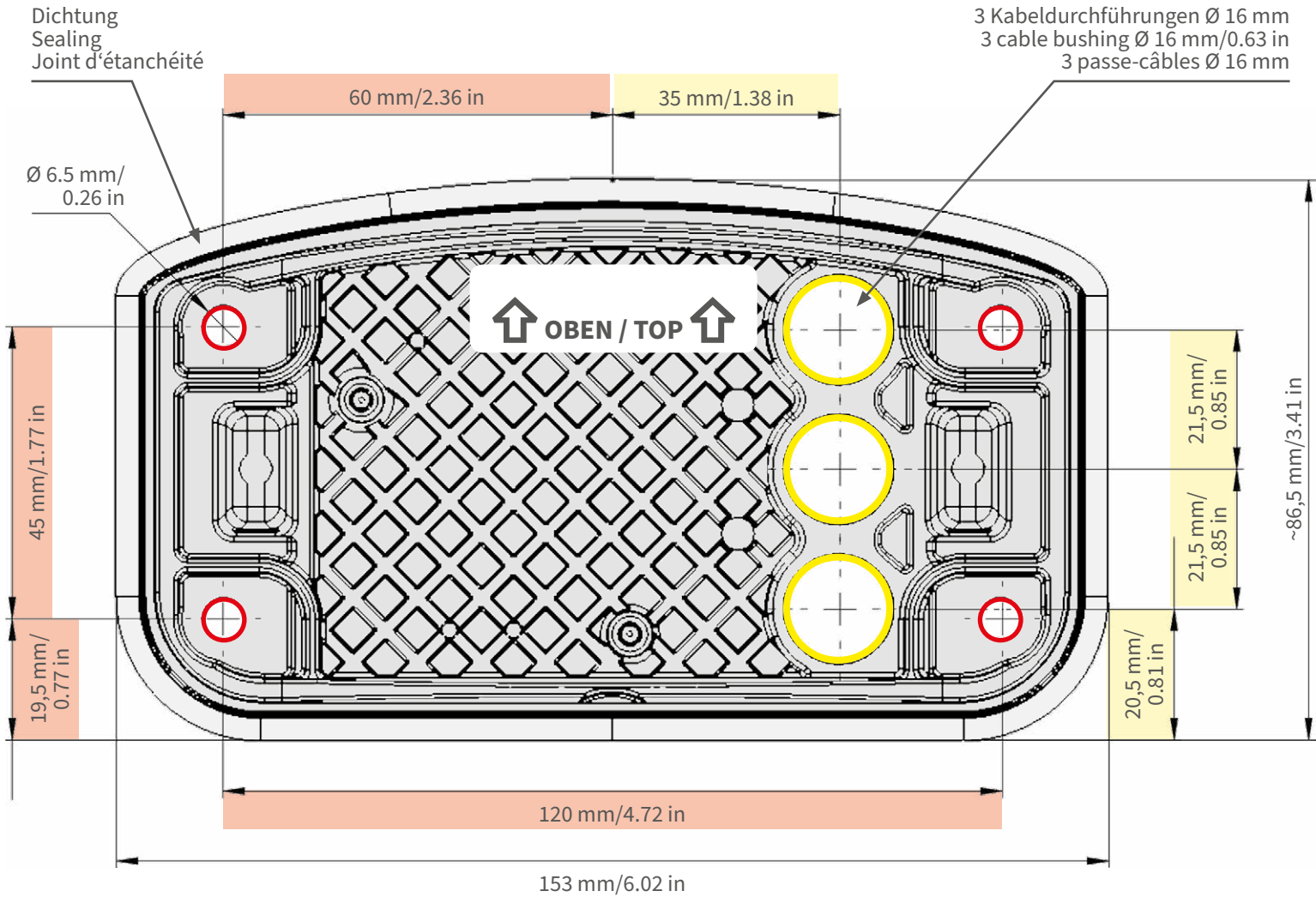

- Bohrungen für Befestigungsschrauben Ø 5 mm
- Holes for mounting screws 5 mm diameter
- Trous pour les vis de montage de 5 mm diamètre

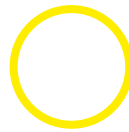

- Kabeldurchführungen Ø 16 mm
- Cable bushings 16 mm/0.63 in diameter
- Passe-câbles de 6 mm diamètre

Installation nur auf ebener Fläche! Unebenheiten dürfen 0,5 mm nicht überschreiten!

Installation only on level surface! Unevenness must not exceed 0.5 mm/0.02 in!

Montage uniquement sur une surface plane ! Les inégalités ne doivent pas dépasser 0,5 mm !



Nur in Originalgröße kopieren oder ausdrucken!

Always copy or print at 100% of original size!

Copier ou imprimer uniquement aux dimensions d'origine !

MOBOTIX, das MX Logo, MxControlCenter, MxEasy, MxPEG und MxActivitySensor sind in der Europäischen Union, den USA und in anderen Ländern eingetragene Marken der MOBOTIX AG • Änderungen vorbehalten • MOBOTIX übernimmt keine Haftung für technische Fehler, Druckfehler oder Auslassungen • Alle Rechte vorbehalten • © MOBOTIX AG 2019
www.mobotix.com > Support > Download Center > Dokumentation > Zertifikate & Konformitätserklärungen

MOBOTIX, the MX logo, MxControlCenter, MxEasy, MxPEG and MxActivitySensor are trademarks of MOBOTIX AG registered in the European Union, the U.S.A., and other countries • Information subject to change without notice • MOBOTIX does not assume any liability for technical or editorial errors or omissions contained herein • All rights reserved • © MOBOTIX AG 2019
www.mobotix.com > Support > Download Center > Documentation > Certificates & Declarations of Conformity

MOBOTIX, le logo MX, MxControlCenter, MxEasy, MxPEG et MxActivitySensor sont des marques déposées de MOBOTIX AG dans l'Union européenne, aux États-Unis et dans d'autres pays. • Sous réserve de modifications • MOBOTIX décline toute responsabilité concernant les erreurs techniques, les fautes d'impression ou les omissions • Tous droits réservés • © MOBOTIX AG 2019
www.mobotix.com > Support > Centre de téléchargement > Documentation > Certificats & Déclarations de conformité

MOBOTIX AG
Kaiserstrasse
D-67722 Langmeil
Germany
Tel.: +49 6302 9816-0
Fax: +49 6302 9816-190
info@mobotix.com / sales@mobotix.com
www.mobotix.com



MOBOTIX

Delivered Parts and Dimensions

MOBOTIX M73: Scope of Delivery



Abb. 1: Scope of delivery M73 Body

Scope of delivery M73 Body

Item	Count	Description
1.1	1	M73 Body with module housing, front plate and transport plugs, complete
1.2	1	Module housing
1.3	1	Front plate
1.4	3	Transport plug
1.5	1	Blind module (must be installed when using only two sensor modules)
1.6	1	Mounting plate with wall sealing (installed), two standard plugs (installed), and inserted connector box (see Scope of Delivery M73 Connector Box, S. 21)
1.7	1	MOBOTIX Ethernet patch cable, 50 cm/19.7 in with sealing
1.8	1	SD card 8 GB (installed)

Scope of delivery M73 Body**Item Count Description**

1.9	1	Mounting supplies (see Scope of Delivery M73 Mounting Supplies, S. 22)
1.10	1	Important Safety Information
1.11	1	Sticker with EAN number of camera
1.12	1	Sticker with IP address of camera

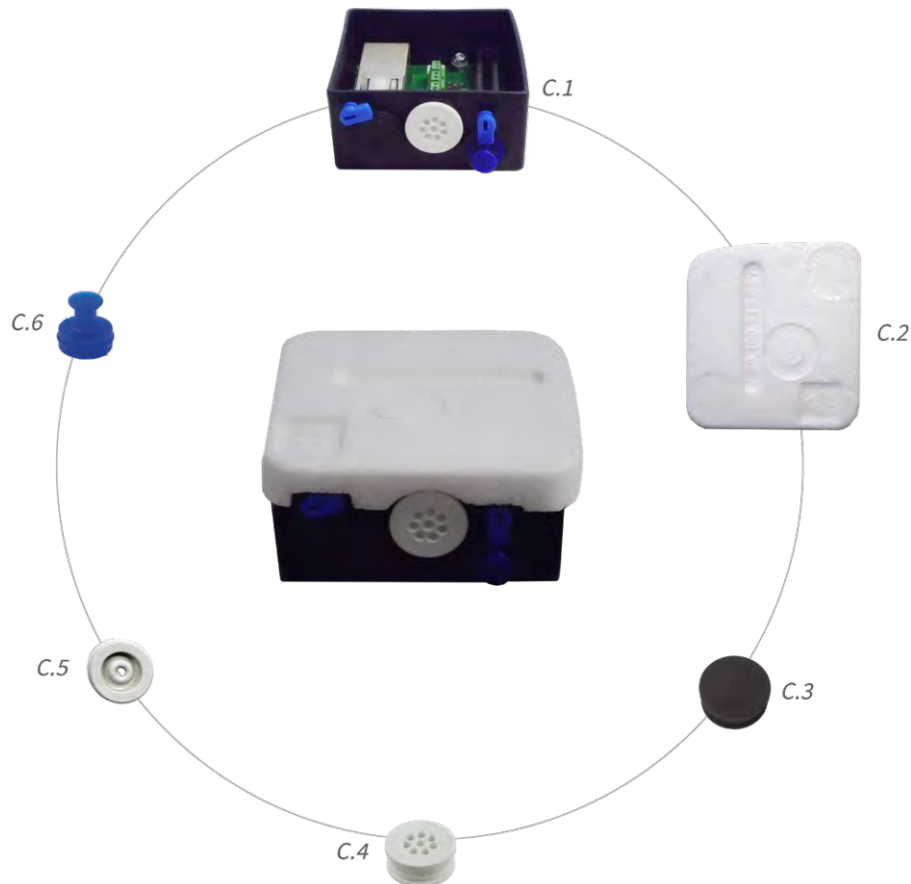
**Abb. 2: Scope of Delivery M73 Connector Box****Scope of Delivery M73 Connector Box****Item Count Description**

C.1	1	Connector box RJ45 black with rubber plug Ethernet black, rubber plug single-wire white, USB plug blue (installed)
C.2	1	Protective cover for connector box polystyrene white (installed)
C.3	1	Rubber plug Ethernet black (installed)
C.4	1	Rubber plug single-wire white (installed)
C.5	1	Rubber plug cable dia. 3.5 mm white (to replace C.5)
C.6	1	USB plug connector box blue (installed)

Delivered Parts and Dimensions

MOBOTIX M73: Scope of Delivery



Abb. 3: Scope of Delivery M73 Mounting Supplies

Scope of Delivery M73 Mounting Supplies

Item	Count	Description
M.1	1	Module wrench (gray)
M.2	1	Lens wrench blue
M.3	3	Housing plug silicone white
M.4	3	Security clips plastic red
M.5	2	Cable tie black
M.6	1	Allen wrench 5 mm
M.7	1	Allen wrench 2.5 mm
M.8	1	TORX wrench TX20
M.9	1	TORX wrench TX10
M.10	1	TORX wrench TX8
M.11	1	Screwdriver blue
M.12	4	Washer dia. 6.4 mm plastic white
M.13	4	Wood screw 4.5x60 mm

Scope of Delivery M73 Mounting Supplies

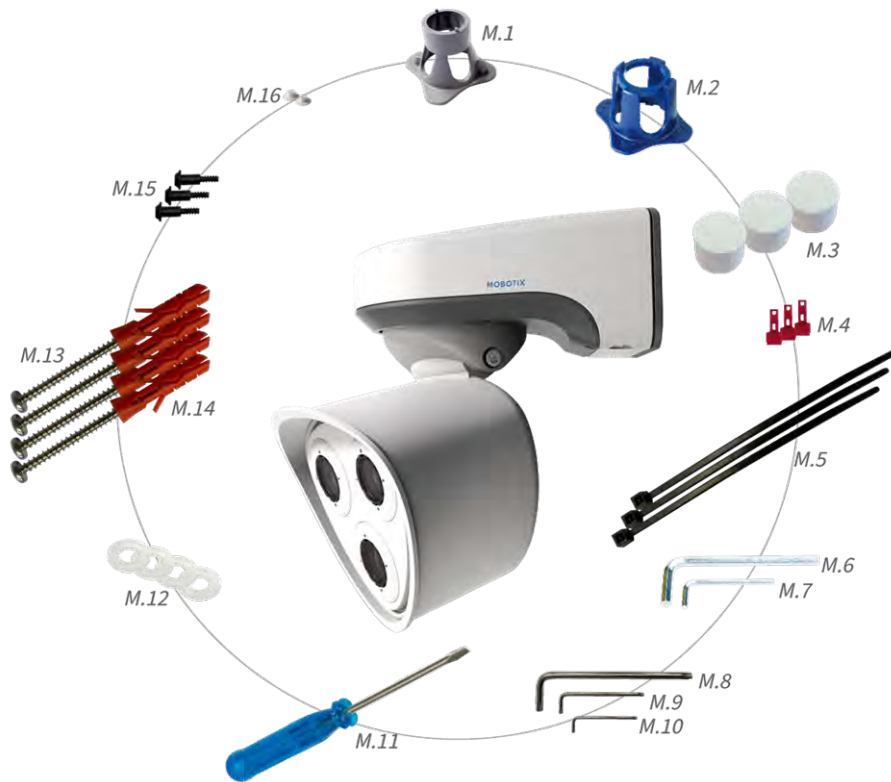
Item	Count	Description
M.14	4	Dowel S8
M.15	3	Oval head screw with shank 2.5x6.5 mm stainless steel black
M.16	2	Cover for screw plastic white

M73 – Dimensions

Note

You can download the drilling template from the section [Drilling Template, S. 17](#) or on the MOBOTIX website: www.mobotix.com > [Support](#) > [Download Center](#) > [Marketing & Documentation](#) > [Drilling Templates](#)

Attention!

Always print or copy at 100% of the original size!



Abb. 4: M73: All measurements in mm

10

Technical Specifications

Technical Specifications

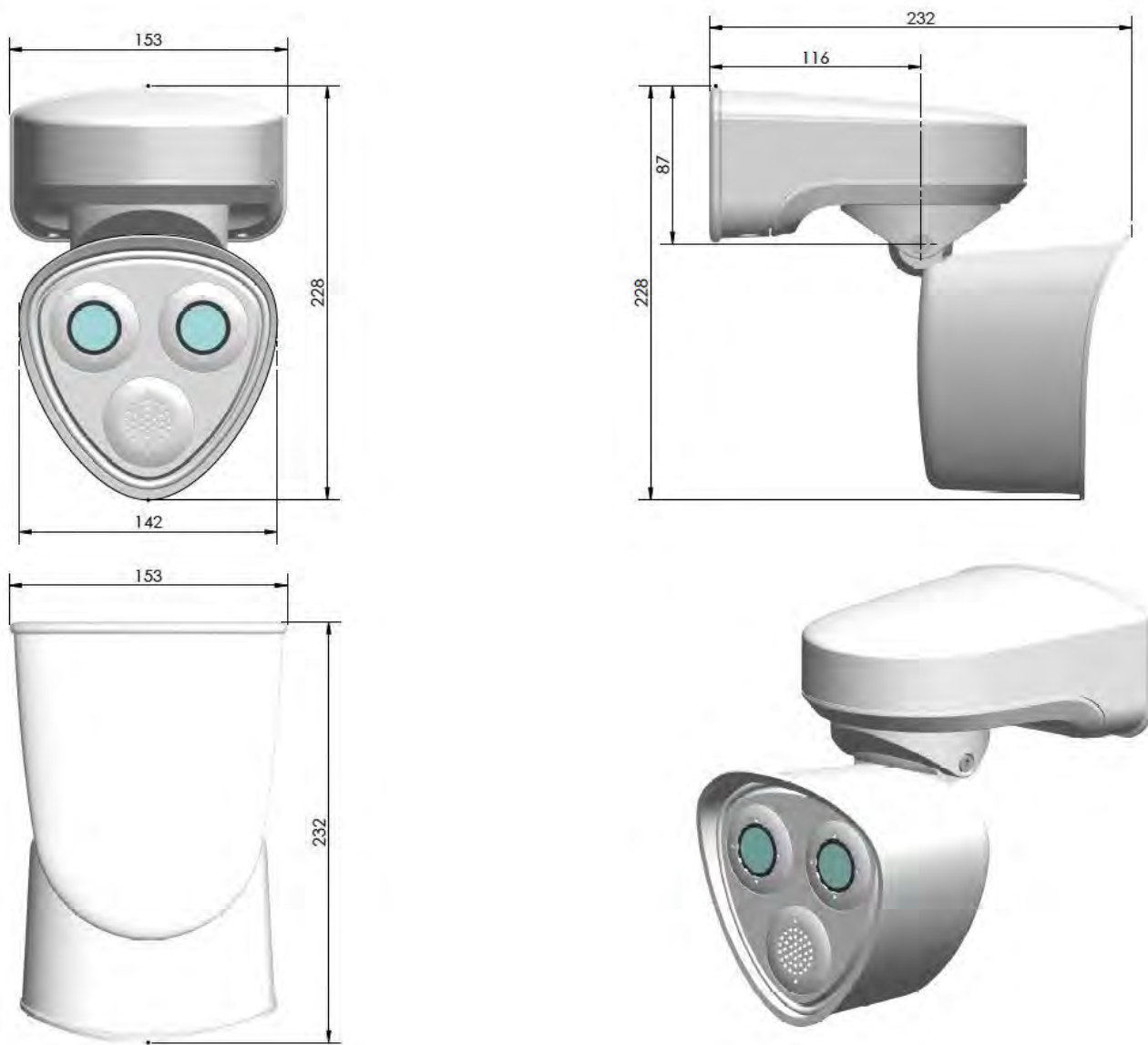
Hardware

Image sensor (color or B&W sensor)	4K UHD 3840x2160, 16:9, 1/1,8"
Light sensitivity	- Color sensor (day): 0,1 lx @ 1/60s; 0,005 lx @ 1s - BW sensor (night): 0,02 lx @ 1/60s; 0,001 lx @ 1s
Exposure control	Manual and automatic mode 1 s to 1/16,000 s
Video codecs	H.264, H.265 with Triple Streaming MxPEG+ MJPEG
IK protection class	IK10 (housing)
IP protection class	IP66
Ambient temperature (range, including housing)	-40 to 65 °C/-40 to 149 °F/95 % rel. humidity (non-condensing)
Internal DVR, out of the box	MicroSD card (8 GB), MxPEG+ recording only
I/Os	1 input/1 output (output requires external power supply)
Microphone/Speaker	Functional audio module, max. 4.5 Watt (see Supported functional modules, S. 32)
Passive infra-red sensor (PIR)	Available with functional module, max. 4.5 Watt (see Supported functional modules, S. 32)
Infra-red illumination	Three functional modules for wide-angle, standard, and tele lenses
Range of infra-red illumination	Up to 30 m/100 ft (may be more depending on scene)
Shock detector (tamper detection)	Yes
Max. power consumption	25 Watt
PoE standard	PoE Plus (802.3at-2009)/Class 4
Interfaces	Ethernet 1000BaseT miniUSB
Mounting Options	Wall- or pole-mountable (with Pole Mount accessory)
Dimensions (height x width x depth)	228 x 153 x 232 mm

Weight without sensor modules - Approx. 2.5 kg/5.5 lb

Housing	Aluminum, PBT-30GF
Standard accessories	See MOBOTIX M73: Scope of Delivery, S. 20
Tiltability of camera	Horizontal: 2 x 180 degrees Vertical: 110 degrees
Detailed technical documentation	www.mobotix.com > Support > Download Center > Marketing & Documentation
MTBF	80,000 hours
Certificates	EN 50121-4:2015, EN 50581:2012, EN 55032:2012+AC:2013, EN 55035:2017, FprEN 61000-6-1:2015, EN 61000-6-2:2015, EN 61000-6-3:2007+A1:2011+AC:2012, EN 61000-6-4:2007+A1:2011, EN 62368-1:2014 + AC: 2015 + A11: 2017 + AC: 2017, IEC 60950-22:2016, AS/NZS CISPR32:2015, 47 CFR Part 15b
Protocols	DHCP (client and server), DNS, ICMP, IGMP v3, IPv4, IPv6, HTTP, HTTPS, FTP, FTPS, NFS, NTP (client and server), RTP, RTCP, RTSP, SIP (client and server), SMB/CIFS, SNMP, SMTP, SSL/TLS 1.3, UDP, VLAN, VPN, Zeroconf/mDNS
Manufacturer warranty	3 years

Image formats, frame rates, image storage

Available video codecs	MxPEG+/MJPEG/H.264/H.265
Image resolutions	VGA 640x360, XGA 1024x576, HD 1280x720, FullHD 1920x1080, QHD 2560x1440, 4K UHD 3840x2160
H.264 multi streaming	Triple Streaming
Multicast stream via RTSP	Yes
Max. image resolution (dual image of both sensors)	4K UHD 3840x2160 (8MP)
Max. frame rate	MxPEG: 20@4K, H.264: 30@4K, H.265: 30@4K

Technical Specifications

General Features

WDR	Up to 120 dB
Software features	<ul style="list-style-type: none">- H.264, H.265 Multistreaming- Multicast stream via RTSP- Digital pan, tilt, zoom/vPTZ (up to 8x zoom)- Genetec protocol integration- Custom exposure zones- Snapshot recording (pre/post-alarm images)- Continuous recording- Event recording- Time-controlled flexible event logic- Weekly schedules for recordings and actions- Event video and image transfer via FTP and email- Playback and QuadView via web browser- Animated logos on the image- Master/Slave functionality- Privacy zone scheduling- Remote alarm notification (network message)- Programming interface (HTTP-API)- MOBOTIX MessageSystem
ONVIF compatibility	Profile S, T
Master/Slave functionality	Yes
Remote alarm notification	email, network message (HTTP/HTTPS), SNMP, MxMessageSystem
DVR/storage management (MxPEG+ only)	Within the camera via microSD card, on external USB and NAS devices, different streams for live image and recording, MxFFS with buffered archive, pre- and post-alarm images, storage monitoring with error reporting
Camera and data security	User and group management , SSL connections, IP-based access control, IEEE 802.1X, intrusion detection, digital image signature

Video Analysis

Video motion detection	Yes
MxActivitySensor	Version 1.0, 2.1 and object-based MxAnalytics AI
ONVIF compatibility	Profile S, T*
MxAnalytics	Heatmap, people counting & object-based counting
MOBOTIX App support	Yes

Video management software

MxManagementCenter	Yes (MxMC 2.2 and higher) www.mobotix.com > Support > Download Center > Software Downloads
MxBell	Yes www.mobotix.com > Support > Download Center > Software Downloads

Sensor module dimensions

Dimensions (height x width)	58 x 42.5 mm (dia. 50 mm)
--------------------------------	---------------------------

Features Thermal Sensors

Sensitivity thermal image sensor	Typ. 50 mK, IR range 7.5 to 13.5 μm ; Temperature Measurement Range: -40 to 550 $^{\circ}\text{C}$ / -40 to 1022 $^{\circ}\text{F}$
Image sensor: Thermal image sensor	Uncooled microbolometer, CIF: 336 x 256 pixels / VGA: 640 x 480
Max. image size MX sensor module	Can be scaled up to 3072 x 2048 (6MP), automatically scaled to size of MX sensor module
Max. frame rate Thermal image sensor	9 fps (when displaying an MX sensor module and a thermal sensor module, the overall frame rate of the camera is reduced to 9 fps)
Software (included)	Video management software MxManagementCenter

Supported sensor modules

Sensor module with Super Wide Lens 95° Mx-O-M7SA-8DN050
Mx-O-M7SA-8D050
Mx-O-M7SA-8N050

Sensor module with Wide Lens 60° Mx-O-M7SA-8DN080
Mx-O-M7SA-8D080
Mx-O-M7SA-8N080

Sensor module with Standard Lens 45° Mx-O-M7SA-8DN100
Mx-O-M7SA-8D100
Mx-O-M7SA-8N100

Sensor module with Tele Lens 30° Mx-O-M7SA-8DN150
Mx-O-M7SA-8D150
Mx-O-M7SA-8N150

Sensor module with Distant Tele Lens 15° Mx-O-M7SA-8DN280
Mx-O-M7SA-8D280
Mx-O-M7SA-8N280

Sensor module with Super Wide Lens 95° Mx-O-M7SA-8DN050
Mx-O-M7SA-8D050
Mx-O-M7SA-8N050

Sensor module with Wide Lens 60° Mx-O-M7SA-8DN080
Mx-O-M7SA-8D080
Mx-O-M7SA-8N080

Sensor module with Standard Lens 45° Mx-O-M7SA-8DN100
Mx-O-M7SA-8D100
Mx-O-M7SA-8N100

Sensor module with Tele Lens 30° Mx-O-M7SA-8DN150
Mx-O-M7SA-8D150
Mx-O-M7SA-8N150

Supported thermal sensor modules

Sensor module	Order code
CIF Thermal 45° x 35°	Mx-O-M7SA-336TS100
CIF Thermal 25° x 19°	Mx-O-M7SA-336TS150
CIF Thermal 17° x 13°	Mx-O-M7SA-336TS280
CIF Thermal Radiometry 45° x 35°	Mx-O-M7SA-336RS100
CIF Thermal Radiometry 25° x 19°	Mx-O-M7SA-336RS150
CIF Thermal Radiometry 17° x 13°	Mx-O-M7SA-336RS280
VGA Thermal 90° x 69°	Mx-O-M7SA-640TS050
VGA Thermal 69° x 56°	Mx-O-M7SA-640TS080
VGA Thermal 45° x 37°	Mx-O-M7SA-640TS100
VGA Thermal 30° x 26°	Mx-O-M7TA-640TS150
VGA Thermal Radiometry 90° x 69°	Mx-O-M7TA-640RS050
VGA Thermal Radiometry 69° x 56°	Mx-O-M7TA-640RS080
VGA Thermal Radiometry 45° x 37°	Mx-O-M7SA-640RS100
VGA Thermal Radiometry 30° x 26°	Mx-O-M7SA-640RS150

The **Thermal Radiometry** variants automatically alarm when the temperature exceeds or falls below defined limits. This is crucial for the detection of fire or heat sources. Up to 20 different temperature events can be configured simultaneously in so-called TR windows or over the complete sensor image over a temperature range of -40 to 550 °C/-40 to 1022 °F.

The **Thermal** variants only measure in the center of the image (2x2 pixel spotmeter).

Supported functional modules

Functional audio module	via IO Interface Board
-------------------------	------------------------

Functional MultiSense module	Mx-F-MSA PIR sensor, temperature sensor, illumination sensor, microphone
------------------------------	---

Functional IR Light Module	Mx-F-IRA-W for Super Wide Lens Sensor Modules 95° Mx-F-IRA-S for Standard & Wide Lens Sensor Modules 45° – 60° Mx-F-IRA-T for Tele Lens Sensor Modules 15° – 30°
----------------------------	--

Mounting

Attention!

Make sure to copy the IP address (1) on the back of the camera housing! You will need this address to configure the camera in the browser later on (see [Camera Software in the Browser, S. 91](#)).



Abb. 5: IP address on the back of the camera housing

The MOBOTIX M73 has been designed for wall mounting. Using the pole mount accessory, you can also install the camera on a pole (see [Mounting Options, S. 61](#)).

Note

You can download the drilling template from the section [Drilling Template, S. 17](#) or on the MOBOTIX website: www.mobotix.com > [Support](#) > [Download Center](#) > [Marketing & Documentation](#) > [Drilling Templates](#)

Attention!

Always print or copy at 100% of the original size!

Before Mounting the Camera

Before mounting the MOBOTIX M73, the following questions should be answered:

- Where will the camera be mounted?
- Is the mounting surface level?
- Which other mounting options are available?
- How is the camera connected to the network and how is the power supplied?
- How are the connections furnished from the building?
- What cabling considerations are necessary?

If you have questions, please ask your MOBOTIX partner directly or contact the MOBOTIX support under www.mobotix.com > **Support** > **Help Desk**.

Installation of the Sensor Modules

Upon delivery, the sensor module sockets in the front plate [1.3](#) are fitted with transport plugs [1.4](#). When operating the camera, it needs to be fitted either with sensor or blind modules [1.5](#). This closes off the front plate and protects the camera against foreign objects, animals and water.

The MOBOTIX M73 can be equipped with up to three sensor modules.

Do not operate the camera until all three receptacles have been fitted with sensor or blind modules.

Only replace the sensor modules when the camera is disconnected from the power supply. Make sure the power supply to the camera is disconnected before installing or replacing sensor modules.

When installing the sensor modules, make sure that the sensor module cables are not damaged or bent sharply.

Procedure

1. **Prepare the sensor module:** Remove the bayonet catch by rotating it counter-clockwise, then remove the blue rubber plug.

If the plastic nut has been installed, remove it.

This nut will **not** be used any more in the mounting process.



Abb. 6: Prepare sensor module for mounting; remove plastic nut!

Mounting

Installation of the Sensor Modules

2. **Remove the transport plugs:** Gently pull the transport plugs out of the sensor module receptacles and pull the plugs from the sensor module cables.

Attention

Only functional modules can be operated on the sensor module cable with the number 3. Both, optical and functional modules can be operated on the sensor module cables with the numbers 1 and 2.

Caution

Cautionously pull the sensor module cables out of the housing until you feel the stop!



Abb. 7: Remove the transport plugs

3. **Connect sensor module cable:** Push the plug of the sensor module cable firmly into the connector at the back of the sensor module.

Make sure that the catch on the sensor module connector fits into the notch of the sensor module.

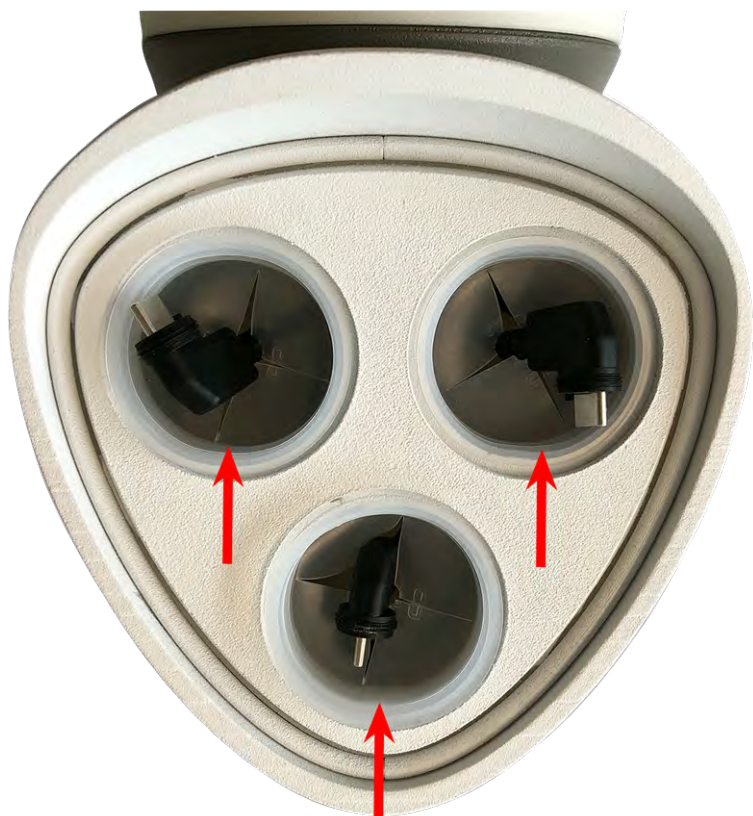

Abb. 8: Connect the sensor module cable

4. **Lock sensor module cable:** Apply the blue bayonet catch onto the connector of the sensor module as shown and turn it clockwise until it gently snaps shut.



Abb. 9: Lock sensor module

Mounting

Installation of the Sensor Modules

5. **Insert sensor module:** Push the sensor module into its receptacle. The arrow on the back of the module points to 9 o'clock when looking at the module as shown.



Abb. 10: Insert sensor module into module housing

6. **Lock the sensor module:** Using the gray module wrench [M.1](#), turn the sensor module clockwise until it stops.



Abb. 11: Lock the sensor module

If you cannot turn the sensor module, it has been inserted the wrong way! Remove the sensor module, rotate it by 180 degrees and insert it again.

7. Repeat steps 3 to 6 for the remaining sensor modules or the blind module [1.5](#), respectively.

Note that the sensor modules are not yet protected against theft and unwanted rotation (e.g., due to vibration). It is thus highly recommended to install the security clips [M.4](#). Proceed as outlined in the following:

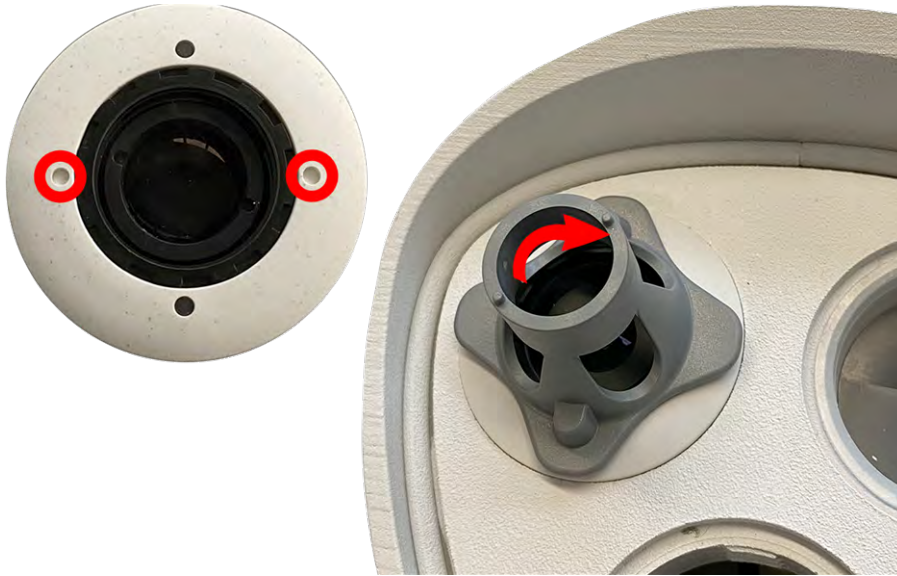

- [Opening the Module Housing, S. 49](#)
- [Installing the Security Clips, S. 44](#)
- [Closing the Module Housing, S. 58](#)

See also [MOBOTIX M73: Scope of Delivery, S. 20](#).

If you do **not** want to install the security clips, proceed by selecting the [Mounting Options, S. 61](#).

Opening the Module Housing

The following tasks require opening the module housing:

- Inserting security clips at the sensor module or the blind module, respectively.
- Exchanging a sensor or blind module.

Mounting

Installation of the Sensor Modules

- Replacing the default front plate [1.3](#) with a thermal front plate or vice versa.

Procedure

1. Remove the rubber plug at the back of the module housing (e.g., by using a small screwdriver).
2. Using the supplied 5 mm Allen wrench [M.6, S. 22](#), release the bolt at the back of the module housing. Leave the bolt and washer in the module housing.



Abb. 12: Opening the Module Housing

3. Using the allen wrench, **cautiously** push from behind onto the bolt and push the front plate out of the front of the housing.



Abb. 13: Default Front plate with sensor modules (back)

Installing the Security Clips

To prevent module rotation or removal it is highly recommended to install the security clips.

The security clips are protecting the sensor modules or the blind module in the front plate of the M73 against unwanted rotation (e.g., due to vibration when mounted on a pole or in an automotive scenario).



Caution!

Do not use the plastic nuts delivered with the sensor modules to lock the modules in place!



Abb. 14: Do not use plastic nut!

Procedure

1. Open the module housing (see [Opening the Module Housing, S. 49](#)).



Abb. 15: Groove for inserting the security clips; bore hole for oval head screw highlighted by red arrow

2. **Insert the security clips:** Insert a red security clip into the groove between the inner and the outer thread of the sensor module and press it all the way into the groove as shown in the image below.



Abb. 16: Insert security clip all the way

Mounting

Installation of the Sensor Modules

3. Use the oval head screw [M.15, S. 23](#) using the TORX wrench TX8 [M.10, S. 22](#) as shown in the figure.

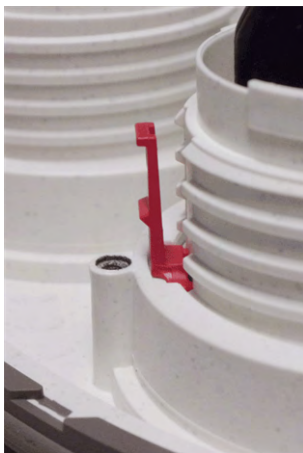
Make sure to keep oval head screw straight when fastening!



Abb. 17: Use screw to lock security clip in place

4. **Repeat steps 2 to 4:** apply security clips and screws to all modules.
5. **Close the module housing:** (see [Closing the Module Housing, S. 58](#)).

Closing the Module Housing

Insert the front plate of the M73 to close the module housing.

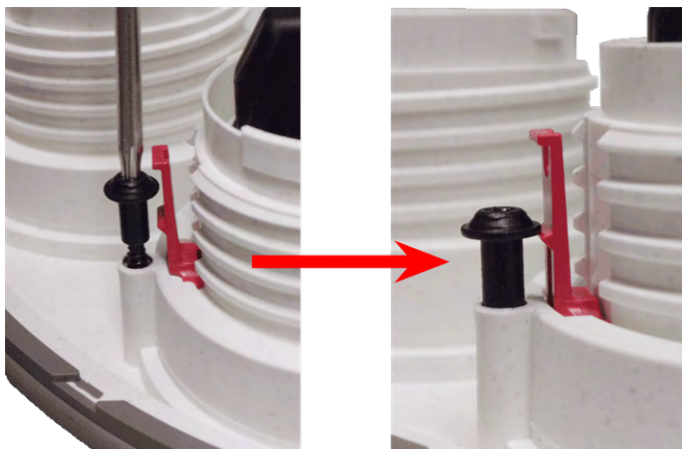
Procedure

1. Make sure that the arrow of the front plate (red circle in figure) points upwards when inserting the front plate into the module housing (figure shows front plate with cables removed).



2. Push the front plate into the module housing until it stops.



Mounting

Replacing the default front plate with a thermal front plate

3. Using the supplied 5 mm Allen wrench [M.6, S. 22](#), tighten the bolt at the back of the camera housing.
4. Push the rubber plug back into the opening of the screw to prevent humidity and dirt from entering the camera.



Replacing the default front plate with a thermal front plate

Upon delivery, two of three available sensor module sockets in the thermal front plate are fitted with transport plugs [1.4](#). When operating the camera, they need to be fitted either with sensor or blind modules [1.5](#). This closes off the front plate and protects the camera against foreign objects, animals and water.



Abb. 18: M73 Thermal Front Plate with thermal sensor module

Do not operate the camera until all three receptacles have been fitted with sensor or blind modules.

Only replace the sensor modules when the camera is disconnected from the power supply. Make sure the power supply to the camera is disconnected before installing or replacing sensor modules.

When installing the sensor modules, make sure that the sensor module cables are not damaged or bent sharply.

Opening the Module Housing

The following tasks require opening the module housing:

- Inserting security clips at the sensor module or the blind module, respectively.
- Exchanging a sensor or blind module.
- Replacing the default front plate [1.3](#) with a thermal front plate or vice versa.

Mounting

Replacing the default front plate with a thermal front plate

Procedure

1. Remove the rubber plug at the back of the module housing (e.g., by using a small screwdriver).



2. Using the supplied 5 mm Allen wrench [M.6, S. 22](#), release the bolt at the back of the module housing. Leave the bolt and washer in the module housing.



Abb. 19: Opening the Module Housing

3. Using the allen wrench, **cautiously** push from behind onto the bolt and push the front plate out of the front of the housing.



Abb. 20: Default Front plate with sensor modules (back)

Removing the Security Clips

To prevent module rotation or removal it is highly recommended to install the security clips.

The security clips are protecting the sensor modules or the blind module in the front plate of the M73 against unwanted rotation (e.g., due to vibration when mounted on a pole or in an automotive scenario).



Procedure

1. **Open the module housing** (see [Opening the Module Housing, S. 49](#)).
2. **Remove the security clips:** Push the security clip slightly towards the sensor module and pull it out of its seat.



Abb. 21: Remove a security clip

3. Repeat steps 1 and 2 to remove the other security clips.

To remove the sensor modules see [Removing the Sensor Modules, S. 51](#).

Removing the Sensor Modules

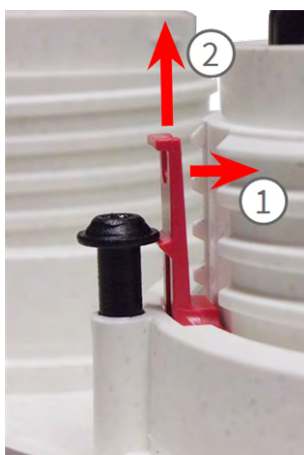
In some cases, e.g., when replacing modules, you need to remove the sensor modules. It's the same procedure for both, the default front plate and the thermal front plate.

Do not operate the camera until all three receptacles have been fitted with sensor or blind modules.

Only replace the sensor modules when the camera is disconnected from the power supply. Make sure the power supply to the camera is disconnected before installing or replacing sensor modules.

Mounting

Replacing the default front plate with a thermal front plate

When installing the sensor modules, make sure that the sensor module cables are not damaged or bent sharply.

Procedure

1. **Remove security clips:** If any security clips are installed, remove them (see [Removing the Security Clips, S. 51](#)).
2. **Unlock sensor module cable:** Turn the blue bayonet catch counterclockwise from the connector of the sensor module until it releases and remove it.



Abb. 22: Unock sensor module

3. **Remove sensor module cable:** Pull the plug of the sensor module cable from the connector at the back of the sensor module.



Abb. 23: Remove the sensor module cable

Mounting

Replacing the default front plate with a thermal front plate

4. **Remove sensor module:** Pull the sensor module from its receptacle.



Abb. 24: Remove sensor module from the module housing

5. Repeat steps 1 to 3 for the remaining sensor modules.

Installing the Sensor Modules

1. **Prepare the sensor module:** Remove the bayonet catch by rotating it counter-clockwise, then remove the blue rubber plug.

Caution!

If the plastic nut has been installed, remove it.

This nut will **not** be used any more in the mounting process.



Abb. 25: Prepare sensor module for mounting; remove plastic nut

- 2. Remove the transport plugs:** Gently pull the transport plugs out of the sensor module receptacles and pull the plugs from the sensor module cables.

Attention!

Only functional modules can be operated on the sensor module cable with the number 3. Both, optical and functional modules can be operated on the sensor module cables with the numbers 1 and 2.

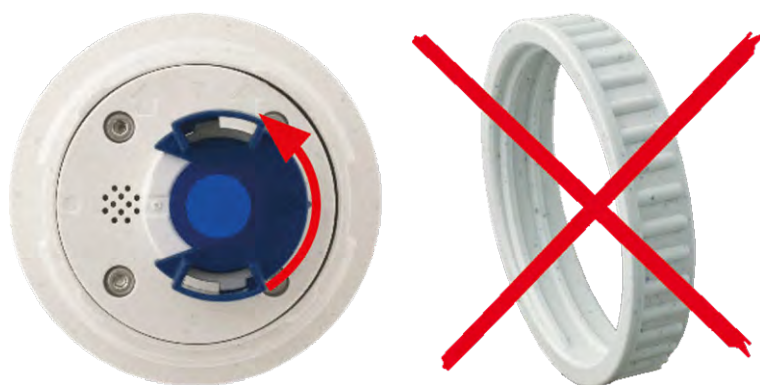
Caution

Cautiously pull the sensor module cables out of the housing until you feel the stop!



Abb. 26: Remove the transport plugs

Mounting

Replacing the default front plate with a thermal front plate

3. **Connect sensor module cable:** Push the plug of the sensor module cable firmly into the connector at the back of the sensor module.

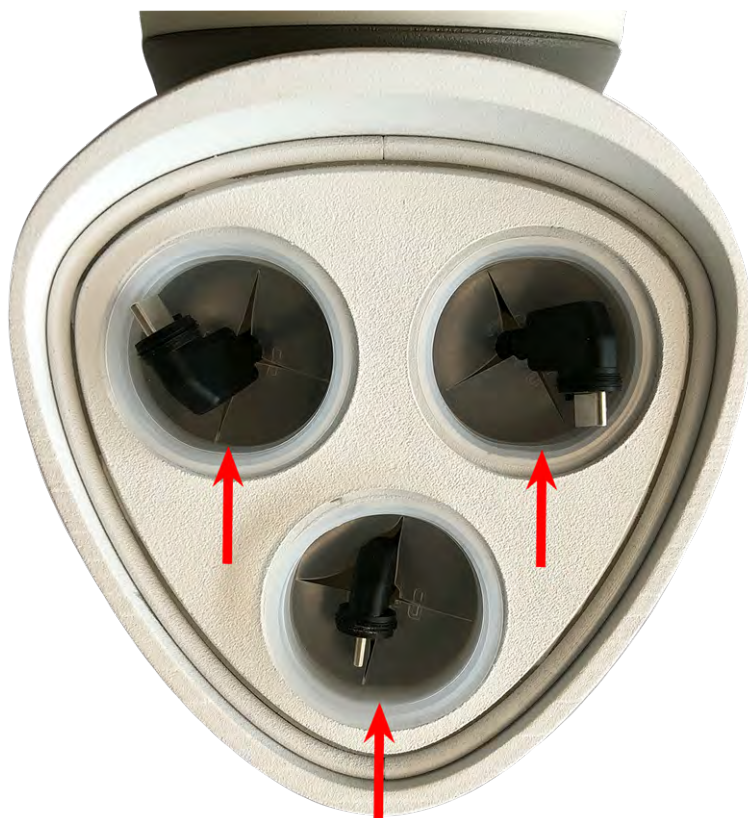
Make sure that the catch on the sensor module connector fits into the notch of the sensor module.



Abb. 27: Connect the sensor module cable

4. **Lock sensor module cable:** Apply the blue bayonet catch onto the connector of the sensor module as shown and turn it clockwise until it gently snaps shut.



Abb. 28: Lock sensor module

5. **Insert sensor module:** Push the sensor module into its receptacle. The arrow on the back of the module points to 9 o'clock when looking at the module as shown.



Abb. 29: Insert sensor module into module housing

Mounting

Replacing the default front plate with a thermal front plate

6. **Lock the sensor module:** Using the gray module wrench [M.1](#), turn the sensor module clockwise until it stops.



Abb. 30: Lock the sensor module

Attention!

If you cannot turn the sensor module, it has been inserted the wrong way! Remove the sensor module, rotate it by 180 degrees and insert it again.

7. Repeat steps 3 to 6 for the remaining sensor modules or the blind module [1.5](#), respectively.

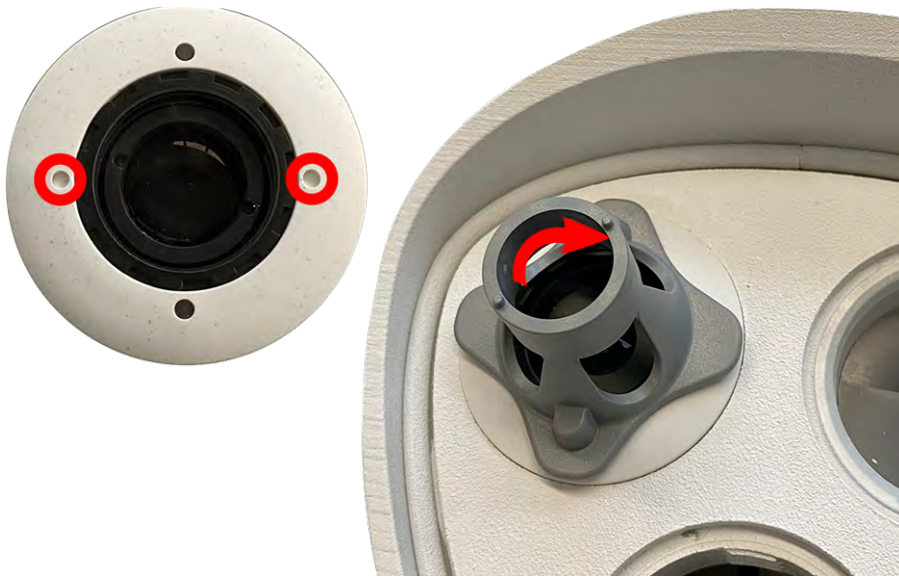
Note

The sensor modules are not yet protected against theft and unwanted rotation (e.g., due to vibration). It is thus highly recommended to install the security clips [M.4](#). Proceed as outlined in the following:



- [Opening the Module Housing, S. 49](#)
- [Installing the Security Clips, S. 44](#)
- [Closing the Module Housing, S. 58](#)

See also [MOBOTIX M73: Scope of Delivery, S. 20](#).

If you do **not** want to install the security clips, you can proceed with [Closing the Module Housing, S. 58](#).

Closing the Module Housing

Insert the front plate of the M73 to close the module housing.

Procedure

1. Make sure that the arrow of the front plate (red circle in figure) points upwards when inserting the front plate into the module housing (figure shows front plate with cables removed).



2. Push the front plate into the module housing until it stops.



Mounting

Replacing the default front plate with a thermal front plate

3. Using the supplied 5 mm Allen wrench [M.6, S. 22](#), tighten the bolt at the back of the camera housing.
4. Push the rubber plug back into the opening of the screw to prevent humidity and dirt from entering the camera.



Mounting Options

You can mount the M73 to any even surface on a wall or to poles with up to 180 mm/7.1" diameter using the stainless steel pole mount that is available as accessory. The concealed cabling improves security of the installation.

Caution!

Installation only on flat surface! Unevenness must not exceed 0.5 mm/0.02 in!

The [mounting plate C.1](#) has been dimensioned to fully cover conventional flush-mounted sockets (without frame) or cavity sockets.

Note

Before mounting the camera, determine its ideal position and make sure that the field of view is not obstructed in any way. Once the camera has been mounted, you can fine-tune the image. If the monitored area changes or the camera has to be installed in a different location, you can simply exchange the sensor modules.

Caution!

Please only use genuine MOBOTIX patch cables to guarantee the weatherproofness!

Mounting to a Wall

Before mounting the camera, make sure that a network connection with power supply according to the PoE Plus (802.3at-2009) standard is available at the mounting position (see [Connecting the Camera, S. 65](#)).

Note

You can download the drilling template from the section [Drilling Template, S. 17](#) or on the MOBOTIX website: www.mobotix.com > [Support](#) > [Download Center](#) > [Marketing & Documentation](#) > [Drilling Templates](#)

Attention!

Always print or copy at 100% of the original size!

Do not use the dowels if the installation surface is wood. Only use the screws to fasten the mounting plate directly on the surface. In order to facilitate screwing in wood, the positions should first be predrilled using a 2 mm drill bit, for example (drilling depth just slightly less than screw length).

Tiltability when mounted to a wall:

- horizontally: 2 x 180 degrees
- vertically: 110 degrees



Abb. 31: Tiltability when mounted to a wall

Procedure

1. **Drill the holes:** Mark the holes for drilling using the drilling template (see [Drilling Template as PDF](#)). When drilling, use a suitable 8 mm drill bit and drill holes with at least 60 mm/1.2" depth. Fully push the dowels [M.14](#) into the holes you drilled.

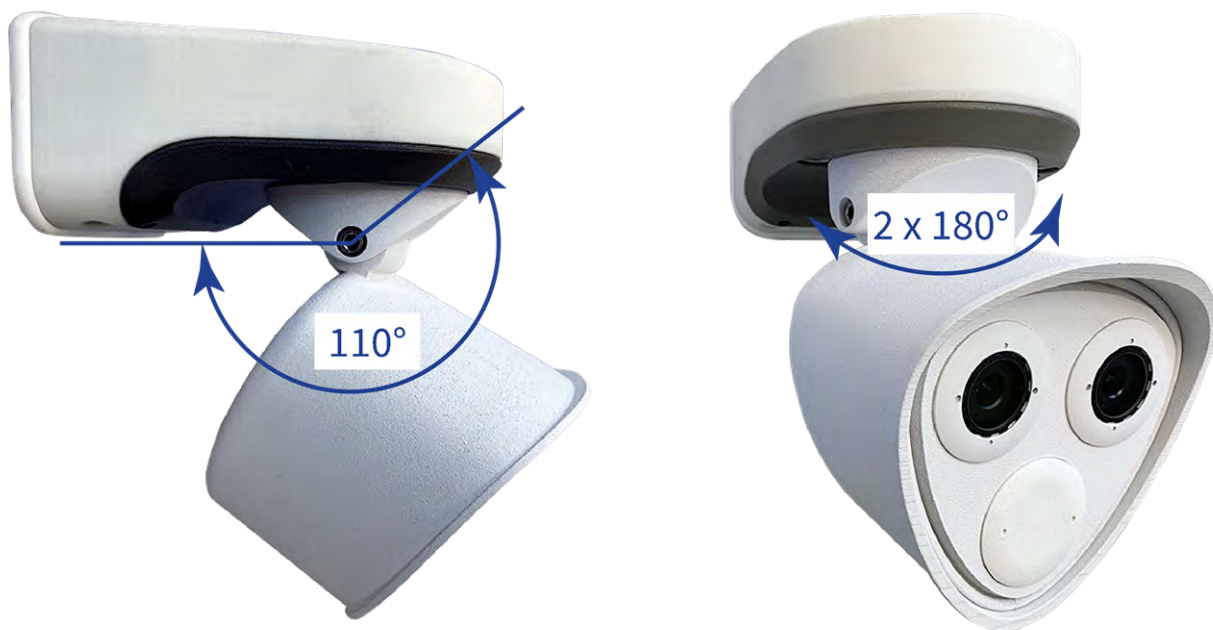

Abb. 32: Mounting plate with holes for positioning the fastener screws

2. **Prepare mounting plate and network connection:** Connect the patch cable 1.7 of the camera with the network connection of the building (see [Mounting to a Wall, S. 61](#)).

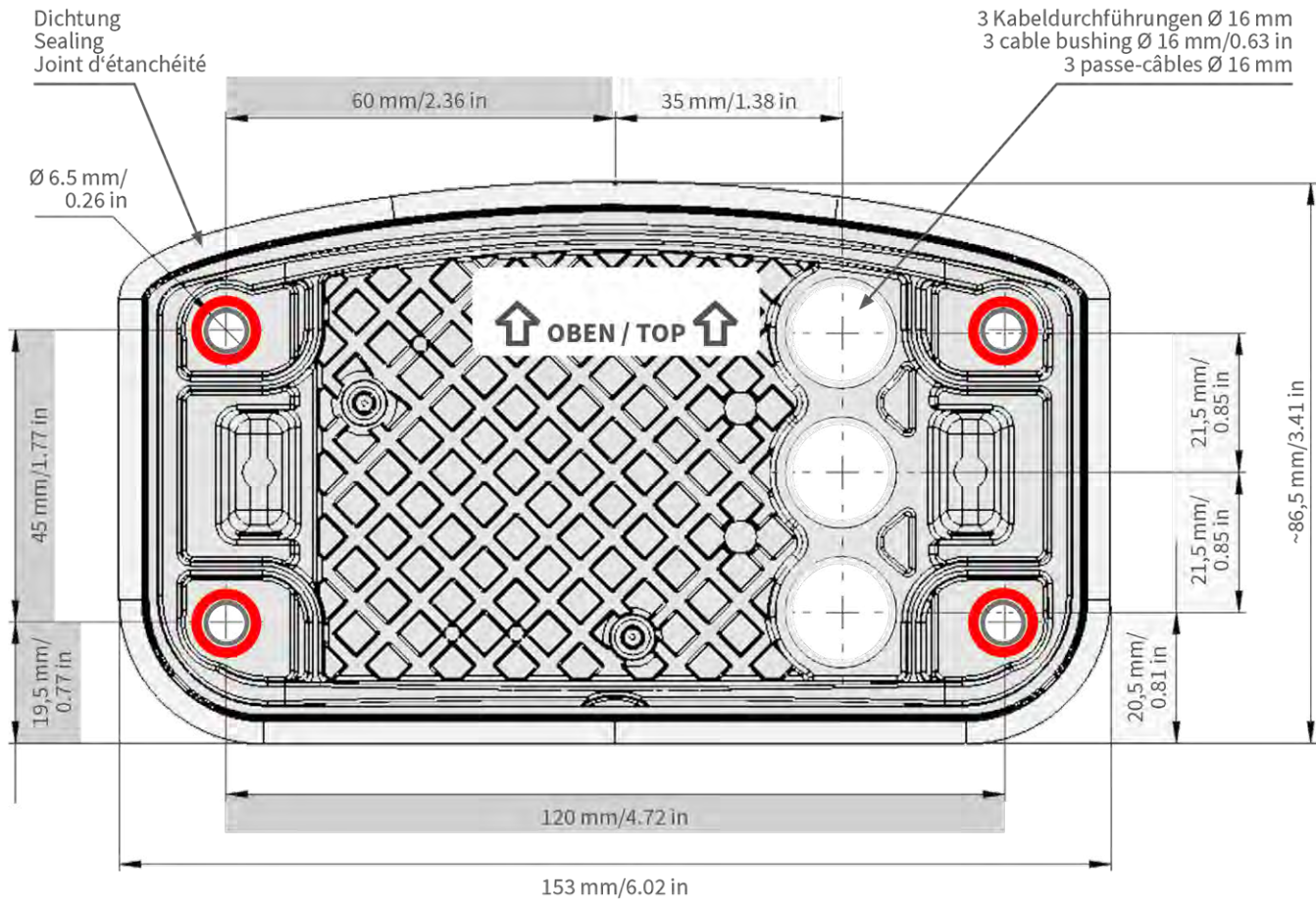

Abb. 33: Network connection of the M73

Mounting

Mounting Options

3. **Prepare the mounting plate:** The supplied network cable 1.7 has an integrated rubber sealing. Push the network cable through the bottom hole of the mounting plate, that the funnel of the rubber plug (1) points toward the camera.



Abb. 34: Prepare the mounting plate

4. **Install the mounting plate:** Place the mounting plate over the drilled holes (1) and use the four screws M.13 with one washer M.12 each and the M.8, S. 22 to mount the plate to the wall.

Caution! Installation only on flat surface! Unevenness must not exceed 0.5 mm/0.02 in!

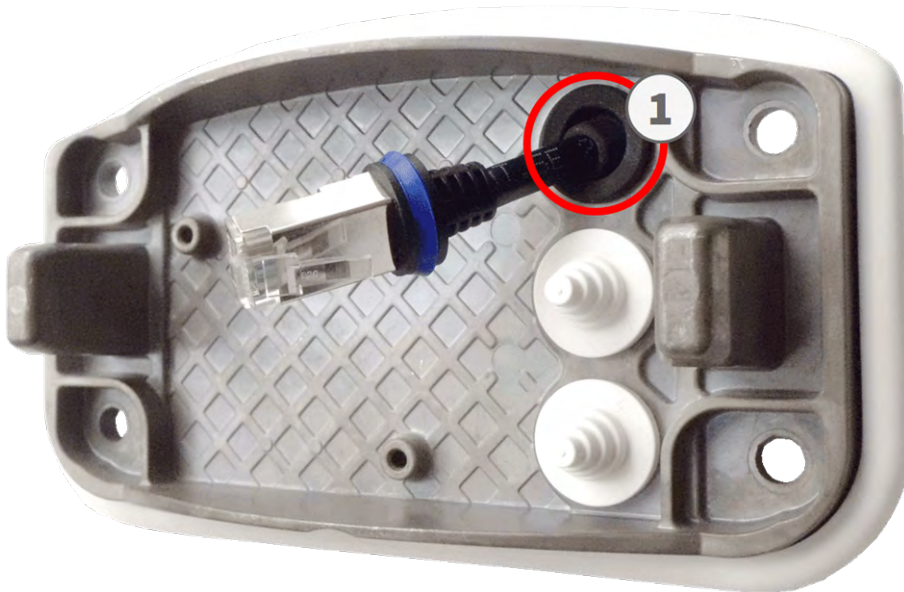

Abb. 35: Mounting plate installed on wall

Connecting the Camera

All connections of the camera (network, power supply, inputs/outputs) are established via the [connector box C.1](#). When mounting the camera onto the [mounting plate 1.6](#), the camera will be connected automatically. A PoE switch provides the camera's power supply.

Important to know:

- The PoE switch must provide Class 4 according to PoE Plus (802.3at-2009) as well as the 100/1000 Mbps Ethernet interface of the camera.
- It is highly recommended to use an uninterruptible power supply (UPS) for the switch.
- The maximum length of the network cable for remotely supplying power is 100 m (300 ft).



Abb. 36: Power supply using PoE switch according to PoE Plus (802.3at-2009)

Connecting the Connector Box



Abb. 37: Connector box with rubber plug Ethernet C.3 (1), rubber plug single-wire C.4 (2), USB plug (3) and two blue locks

Procedure

1. Remove the black plug from the network connector (1).
2. Plug the supplied [network cable of the camera 1.7](#) into the network connector (1) of the connector box.
3. Connect the other wires/cables as required (inputs/outputs, USB).
4. Secure the connector of the network cable by turning the blue lock clockwise as shown:

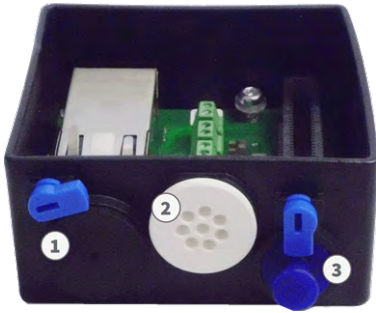

Abb. 38: Lock the network cable in the connector box

5. Using the [TORX wrench TX10 M.9](#) and the two pre-mounted screws (highlighted red in the figure), fixate the connector box on the mounting plate:

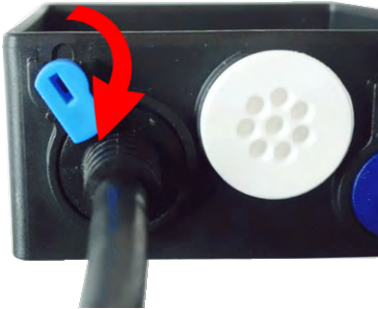

Abb. 39: Mounting the connector box (top view) using the two screws (highlighted red in the figure) on the mounting plate

Caution: Make sure that the connector box is properly fastened on the mounting plate as shown above. Failing to do so could damage the mainboard of the camera!

Continue with [Finishing the Installation of the Camera, S. 68](#).

Finishing the Installation of the Camera

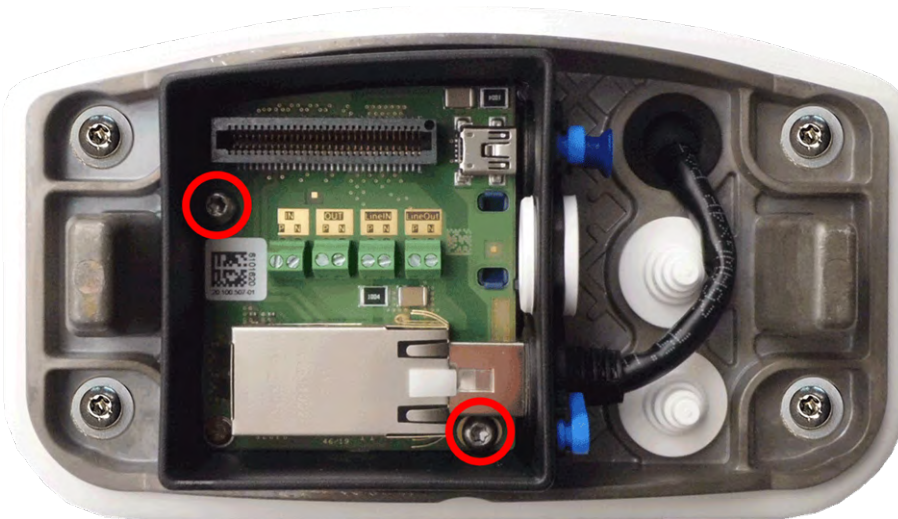
To finish the installation of the M73, the entire camera is mounted onto the mounting plate using the two lock screws. The connections of the camera are established automatically. The installation is finished by applying the remaining cover plugs to ensure the water-proofness of the housing.

You will need:

- Allen wrench 5 mm [M.6](#)
- 2 housing plugs silicone white [M.3](#)
- 2 caps for screw plastic white [M.16](#)



Abb. 40: Attach the camera on the mounting plate to complete the mounting of the camera

Procedure

1. Press the camera body onto the installed mounting plate, so that the wall sealing snugly seals off the camera body.



Abb. 41: Press camera onto mounting plate

2. Tighten the two Allen screws using the Allen wrench M.6.



Abb. 42: Tighten Allen screws

Mounting

Finishing the Installation of the Camera

3. Insert the two housing plugs M.3 firmly into the holes of the fastening screws.



Abb. 43: Apply rubber plugs

4. Roughly point the camera into its direction of view.
5. Fixate the camera by tightening the two Allen screws (1, panning) and the two Allen screws (2, tilting) of the center pivot.

To properly point the camera into the desired direction of view, read the section [Adjusting the Camera](#).



Abb. 44: Fastening the Camera

6. Press the two covers M.16 onto the two Allen screws (2, upper figure) of the center pivot.



Abb. 45: Properly installed M73

Operating the Camera

Getting Started

You can use the M73 with any current browser – or with MxManagementCenter. You can download MxManagementCenter free-of-charge from www.mobotix.com > [Support](#) > [Download Center](#) > [Software Downloads](#).

Procedure

1. **Connect the camera to the network.** The network cable will also provide power to the camera (see [Connecting the Camera, S. 65](#)).
2. **Establish a connection to the camera and adjust the network settings if required:** By factory default, MOBOTIX cameras are booting as DHCP client with an additional fixed IP address in the 10.x.x.x range (e.g., 10.16.0.128). Local computer networks usually have IP addresses in the 172 or 192 ranges. Depending on whether a DHCP server is present on the local network or if the network has been set up to use fixed IP addresses, there are several possibilities for establishing a connection to the camera and to change its [Network Settings, S. 77](#):
 - **Network with dynamic IP addresses**

Using a browser: If you know the IP address that the DHCP server assigned to the camera, simply enter that address in the browser address bar to directly connect to the camera

Using MxManagementCenter: With MxManagementCenter, you can show and integrate the camera without having to know its current IP address.
 - **Network with static IP addresses**

In order to access the camera, it must have an IP address within the range of the local network. To set the camera's network parameters, you can use one of these methods:

Manually using a web browser: You may have to adjust the network settings of your computer.
 - **Automatically using MxManagementCenter:** The camera is displayed in MxManagementCenter although the IP address is not part of the local network, allowing you to reconfigure its settings.
3. **Configure camera:** You can use the user interface of the camera in a browser or in MxManagementCenter.

Boot Options of the Camera

By default, the camera starts as DHCP client and automatically tries to get an IP address from a DHCP server. To start the camera in a mode different from the default mode, you can activate the boot menu of the camera.



Abb. 46: View of the M73 from below with LED (1) and screw with sealing (2) that hides the key inside the camera body

Hint: Pressing the key of the camera will let the camera announce the current IP address of the camera on the speaker (if a speaker is attached to the camera).

Procedure

1. Prepare the camera:

- Disconnect the camera's power supply.
- Remove the Allen screw (2) using the Allen wrench 2.5 mm [MOBOTIX M73: Scope of Delivery, S. 20](#). Take care not to lose the plastic washer.
- To press the key, use a paper clip for example, but never use sharp or pointed objects.
- Reconnect the power supply of the camera.

2. **Activate the boot menu:** The red LED lights up 5 to 10 seconds after establishing the power supply and will stay on for 10 seconds. Press the key by inserting the paper clip into the hole (red circle in the figure). The camera enters the boot menu, ready for selecting one of the boot options. The LED will flash once. The flash signal will be repeated every second.

The number of flashes corresponds to the current boot option.

3. **Switch the boot option:** Briefly press the key (< 1 sec). After the last boot option, the camera returns to the first boot option (LED flashes once).

LED flashes	Boot Option	Meaning	Audio Confirmation*
1x	•/•	This option is not supported on this camera model.	•/•
2x	Factory Defaults	Starts the camera with factory defaults (factory default IP address, users and passwords will not be reset).	Boing
3x	Automatic IP Address	Starts the camera as DHCP client and tries to obtain an IP address from a DHCP server. If a DHCP server cannot be found or no IP address can be obtained, the camera starts with its factory default address.	Boing-Boing
4x	Recovery System	Starts the camera with the recovery system, e.g., in order to recover from a failed update of the camera software.	Alarm Sound

*Only on cameras with audio option and installed speaker.

4. **Select a boot option:** Press the key longer (> 2 sec). The camera confirms the selection by flashing the LED rapidly for 3 seconds. After 20 sec, the camera will play a sound according to the table above.
5. Insert the Allen screws and the plastic washer using the Allen wrench 2.5 mm M.7 and take care not to over-tighten the screw.

If you do not select a boot option, the camera will resume its normal boot process after a certain time.

Starting the Camera With Factory Defaults or an Automatic IP Address (DHCP)

The configurations loaded when using the boot options 2 and 3 will not be automatically saved to the camera's flash memory. Upon starting the camera the next time, the camera will use the last configuration it stored. You can store the configuration in the camera's flash memory using the **Admin Menu > Store** command. Note that you can restore specific parts of the camera configuration afterwards by using "Restore" to re-apply the settings still stored in the camera.

As opposed to resetting the camera using **Admin Menu > Reset configuration to factory defaults**, the user information will not be reset if the camera is booted using the factory defaults.

When starting the camera with DHCP support (option 2), make sure that the network has a properly functioning DHCP server. If this is not the case, the camera cannot obtain a valid IP address and will fall back to its last IP address.

You should also make sure that the cameras always get the same IP addresses by mapping the MAC addresses of the cameras to the desired IP addresses.

Network Settings

Once the camera has been connected to the network, you need to set up the MOBOTIX camera's network interface accordingly. This step involves setting up and checking the network parameters of the camera. If your network has an active DHCP server or if it is already running on a 10.x.x.x network with a 255.0.0.0 network mask) you do not need to change the camera's network parameters. You can directly access the camera. If neither your network nor your computer use an IP address in the 10.x.x.x network (e.g. a 192.168.x.x or 172.x.x.x network), you should follow one of the following methods for changing the camera's network parameters:

- Manual setup
- Automatic setup using MxManagementCenter

For the following examples, we will use a camera with the factory IP address 10.16.0.99. Replace this IP address with the IP address of your camera. You will find this address on a small sticker on the camera. Make sure that the IP addresses used in the following examples are not used by any other devices on your network.

Windows 8.1/10



Abb. 47: Network settings on Windows machines

1. Open the Windows **Control Panel** > **Network and Internet** > **Network and Sharing Center** > **Change Adapter Settings** > **Ethernet**.
2. Right-click on the relevant network adapter and select **Properties**.

3. Open the properties of **Internet Protocol Version 4 (TCP/IPv4)**.

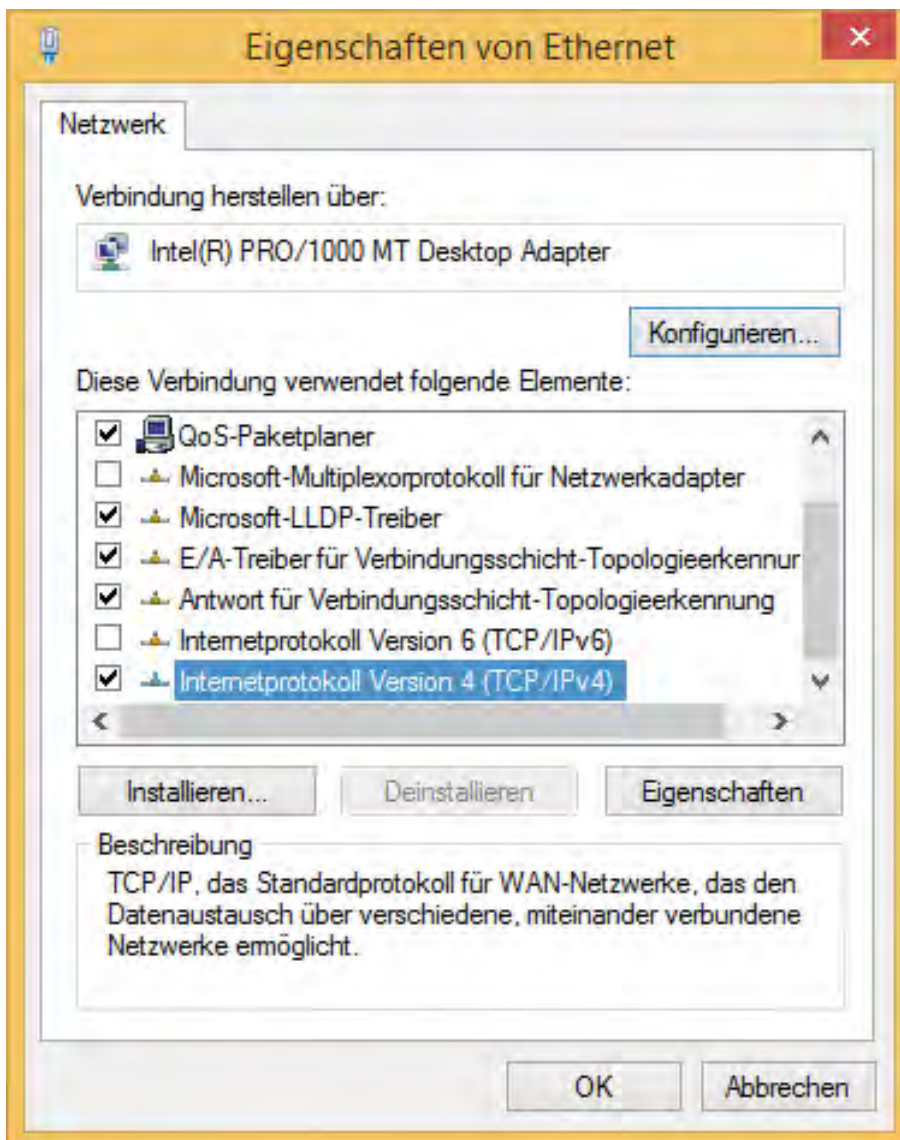

Abb. 48: Properties of Internet Protocol V4

4. Activate **Use the following IP-address**. Enter an IP address in the 10.x.x.x range in this field (e.g. 10.16.0.11).
5. Click on **OK** to apply the settings.

Linux/Unix

1. Open a terminal as `root` user.
2. Enter the following command: `ifconfig eth0:1 10.16.0.11`.
3. The computer now has the additional IP address 10.16.0.11.

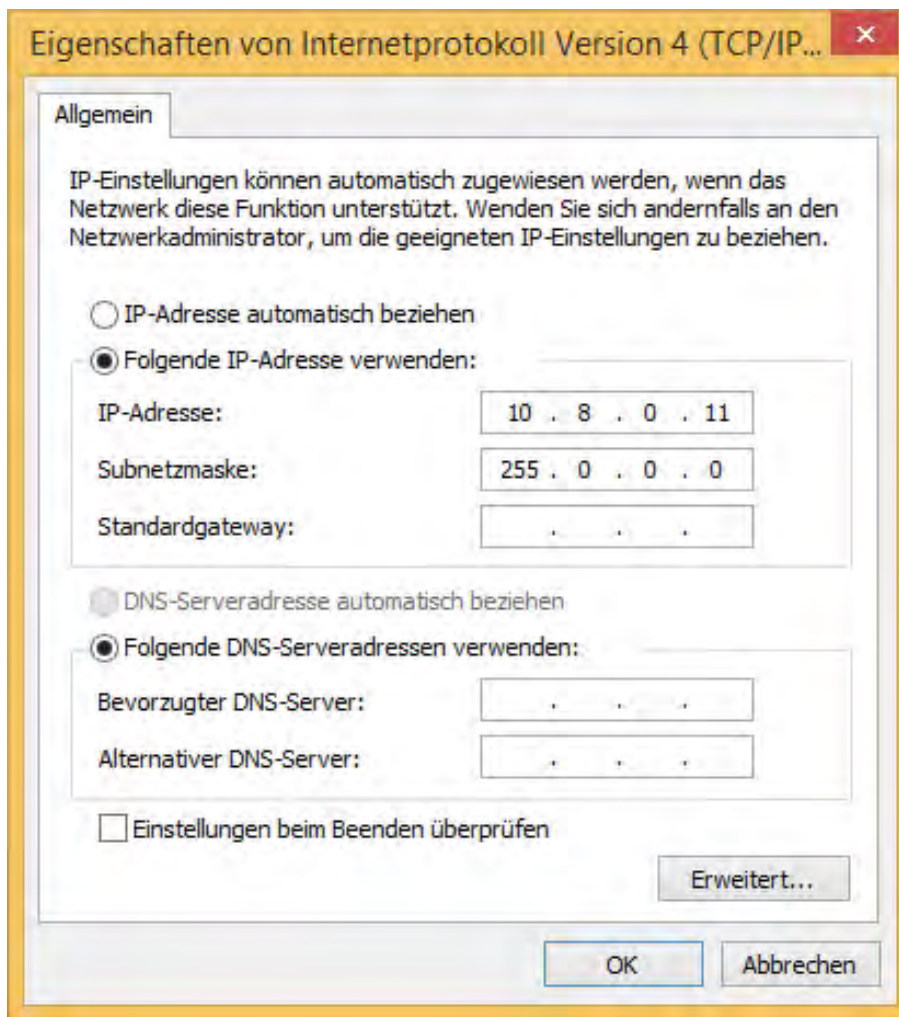
macOS



Abb. 49: Network settings on macOS machines

1. Open **System Settings > Network**.
2. Click on **Ethernet** and in the **Configuration** field, select the *Manual* list entry and enter an IP address in the 10.x.x.x IP address range (e.g., 10.16.0.11).
3. Click on **Apply** to apply the settings.

MOBOTIX Camera in the Browser

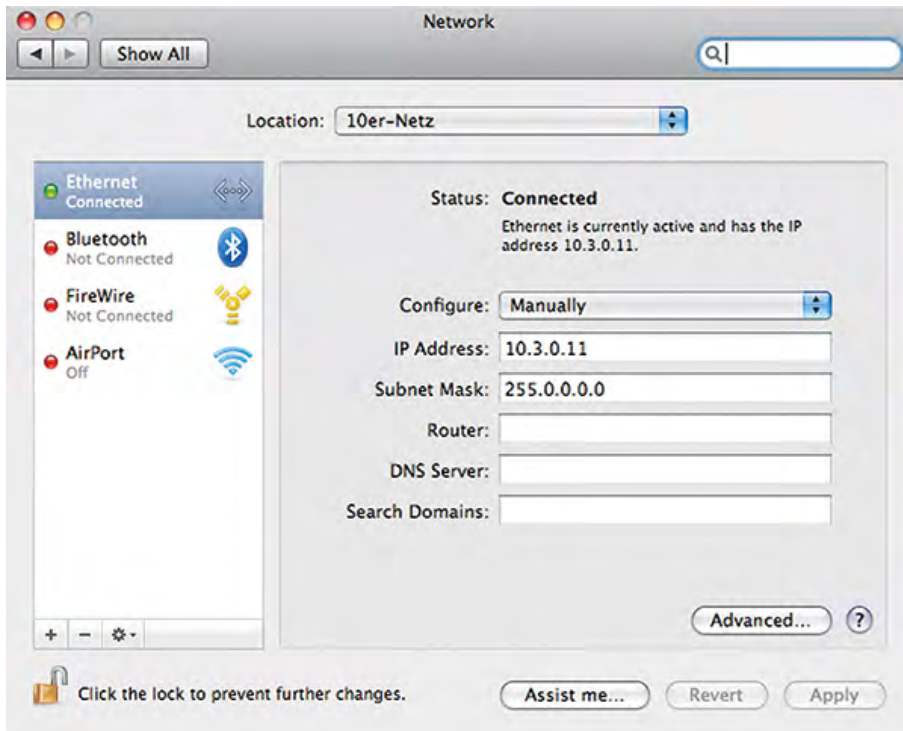

Abb. 50: Network settings in the web interface of the camera

1. Use a web browser to access the web interface of the MOBOTIX camera and enter the factory IP address (e.g., 10.16.0.99).
2. Click on the **Admin Menu** button in the user interface of the camera. The Quick Installation automatically starts after entering the access credentials of the admin user.

Factory access credentials:

User name: admin

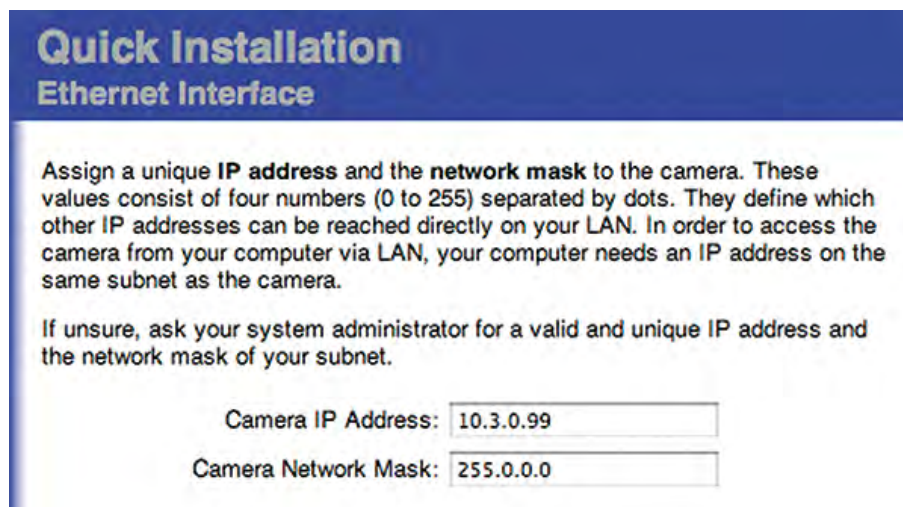
Password: meinsm

Note:

You can also run the Quick Installation later on (**Admin Menu > Network Configuration > Quick Installation**; see Reference Manual).

3. Enter the network parameters of the camera in the course of the quick installation.

Note:

You can also change the network parameters later on by running **Admin Menu > Network Configuration > Quick Installation**.

4. Reboot the camera to apply the network settings.

MOBOTIX Camera in MxManagementCenter

MxManagementCenter is a video management software for setting up and using the entire video surveillance system that provides a range of functions for different tasks and user groups. You can download the newest release of MxManagementCenter from the MOBOTIX website (www.mobotix.com > Support > Download Center > Software Downloads, MxManagementCenter section).

Please refer to the MxManagementCenter help for more information.

Procedure

When starting MxManagementCenter for the first time, the configuration wizard opens and automatically starts searching for MOBOTIX cameras. The number of found cameras is shown as a counter next to the **Add Devices** icon. This number is updated automatically if the number of MOBOTIX cameras on the network has changed (i.e., by connecting new/disconnecting existing cameras).

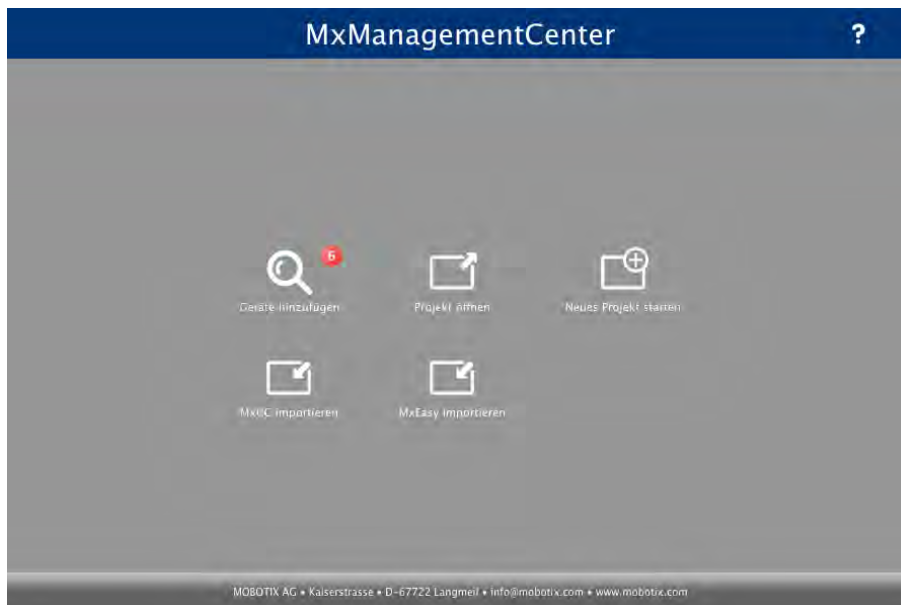

Start screen of the MxManagementCenter

1. Click on **Add Devices**. The cameras are displayed either in a list or as tiles. Use the List and Tile buttons to change the display mode.





Abb. 51: Cameras as list

Operating the Camera

Network Settings

The application automatically monitors and displays the operating status of all cameras using corresponding icons. Example:

-  The camera is not in the same subnet as the computer.
-  The user name and password of the camera are not known.

Using the Bonjour service ([en.wikipedia.org/wiki/Bonjour_\(software\)](https://en.wikipedia.org/wiki/Bonjour_(software))), the application finds not only MOBOTIX cameras on the same subnet, but also in other subnets. Normally, you would not be able to establish any connection to cameras in a different network or subnet.

This is the case, for example, if you are integrating cameras into a network without DHCP server (i.e., with fixed IP addresses) and the IP address range is different from the 10.x.x.x range supported by the cameras in addition to DHCP.

MxManagementCenter can automatically configure such a camera so that it is "integrated" into your existing network.

2. Select the camera you want to set up and click on **Edit Network Settings**  at the bottom of the program window. The **Change Network Settings for Selected Devices** dialog opens.



Abb. 52: Change Network Settings for Selected Devices

3. Enter the IP address and the subnet mask of the selected camera.

The IP addresses of the other cameras are automatically incremented by 1.

4. Click on **Apply** to apply the settings.

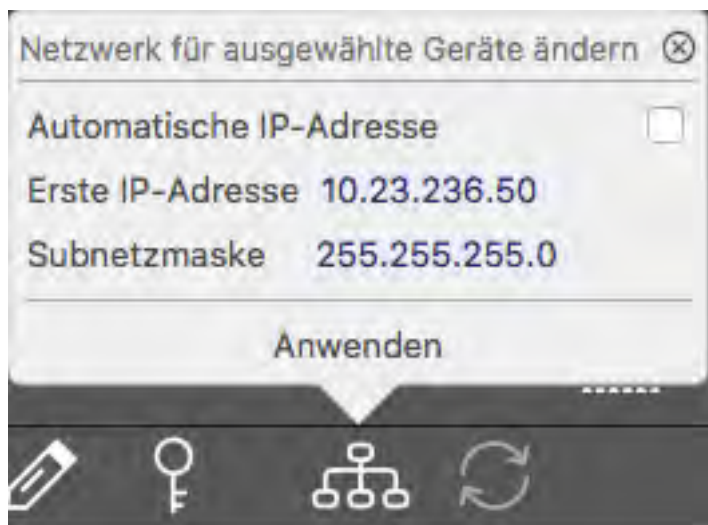
For more information on this feature, please read the MxManagementCenter online help or the Tutorial (see www.mobotix.com > Support > Download Center > Documentation > Brochures & Guides > Tutorials).

Adjust the Camera

Adjusting the camera at the mounting position will ensure that you will see the desired field of view later on.

When adjusting the image focus or the field of view of the camera, always make sure that you can see the live image of the camera!

To properly adjust the camera



Abb. 53: Adjusting the camera

1. Show the live image of the camera on monitor (For more information, please consult the Reference Manual of the camera.).
2. Remove the screw caps if they have already been installed.
3. Using the Allen wrench [M.6](#), loosen the screw (1) on both sides of the center pivot so that you can easily tilt the module housing.
4. Using the Allen wrench [M.6](#), loosen the screws (2) that lock the center pivot so that you can easily turn the module housing.
5. Display the desired camera section on the computer monitor, then turn and tilt the camera until you have found the best position and sharpness.
6. Tighten the screws (1) and (2) to lock the camera in place.
7. If required, clean the optical surfaces using a clean, lint-free cotton cloth.

Focusing the TELE 15° Sensor Module

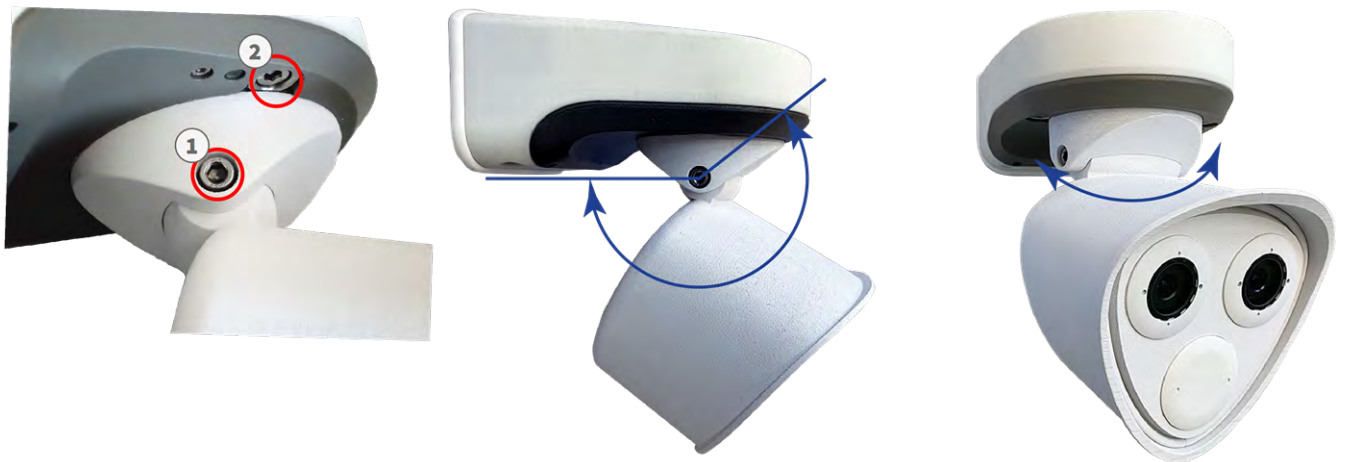

Abb. 54: Module wrench **M.1**, S. 22 and lens wrench **M.2**, S. 22 of the M73

Once the camera has been mounted, the **TELE 15° sensor module** should be checked for proper sharpness. You will need the **lens wrench blue M.2** and the **module wrench gray M.1** that are part of the [MOBOTIX M73: Scope of Delivery](#), S. 20.

When adjusting the image focus or the field of view of the camera, always make sure that you can see the live image of the camera!

To correct image sharpness, you can also make use of the visual **focusing aid** of the camera (see the **Camera Reference Manual**, section **The Live View of the MOBOTIX Camera**)

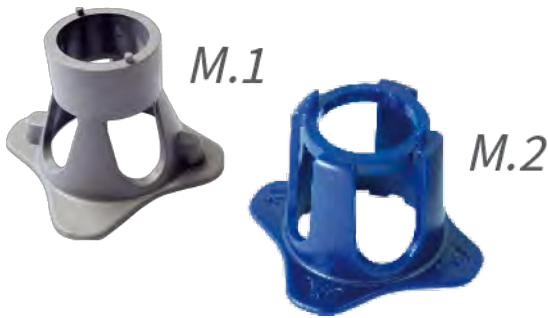
Focusing the Camera Lenses

1. Show the live image of the camera on your monitor.
2. Insert the blue lens wrench into the notches of the sensor module.
3. Turn the wrench counter-clockwise until it stops:



Abb. 55: Turn sensor module counter-clockwise until it stops

Caution:

If the red security clips M.14 have not been installed, the sensor module will also rotate! If this happens, keep on turning until the sensor module stops in its position for removal.

4. Rotate the wrench to the left until the lens protection glass slides out of the sensor module.
5. Insert the gray module wrench (with its two small pins) into the holes of the lens and cautiously turn to the left and to the right. Adjust the image sharpness according to the live image on the computer monitor:



Abb. 56: Adjust lens focus

Operating the Camera

Focusing the TELE 15° Sensor Module

Caution:

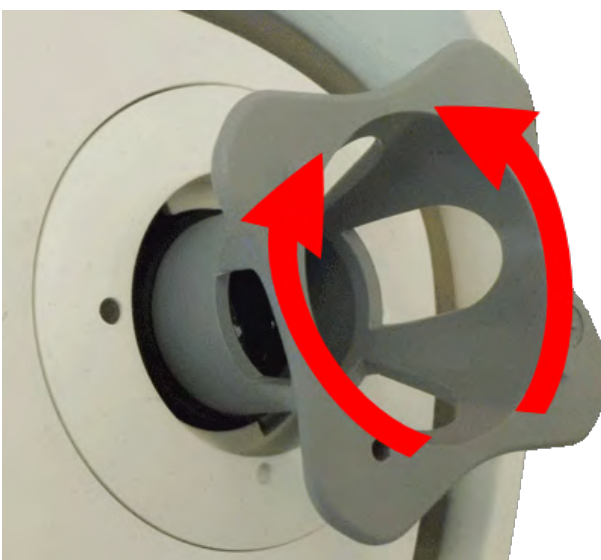
Never apply force when turning the lens and never screw the lens too deep into the thread since this could damage the image sensor! If in doubt, keep turning the lens counter-clockwise, then turn clockwise to focus the lens.

6. If required, clean the inside of the lens protection glass with a clean, lint-free cloth:



Abb. 57: Lens protection glass

7. Set the lens protection glass onto the notches of the blue lens wrench and position the protection glass with its two prongs over the corresponding receptacles of the sensor module:



Abb. 58: Insert lens protection glass using the lens wrench

- Using the lens wrench, press the lens protection glass firmly into the sensor module, until the glass fits flush with the sensor module housing.

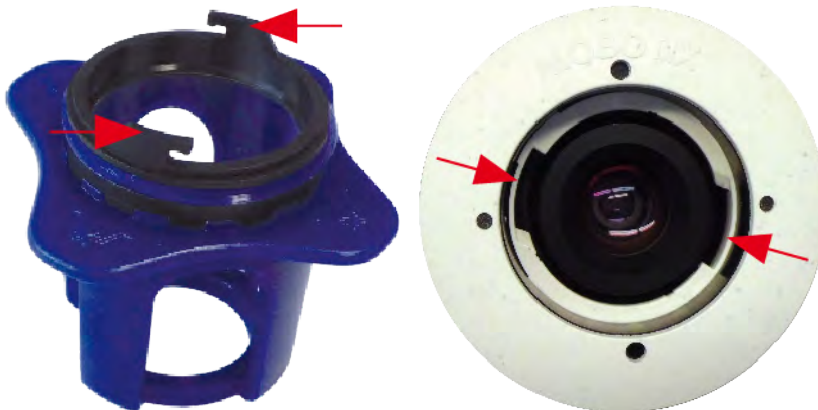

Abb. 59: Push hard to insert lens protection glass and turn to lock

- Turn the lens protection glass clockwise using the blue lens wrench until it locks in place.
- If required, clean the outside of the lens protection glass with a clean, lint-free cloth:

Note:

After adjusting the focus, make sure that the sensor module is aligned properly and that it is locked in place (use the gray module wrench to turn the sensor module clockwise until it stops).

Camera Software in the Browser

Once the power and network connection of the MOBOTIX have been established, you can open the interface of the camera software in a web browser.



Abb. 60: The interface of the camera software

Default access credentials for the Administration Menu:

User name: admin

Password: meinsm

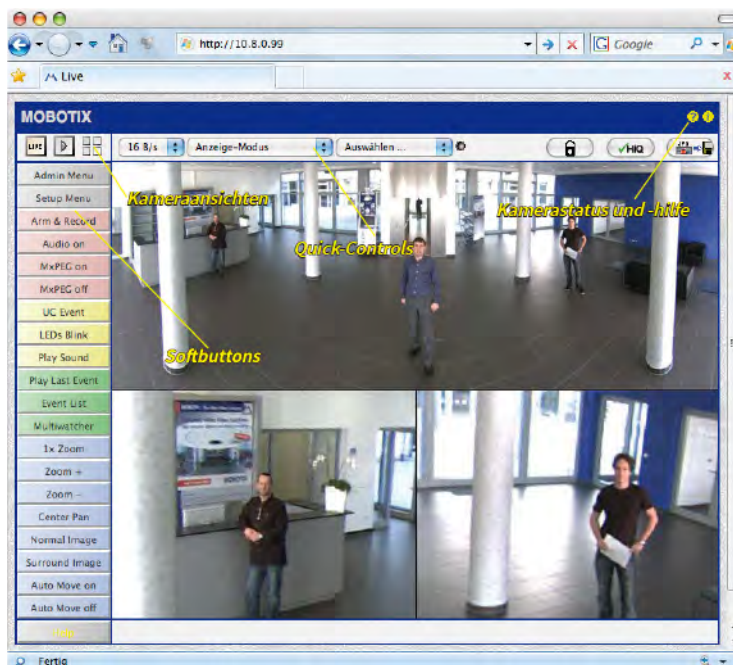
You must change the password when logging in for the first time

Open the camera's website in the browser

1. Enter the camera's IP address in the address field of a web browser.

Make sure to copy the IP address camera from the back of the camera housing or from the sticker M.12.

Basic Settings

Password for the Administration Menu: Accessing the administration area of the camera (Admin Menu button) in the browser is only possible after entering a user name and password.

- **Default user name:** admin
- **Default password:** meinsm

You must change the password when logging in for the first time.

Make sure that you store information on user names and passwords in a secure place. If you lose the administrator password and cannot access the Administration menu, the password can only be reset at the factory. This service is subject to a service charge.

The Quick Installation wizard will appear automatically when accessing the Administration Menu for the first time. It provides an easy method to adjust the basic camera settings to the current application scenario. For security reasons, it is highly recommended to change the default administrator password after the camera has been configured properly.

Enter the user name and password exactly as shown above. Note that all entries are case-sensitive.

Administering the camera: You can modify the camera configuration in the Administration Menu or the Setup Menu:

- **Admin Menu:** This menu contains the basic configuration dialogs of the camera (e.g. passwords, interfaces, software update).
- **Setup Menu:** This menu contains the dialogs for configuring the image, event and recording parameters. Some of these settings can be changed using the corresponding Quick Controls in the Live screen.

For more information, please consult the Reference Manual of the camera.

Configuring Sensor Modules

Using different combinations of sensor modules of the MOBOTIX M73 will have an influence on the display modes and configuration variants that are available.

An M73 will automatically check and verify the installed sensor modules upon its first start and at every reboot thereafter (e.g., focal length, Day or Night variant). Please note the following:

- If only one sensor module is attached, the camera will behave like a mono camera (i.e., there is no automatic Day/Night switching).
- If the modules are not exchanged within the first 12 operating hours, the camera will store the information of new sensor modules in the camera configuration.
- The camera will check the configuration on every reboot to see if the stored sensor modules are still present. If changes of the sensor module configuration have been detected (e.g., if a sensor module had to be replaced), the camera will show a corresponding message in the live image.

If required, the module configuration can be adjusted, e.g. you can define in which camera image (left or right) the sensor module should be displayed in a double image display. Open the **Admin Menu > Image Sensor Configuration** dialog:

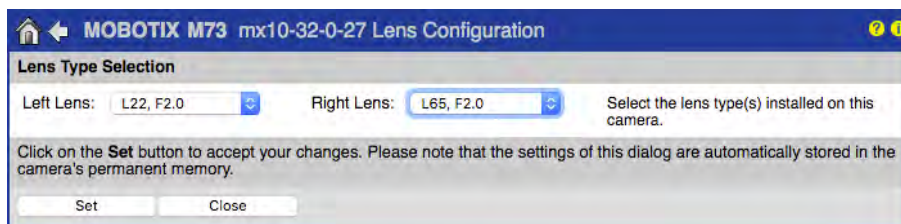

Abb. 61: Configuring the Sensor Modules

Open the Image Sensor Configuration dialog in the following cases:

- Switching the displayed camera images: You want to show the left-hand camera image on the right (and vice versa), without having to physically swap the module connectors at the camera itself.
- Exchanging sensor modules: In this case, the M73 will display a message box and will log a system message to inform you that sensor modules have been exchanged (see also [Installing the Sensor Modules, S. 54](#)).
- Adding/activating sensor modules: You can activate modules that had been deactivated before.
- Switching off/removing sensor modules: If required, you can deactivate connected modules in this dialog.

For more information, please consult the Reference Manual of the camera.