

# Front

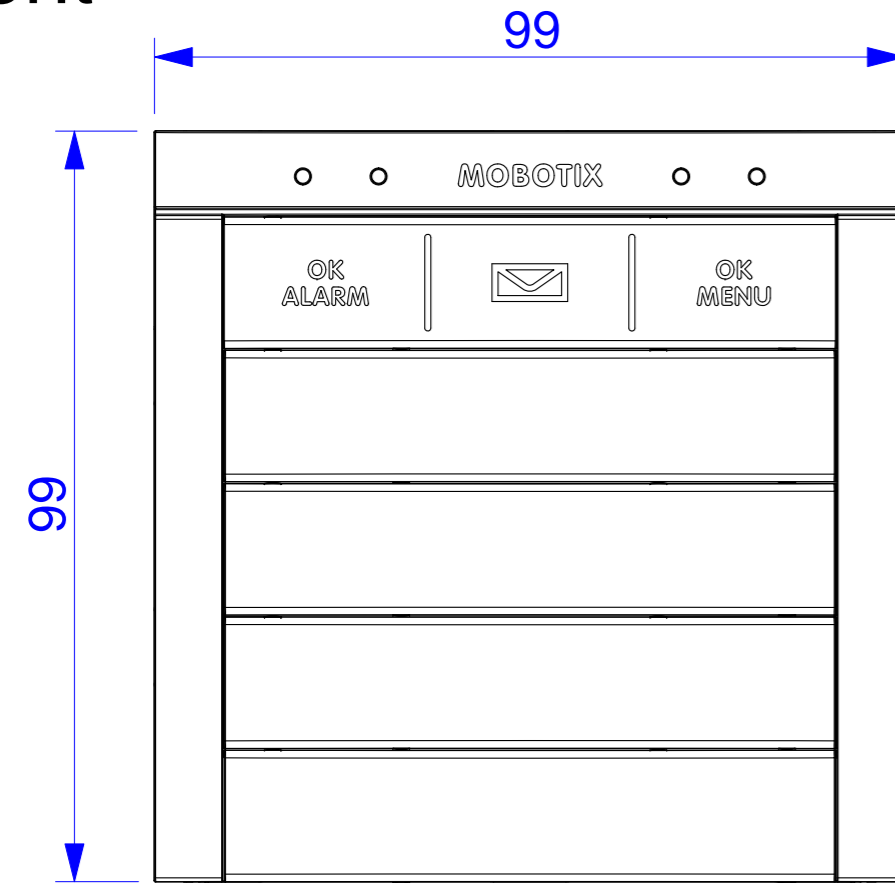

# Side

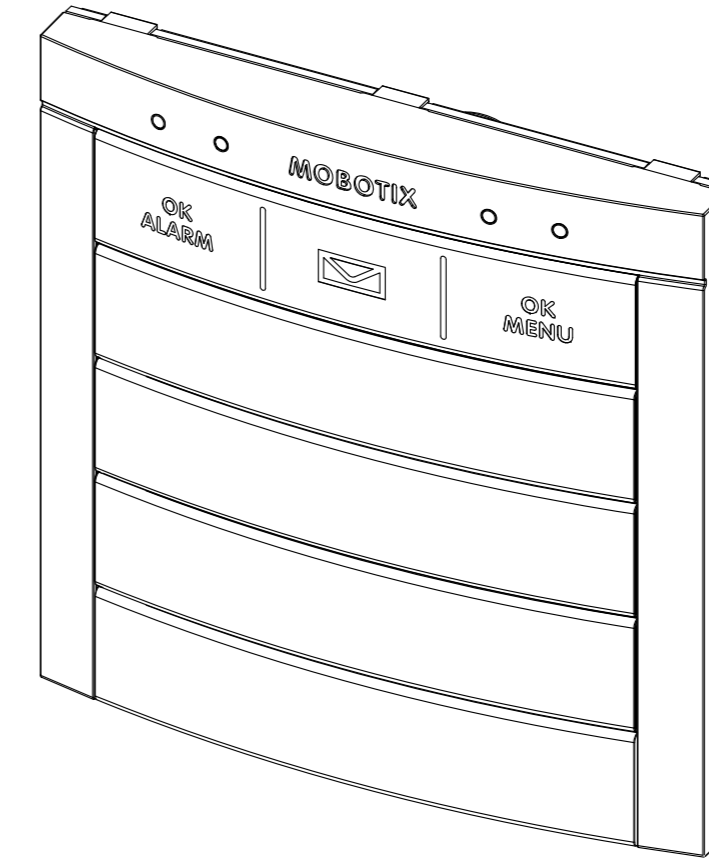
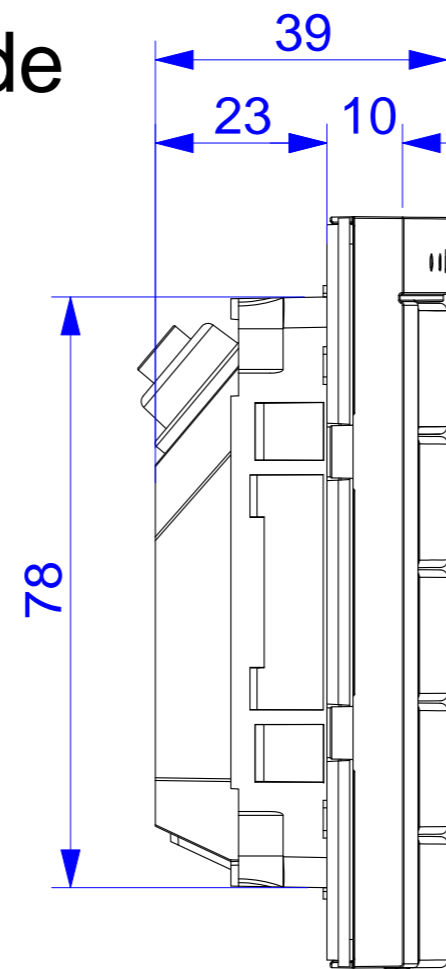

# Variants

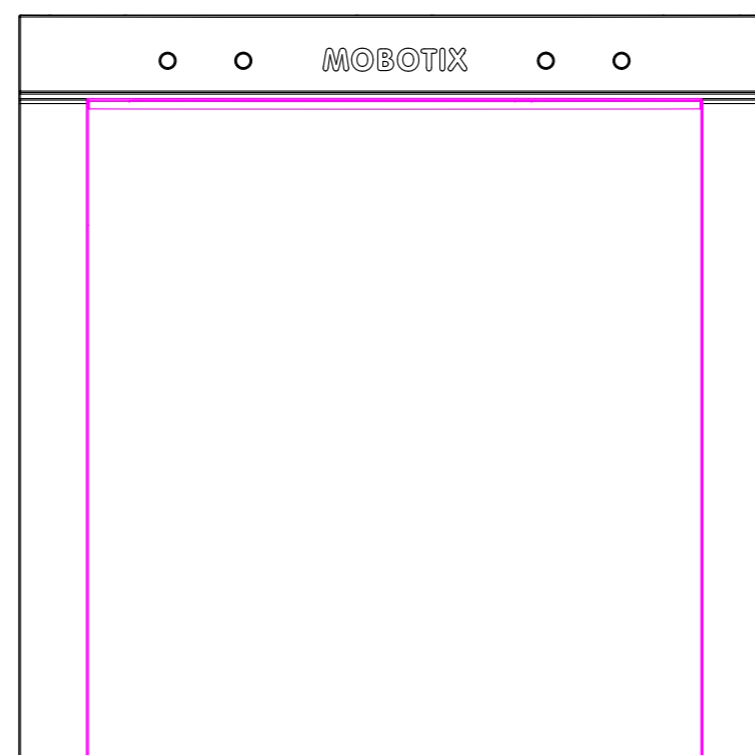
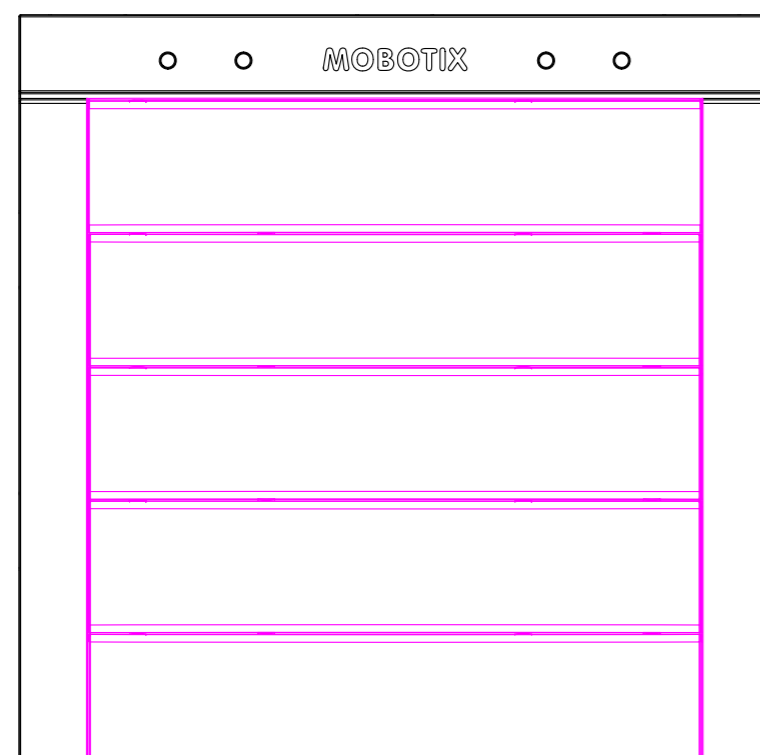
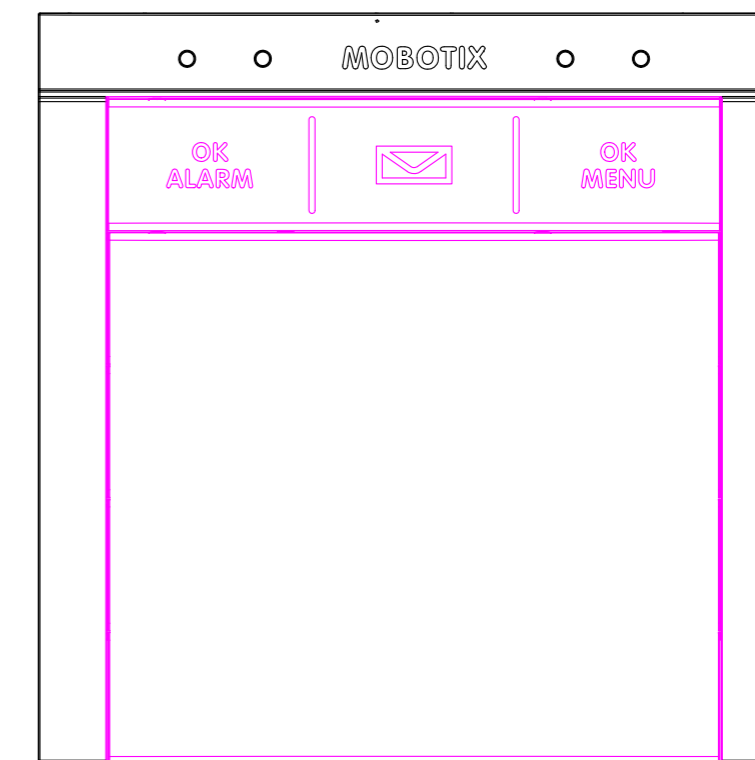
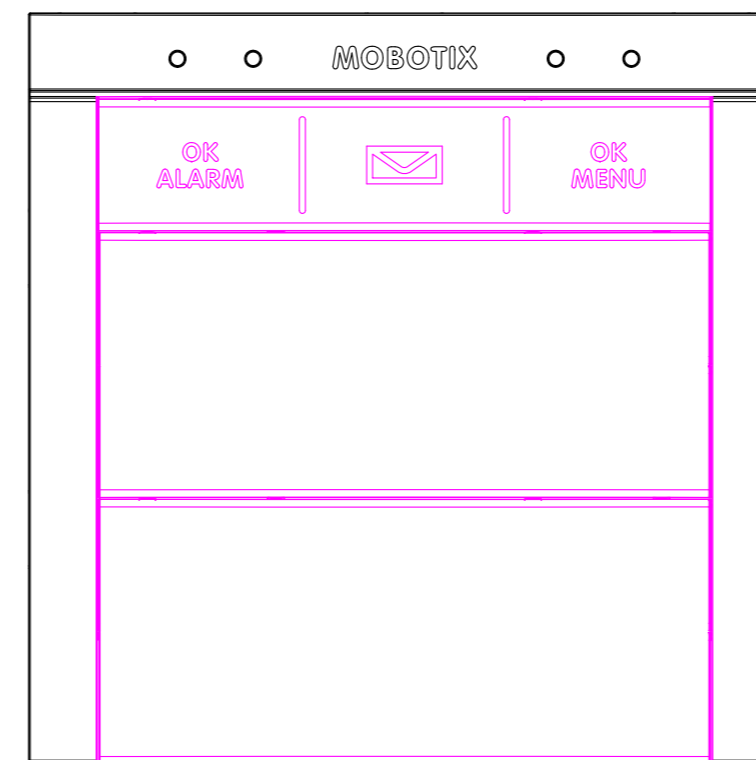
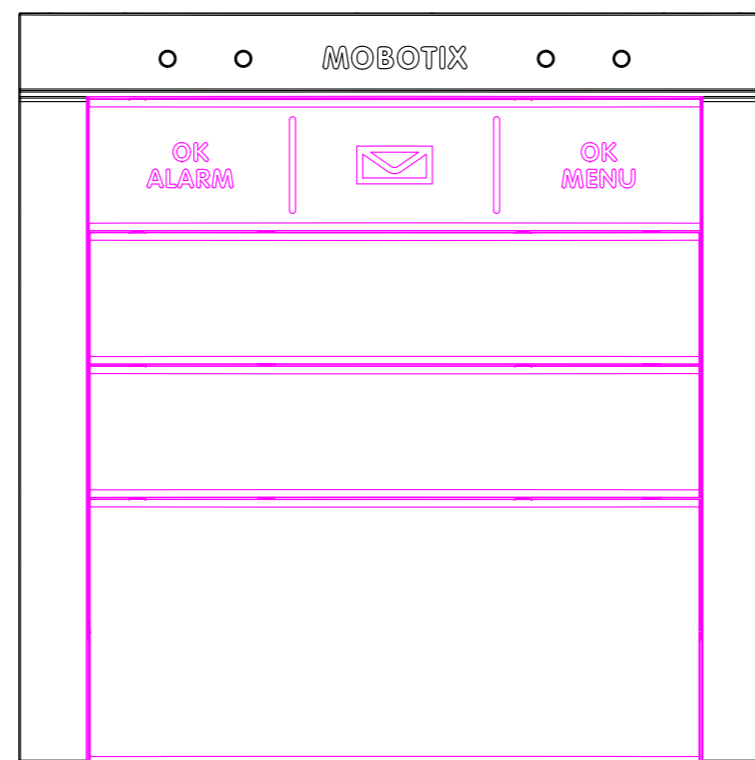
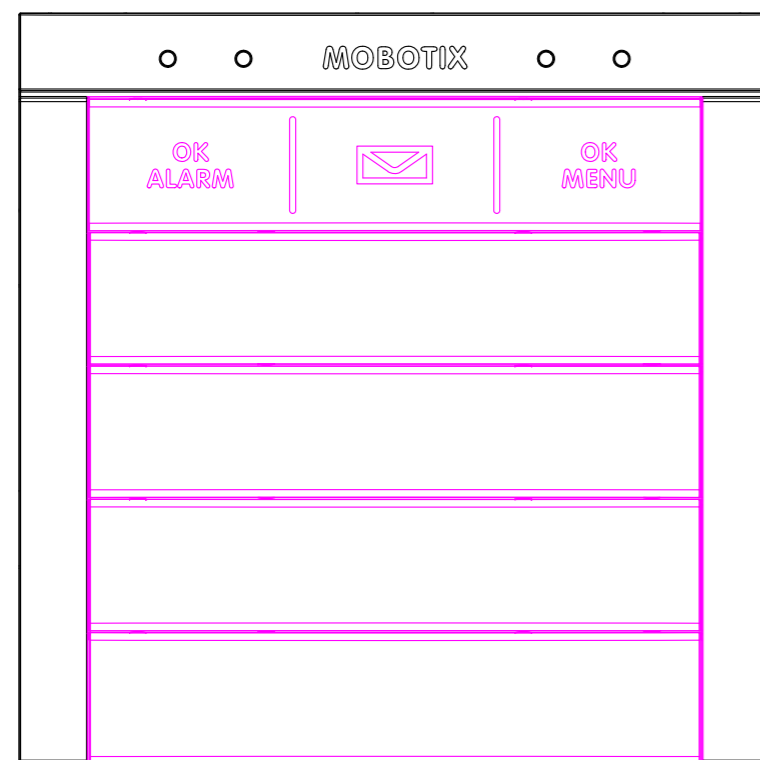

For internal use only. Technical specifications subject to change without notice. MOBOTIX does not assume responsibility for mistakes and recommends to verify measures and mechanical design with an actual product of the chosen MOBOTIX hardware. The reproduction, distribution and utilization of this document as well as the communication of its contents to others without express authorization is prohibited. Offenders will be held liable for the payment of damages. All rights reserved in the event of the grant of a patent, Utility model, design or trademark. No rights are transferred herewith.

All measures are in mm		Surface quality		Company	
				<b>MOBOTIX AG</b>	
	Name	Signature	Date	Product	
Drawn	SBe		13.07.17	<b>BellRFID Module</b>	
Tested				<b>Door Station</b>	
Approved				Drawing	
Production				DIN A2	
Quality				Scale 1:1	
				Page 1/1	
			Weight		

Front

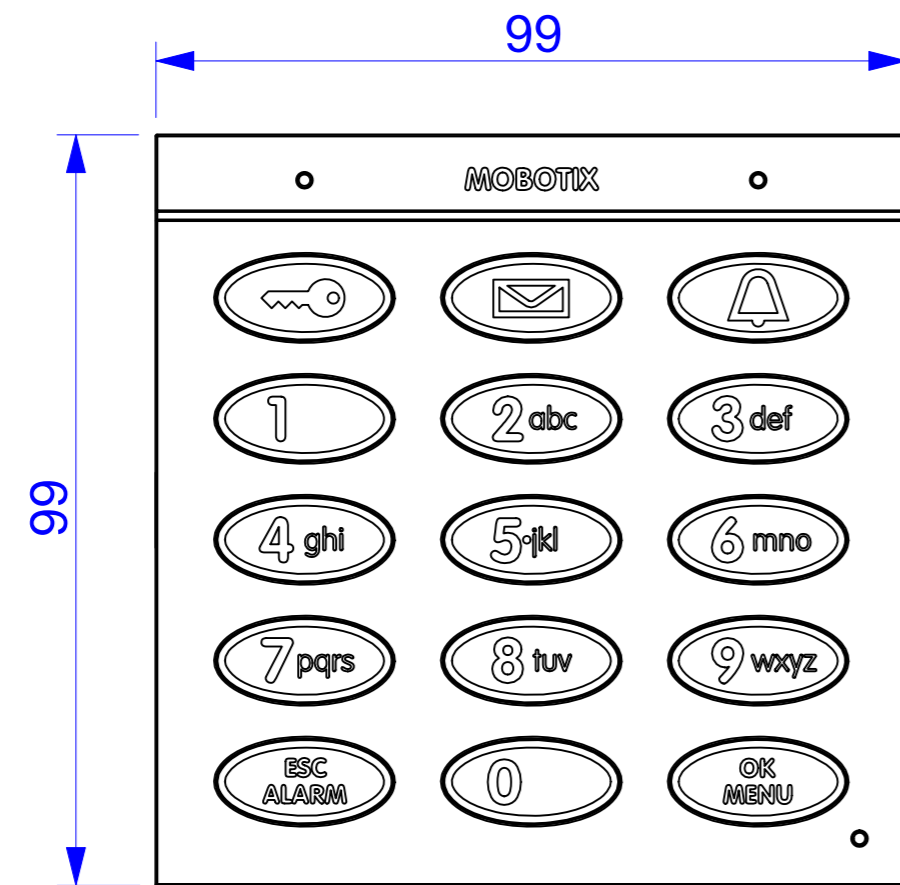

Side

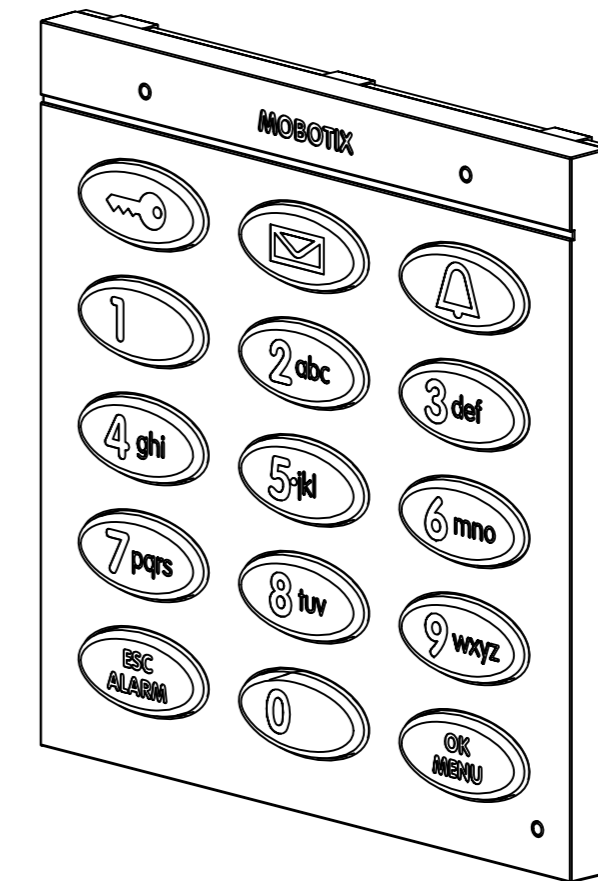
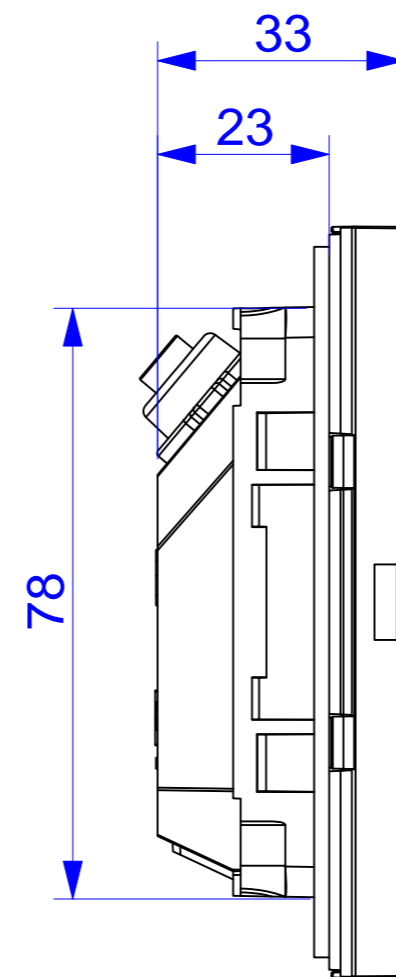

For internal use only. Technical specifications subject to change without notice. MOBOTIX does not assume responsibility for mistakes and recommends to verify measures and mechanical design with an actual product of the chosen MOBOTIX hardware. The reproduction, distribution and utilization of this document as well as the communication of its contents to others without express authorization is prohibited. Offenders will be held liable for the payment of damages. All rights reserved in the event of the grant of a patent, Utility model, design or trademark. No rights are transferred herewith.

All measures are in mm		Surface quality		Company	
				MOBOTIX AG	
	Name	Signature	Date	Product	
Drawn	SBe		13.07.17	KeypadRFID Module	
Tested				Door Station	
Approved					
Production					
Quality				Material	Drawing
					DIN A2
				Weight	Scale 1:1
					Page 1/1

Front

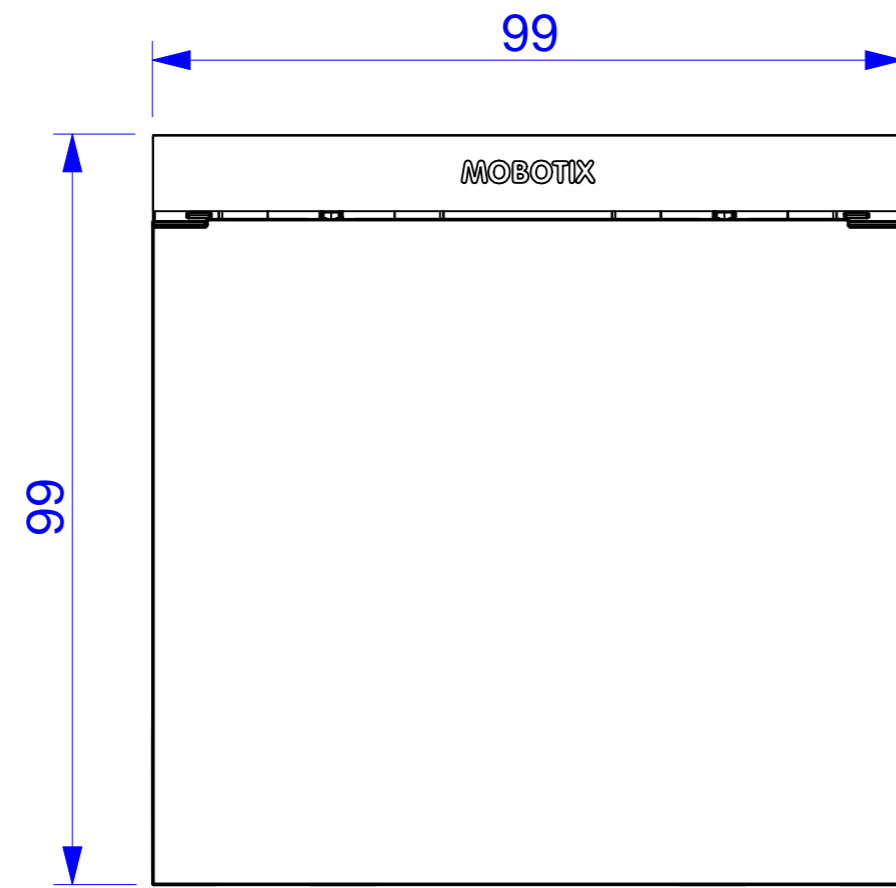

Side

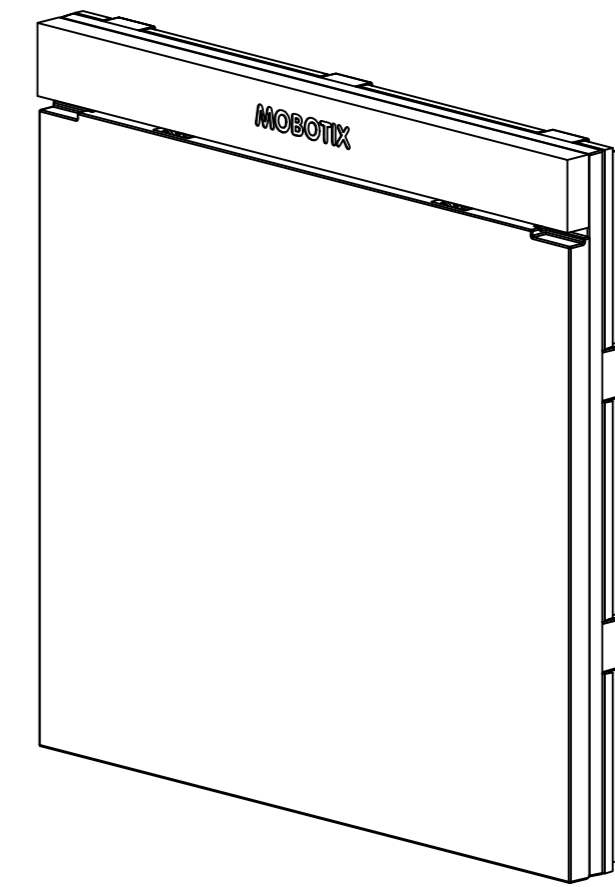
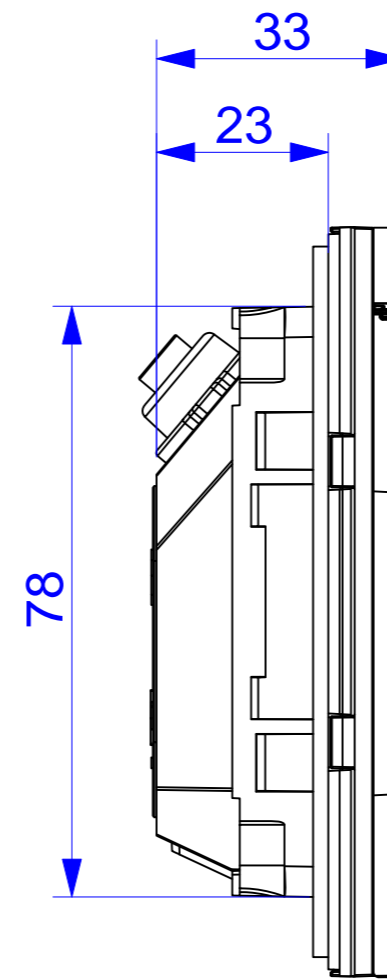

For internal use only. Technical specifications subject to change without notice. MOBOTIX does not assume responsibility for mistakes and recommends to verify measures and mechanical design with an actual product of the chosen MOBOTIX hardware. The reproduction, distribution and utilization of this document as well as the communication of its contents to others without express authorization is prohibited. Offenders will be held liable for the payment of damages. All rights reserved in the event of the grant of a patent, Utility model, design or trademark. No rights are transferred herewith.

All measures are in mm		Surface quality		Company	
				<b>MOBOTIX AG</b>	
	Name	Signature	Date	Product	
Drawn	SBe		13.07.17	<b>Info Module</b>	
Tested				<b>Door Station</b>	
Approved				Drawing	
Production				DIN A2	
Quality				Weight	
				Scale 1:1	Page 1/1