

# Quick Installation

MOBOTIX MOVE NVR-8

© 2021 MOBOTIX AG

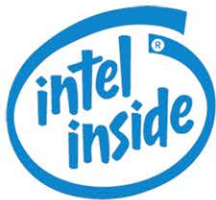

BeyondHumanVision

**MOBOTIX**

# Table of Contents

---

<b>Table of Contents</b> .....	<b>2</b>
<b>Support</b> .....	<b>4</b>
<b>Safety Warnings</b> .....	<b>5</b>
<b>Legal Notes</b> .....	<b>6</b>
<b>Installation</b> .....	<b>7</b>
Package Contents .....	7
Documentation .....	8
Front Panel .....	8
Rear Panel .....	9
Alarm I/O Connectors .....	10
HDD Installation .....	12
List of Tested Hard Disks .....	15
<b>Configuration</b> .....	<b>17</b>
Power on the NVR .....	17
Login/Logout NVR System .....	18
Power Off the NVR .....	19
Function Tabs .....	19
Language and Date / Time Setup .....	20
Language Setup .....	20
Date / Time Setup .....	20
Network Setup .....	20
IP Camera Connection .....	21
Add Device .....	21
Check IP Camera Status .....	21
Playback / Export .....	22
Local Playback by Time .....	22
Local Playback By Event .....	22
Video Export By Time .....	23
Video Export By Event .....	23

Snapshot .....	23
Snapshot Export .....	24
Playback Control Icons .....	24
Video Export Function Icons .....	24
Snapshot Function Icons .....	24
<b>Technical Specifications</b> .....	<b>25</b>
Power Consumption of MOBOTIX MOVE Cameras .....	27
List of Tested Hard Disks .....	27
<b>Imprint</b> .....	<b>29</b>

# Support

If you need technical support, please contact your MOBOTIX dealer. If your dealer cannot help you, he will contact the support channel to get an answer for you as quickly as possible.

If you have internet access, you can open the MOBOTIX help desk to find additional information and software updates. Please visit:

[www.mobotix.com](http://www.mobotix.com) > [Support](#) > [Help Desk](#)



# Safety Warnings

- This product must not be used in locations exposed to the dangers of explosion.
- Electrical systems and equipment may only be installed, modified and maintained by a qualified electrician or under the direction and supervision of a qualified electrician in accordance with the applicable electrical guidelines. Make sure to properly set up all electrical connections.
- Make sure to install this product in a well-ventilated spot and do not close off any vent openings.
- Do not use this product in a dusty environment.
- Protect this product from moisture or water entering the housing.
- Make sure that you install this product as outlined in this document. A faulty installation can damage the product!
- Do not replace batteries of the product. Batteries can explode if they are replaced by an incorrect type.
- This equipment is not suitable for use in locations where children are likely to be present.
- This equipment is to be connected only to PoE networks without routing to other networks.
- If using a Class I adapter, the power cord shall be connected to a socket-outlet with proper ground connection.
- To comply with the requirements of EN 50130-4 regarding the power supply of alarm systems for 24/7 operation, it is highly recommended to use an uninterruptible power supply (UPS) for powering the product.
- In case this product must be opened (e.g., when adding a hard drive), you must take precautions to prevent electrostatic discharge (ESD). Use an ESD wrist band or touch a grounded metallic surface before opening the device!

# Legal Notes

## Legal Aspects of Video and Sound Recording

You must comply with all data protection regulations for video and sound monitoring when using MOBOTIX AG products. Depending on national laws and the installation location of the MOVE NVR-8, the recording of video and sound data may be subject to special documentation or it may be prohibited. All users of MOBOTIX products are therefore required to familiarize themselves with all applicable regulations and to comply with these laws. MOBOTIX AG is not liable for any illegal use of its products.

## Declaration of Conformity

The products of MOBOTIX AG are certified according to the applicable regulations of the EC and other countries. You can find the declarations of conformity for the products of MOBOTIX AG on [www.mobotix.com](http://www.mobotix.com) under Support > Download Center > Certificates & Declarations of Conformity.

## RoHS Declaration

The products of MOBOTIX AG are in full compliance with European Unions Restrictions of the Use of Certain Hazardous Substances in Electrical and Electronic Equipment (RoHS Directive 2011/65/EC) as far as they are subject to these regulations (for the RoHS Declaration of MOBOTIX, please see [www.mobotix.com](http://www.mobotix.com), Support > Download Center > Documentation > Brochures & Guides > Certificates).

## Disposal

Electrical and electronic products contain many valuable materials. For this reason, we recommend that you dispose of MOBOTIX products at the end of their service life in accordance with all legal requirements and regulations (or deposit these products at a municipal collection center). MOBOTIX products must not be disposed of in household waste! If the product contains a battery, please dispose of the battery separately (the corresponding product manuals contain specific directions if the product contains a battery).

## Disclaimer

MOBOTIX AG does not assume any responsibility for damages, which are the result of improper use or failure to comply to the manuals or the applicable rules and regulations. Our General Terms and Conditions apply. You can download the current version of the **General Terms and Conditions** from our website at [www.mobotix.com](http://www.mobotix.com) by clicking on the corresponding link at the bottom of every page.

## Installation

### Package Contents

Make sure the delivered box contains the following items:

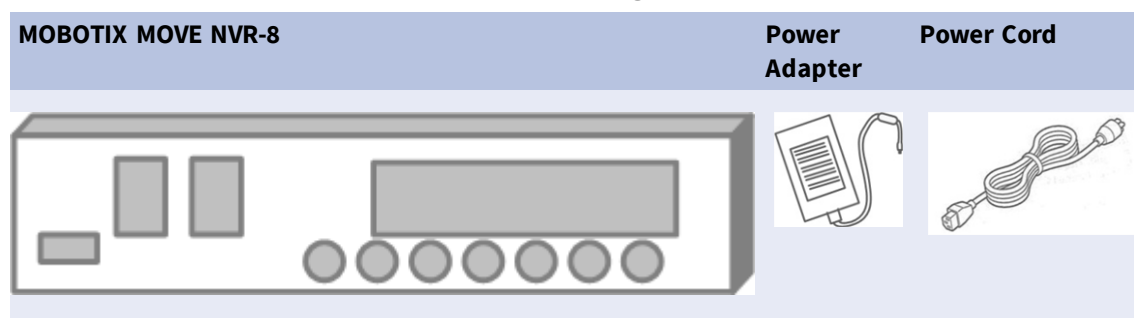

## Documentation

Scan the QR code or follow the link to find the MOBOTIX MOVE NVR-8 documentation:



[www.mobotix.com](http://www.mobotix.com) > [Support](#) > [Download Center](#) > [Marketing & Documentation](#) > [Manuals](#) > [Accessories](#) > [MOVE NVR-8](#).

## Front Panel

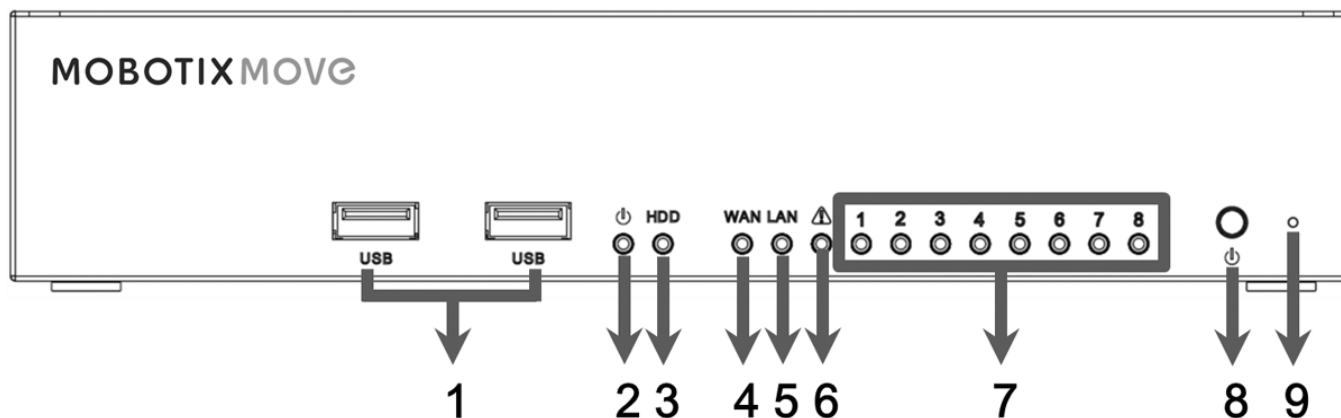

Item	Name	Description
1	USB 2.0 Port x2	The USB ports allow users to connect external USB devices, such as a USB mouse, a USB keyboard, a USB storage device, etc.
2	Power LED	This lights up when the power is on.
3	HDD LED	<ul style="list-style-type: none"> <li>Flashing: The HDD is reading/writing data.</li> <li>OFF: The HDD is not running.</li> </ul>
4	WAN LED	<ul style="list-style-type: none"> <li>Orange: Network speed is 1000 Mbps.</li> </ul>
5	LAN LED	<ul style="list-style-type: none"> <li>Green: Network speed is 10/100 Mbps.</li> </ul>
6	P. Max	This lights up as warning when there are 10 watts left to reach the power budget of PoE switch.
7	Camera LED	Lights up when the camera is powered up and has good network connection.



Item	Name	Description
		<ul style="list-style-type: none"> <li>■ Lights up in Green when the power source is from NVR.</li> <li>■ Lights up in Orange when the camera is powered by external power supply.</li> </ul>
8	Power Button	Press this button to power on the NVR system.
9	Reset Button	Press this button with a proper tool to restore the factory defaults of the NVR system.

## Rear Panel

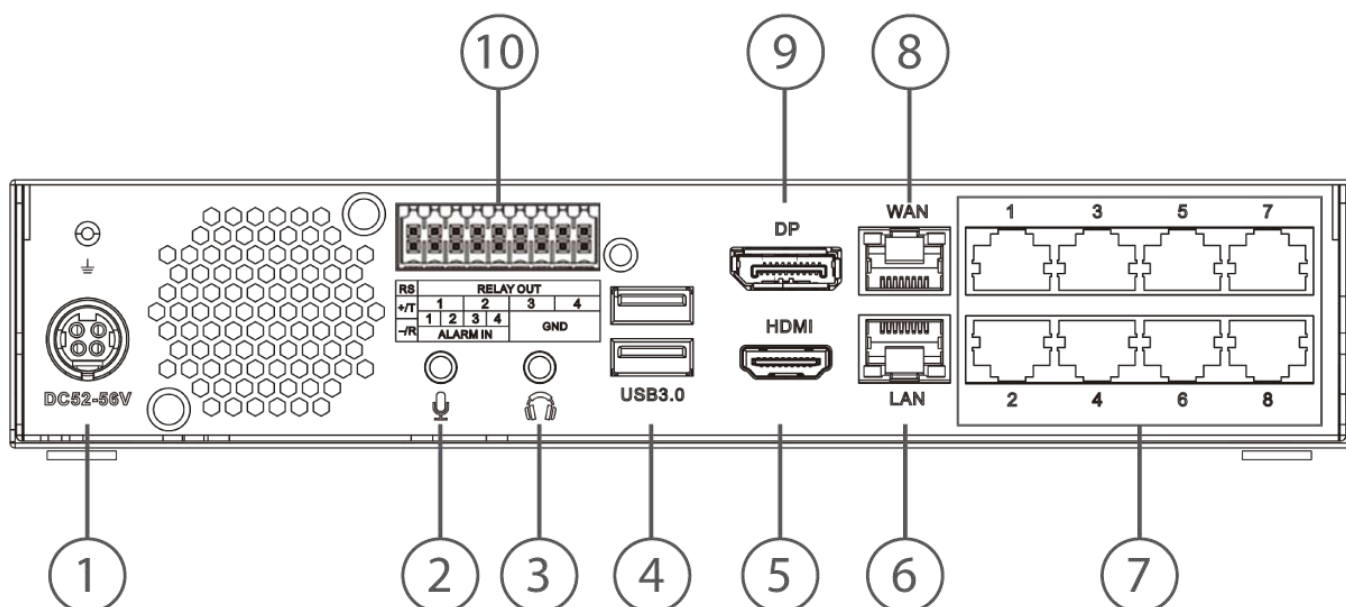

Item	Name	Description
1	Power Jack (DC 52 – 56 V)	Connect the power adapter and the power cord shipped with the NVR to power on the NVR system. Use other power supply may cause overloading.
2	Mic In	A 3.5 mm phone jack is provided to input/output audio.
3	Audio Out	
4	USB 3.0 Port x2	The USB ports allow users to connect external USB devices, such as a USB mouse, a USB keyboard, a USB storage device, etc.
5	HDMI Monitor	The video connectors are used to connect to a corresponding HDMI jack of the monitor.

## Installation

### Rear Panel

Item	Name	Description
6	LAN (RJ45) 10/100/1000 Mbps	This port can be used for connecting 4 additional IP cameras using an external PoE switch or a switch and cameras with external power supply. <ul style="list-style-type: none"><li>■ Green LED: Flashes when data is being transmitted via network.</li><li>■ Orange LED:<ul style="list-style-type: none"><li>— Lights up in green when network speed is 10/100 Mbps.</li><li>— Lights up in orange when network speed is 1000 Mbps.</li></ul></li></ul>
7	PoE Switch	The PoE switch provides network connectivity and power supply for up to 8 IP cameras.
8	WAN (RJ45) 10/100/1000 Mbps	This port is for connecting to the Internet (i.e., DSL router). <ul style="list-style-type: none"><li>■ Green LED: Flashes when data is being transmitted via network.</li><li>■ Orange LED:<ul style="list-style-type: none"><li>— Lights up in green when network speed is 10/100 Mbps.</li><li>— Lights up in orange when network speed is 1000 Mbps</li></ul></li></ul>
9	DisplayPort	The video connector is used to connect to a corresponding DisplayPort output jack of the monitor.
10	Alarm I/O Connectors	These alarm I/O connectors allow connecting other devices to the NVR. For the pin-out, see <a href="#">Alarm I/O Connectors, p. 10</a> below.  <b>NOTE</b> These connectors are available on MOVE NVR-8 devices with a serial number of RD20C00001 and higher.

## Alarm I/O Connectors

### NOTE

These connectors are available on MOVE NVR-8 devices with a serial number of RD20C00001 and higher.

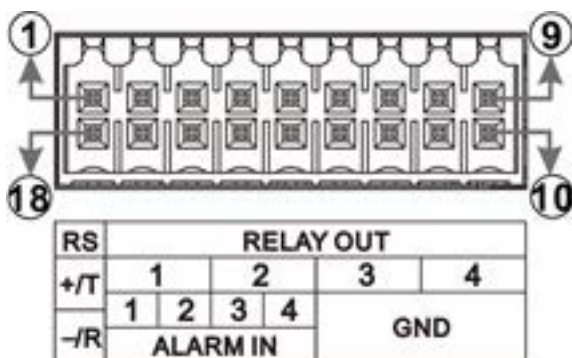

Fig. 1: Pin numbering scheme of MOVE NVR-8 alarm I/O connectors

### Pin-Out of Alarm I/O Connectors

Pin	Connector
1	RS485 D+
2	
3	Relay Out 1
4	
5	Relay Out 2
6	
7	Relay Out 3
8	
9	Relay Out 4
10	GND 1
11	GND 2
12	GND 3
13	GND 4
14	Alarm Input 4
15	Alarm Input 3
16	Alarm Input 2
17	Alarm Input 1
18	RS485 D-

# HDD Installation

## Warning

- Switch off the device and disconnect the power plug!
- Take precautions to prevent electrostatic discharge (ESD). Use an ESD wrist band or touch a grounded metallic surface before opening the device!

1. Open the housing of the MOBOTIX MOVE NVR-8.
  - Loosen the screws on each side of the housing.



- Loosen two screws on the bottom side.

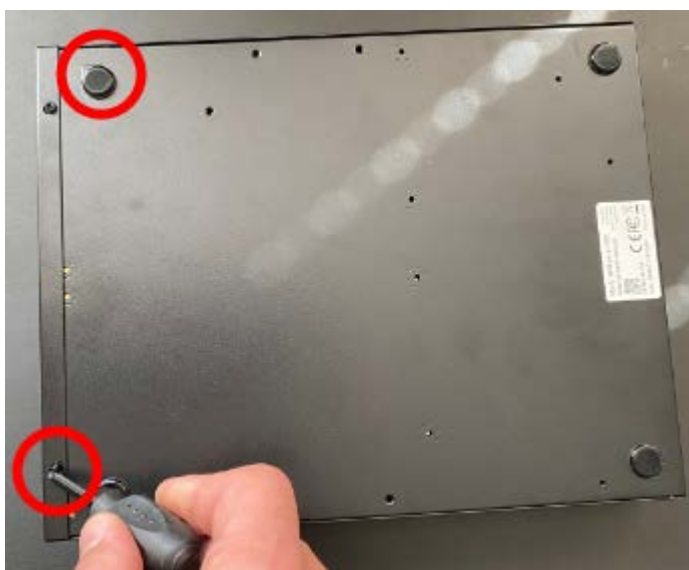

- Loosen one screw on the upper side.

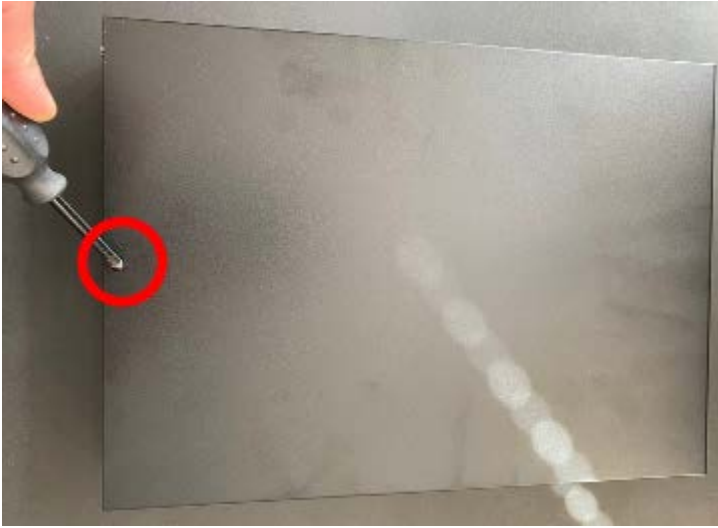

2. Remove the HDD rack.

- Loosen four screws per hard disk.

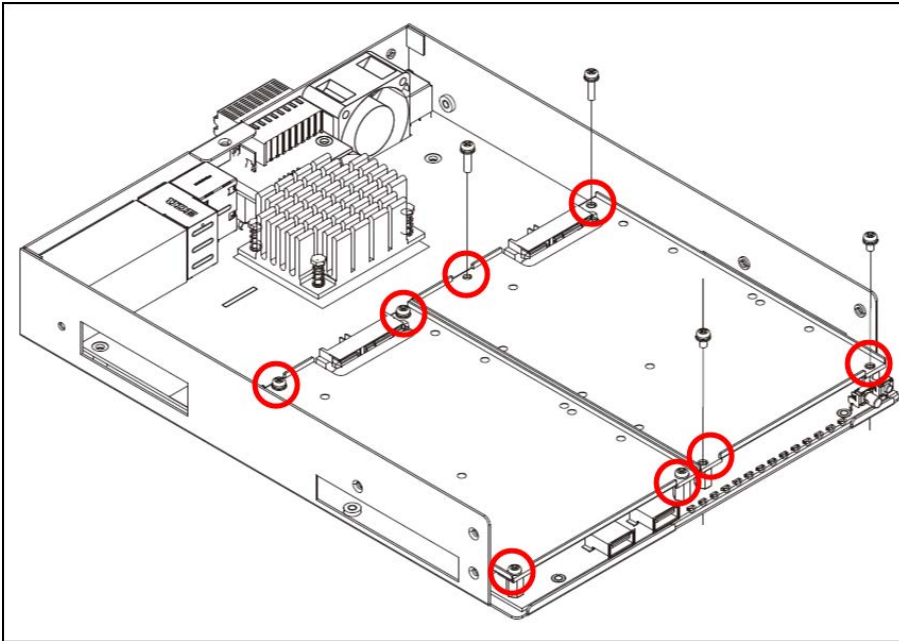

3. Mount the HDD onto the rack.

## Installation

### HDD Installation

- Fasten four screws per hard disk. Screws are included with the hard disk.

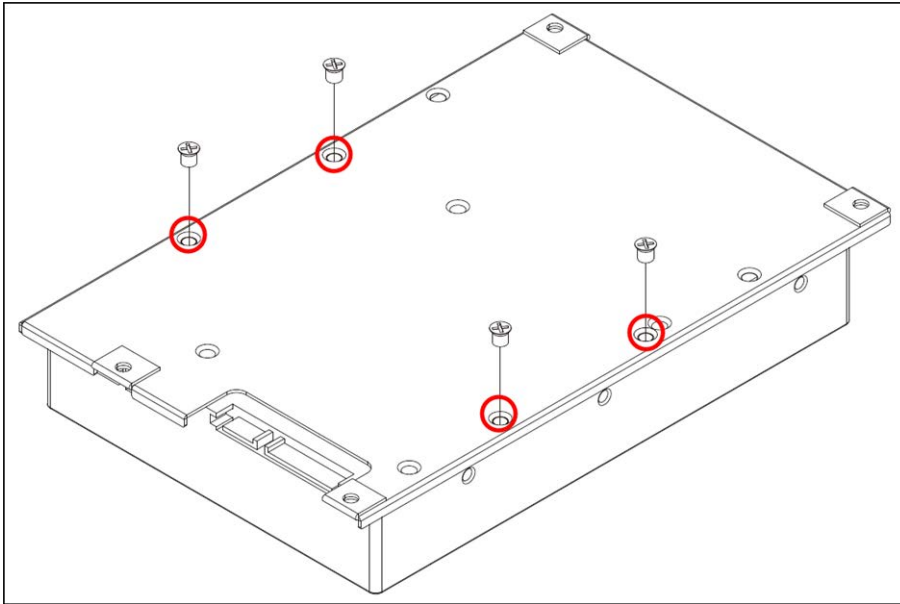

4. Mount the HDD rack back to its original position.
  - Carefully push the hard disk frame(s) into the socket and then re-fasten the hard disk frame with four screws.

#### Note

No SATA cable required; the HDD is connected automatically.



5. Close the housing.
  - Fasten the screws you removed step 1 in reverse order.

## List of Tested Hard Disks

**Note:**

To ensure long-term reliable operation, make sure that you are using **server-grade hard disks** from the manufacturers' series listed below.

Brand	Series	Model Number	Firmware	Capacity
Seagate	Skyhawk	ST8000VX004	AV01	8 TB
		ST14000VX008		14 TB
Western Digital	Purple	WD82PURZ	82.00A82	8 TB
		WD140PURZ		14 TB





## Configuration

### Power on the NVR

**Note**

Although you could use a browser for initial setup of the MOVE NVR-8, it is highly recommended to use a monitor and a USB keyboard (mouse is optional) for this first step.

1. Before powering on the NVR, connect the necessary devices first:
  - USB Mouse & USB Keyboard
  - Internet (WAN)
  - Monitor (HDMI and/or DisplayPort)
  - IP cameras via PoE ports
2. Be sure to check the type of power source before plugging the power cord and power adapter to the NVR.
3. Press the Power Key on the front panel to power up the NVR system.

#### Note

If you want to use temporary USB storage media, make sure those devices are connected only **after** the NVR has been powered on.

#### Note

When using a browser to access this product, it is recommended to use Internet Explorer 10 or higher with ActiveX support to achieve the best performance.

## Login/Logout NVR System

Two accounts are predefined on the MOBOTIX MOVE NVR-8: “Guest” and “Admin”. The password for both users is “meinsm”.

## Login

#### Warning

Always change the preset password of the “Guest” user to prevent unauthorized access to the unit.

Once the NVR is powered on, a popup window will appear:

- Click on OK to continue as user “Guest”.
- Click on **Setup** and change the default password “meinsm”. To show the virtual keyboard, click twice in the password field.

#### Note

- Password length is 6 to 12 characters.
- These characters are allowed: A-Z, a-z, 0-9, !#\$%&'-.@^\_~

You are now logged in as Guest user. Proceed by changing the “Admin” user password as shown below:

1. Move the mouse cursor to the top-right corner of the monitor, click **Guest** and select **LogOut** to open the login window.
2. Select the administrator account “Admin”.
3. Enter the password “meinsm”. To show the virtual keyboard, click twice in the password field.
4. Press **Enter** on the keyboard or click **Confirm** in the login window to log into the NVR system as administrator.

## Change the Admin User Password

#### Warning

Always change the preset password of the “Admin” user to prevent unauthorized access to the unit.

- Log in as “Admin” user.
- Click on **Setup > User Management > Edit**.
- Click on **Setup** and change the default password “meinsm”. To show the virtual keyboard, click twice in the password field.



**Note**

- Password length is 6 to 12 characters.
- These characters are allowed: A-Z, a-z, 0-9, !#\$%&'-.@^\_~

## Logout

To log out, click on the username and select **LogOut**.

## Power Off the NVR

1. Click Power icon  at the top-right corner of the monitor, and the Power Panel will show up.
2. Click Power Off icon , and the NVR system will start the shutdown procedure.
3. Otherwise, click Cancel icon  to abort.

**Note**

Do not remove the power source until the NVR is completely off.

## Function Tabs

There are six function tabs including **Live View**, **Playback / Export**, **Add Device**, **Record**, **Setup** and **Log**.

- **Live View:** This function tab allows users to watch the live view of the connected IP devices and configure camera settings, such as PTZ control, image setup, video format, motion detection setup, etc.
- **Playback / Export:** Users can playback / export the recorded videos filtered by time / event and review / export the saved snapshots.
- **Add Device:** Users can search and add the IP devices to the NVR via network and through PoE ports.
- **Record:** The Record function tab allows users to arrange recording schedule, configure circular recording, and setup alarm behavior configuration.
- **Setup:** Under Setup function tab, users can setup the basic NVR settings, such as language, factory default, date / time setup, network setup, storage setup, user account management, etc.

- **Log:** The NVR divides the log data into four categories, User Operation Log, IP Camera Event, VA Detected Event and PoE Switch Event. Users can view, search and export the log data under this function tab.



## Language and Date / Time Setup

### Language Setup

1. Under Setup function tab, select **Language** to enter the language setting menu.
2. Select the preferred language from the language drop-down list and click **Apply** to save the setting.
3. Otherwise, click **Cancel** to cancel the setting.

### Date / Time Setup

The Date / Time setting menu can be found under this path: **Setup > System > Date / Time**.

1. To set a date, select the correct date from the calendar and click **Apply** to save the setting.
2. To set up time, click on the target position in the time field (hour:minute:second AM/PM).
3. Click buttons  or  or scroll the mouse wheel up / down to adjust the time values.
4. Click **Apply** to save the setting.

## Network Setup

Configure the network setup for the NVR to properly function with Ethernet connection. The Network setting menu can be found in this path: **Setup > Network**.

- **Interface:** Users can setup WAN and LAN configuration under this setting menu. Select "eth0 (WAN)" to enter WAN configuration menu, and select "eth3 (LAN)" to setup the LAN settings.
  - **DHCP Setup:** In the WAN configuration menu, the DHCP function allows users to obtain a dynamic IP address from DHCP (Dynamic Host Configuration Protocol) server when the NVR boots up.
1. For DHCP users, check "Enable DHCP" box and click **Restart**. The IP address, Subnet Mask, Gateway and DNS settings listed in IPv4 will be retrieved from network servers. DHCP is dynamic that the settings change from time to time.

2. For non-DHCP users, uncheck “Enable DHCP” box, and fill out the required values listed in IPv4 by clicking on the box next to each item and using the displayed number pad or the USB keyboard. Please obtain the information from the network service provider.
3. Click **Apply** to save the setting.

**Note**

For more details regarding LAN configuration, please refer to User’s Manual.

## IP Camera Connection

Users can connect the IP cameras to the NVR via the network connection or through the PoE ports on the rear panel.

Follow the instructions below to connect IP cameras to the NVR.

### Add Device

1. Enter Add Device function tab.
2. Select the preferred device type, e.g. MOVE H.264, MOVE H.265, ONVIF, etc., from the **Device Filter** drop-down list.
3. Click Re-scan Device icon , and the NVR will start to search and list the connected devices meeting the searching criteria.
4. Check “Device add to view” box in front of the desired IP device(s) to add it to the NVR.

**Note**

For more details regarding IP Camera connection and camera setup, refer to User’s Manual.

### Check IP Camera Status

In the Live View function tab, the camera title bar is above each channel grid. The IP camera connection status can be examined by the color of the title bar.

Title Bar Color	IP Camera Status
Grey	Not connected
Green	Connecting
Blue	In good connection
Red	Failed connection

## Playback / Export

The NVR is capable of playing back the recorded videos by time / event and exporting the recorded videos and snapshots under Playback / Export function tab.

Follow the instructions below to operate the functions.

### Local Playback by Time



1. Select any underlined date from the calendar, which indicates the recording data are available from these dates. The yellow stripe(s) in the time bar at the bottom of the function tab indicates available recorded videos for users to playback.
2. Then, click and drag the time bar below to assign a preferred time from the time bar. Move the mouse cursor to the time bar and scroll up/down the mouse wheel to adjust the time scale to select the exact desired time. The selected time will be displayed above the time bar.
3. Click Playback icon  to start playing back the recorded videos.

### Local Playback By Event

1. In the Event Search Filter, check “Search By Time” box and specify the Start and End time of the desired time interval. Check “Search By Channel” box to select the desired channel. Check “Search By Type” box to select the preferred event type including Motion, Video Loss or Alarm.
2. Click **Search** and the event videos, which meet the searching criteria will be listed next to the Event Search Filter.
3. The Event List displays events by date/time, event type, and triggered camera channel in chronological order.
4. Click on any event; the NVR will automatically start playing back the selected event video.

## Video Export By Time

Before starting the video export, make sure an external USB storage device is installed.



1. Click and drag the Time Interval icon  to the time bar to select the desired time interval of the recorded video.
2. Adjust the preferred time segment by dragging the Time Range Adjustment icon .
3. Click **Start Export**. An Export window will be displayed.
4. Check the desired channel(s) and the exportation data including data size will be shown.
5. Select the preferred video format.
6. Click **Confirm** in the Export window to start the video export.
7. Otherwise, click **Cancel** to abort.

## Video Export By Event

Before starting the video export, make sure an external USB storage device is installed.

1. Choose the preferred event video from the Event List.
2. Click **Start Export**. An Export window will be displayed.
3. The exportation data including data size will be shown.
4. Select the preferred video format.
5. Click **Confirm** in the Export window to start the video export.
6. Otherwise, click **Cancel** to abort.

## Snapshot









1. Click **Snapshot** setting menu and select the preferred snapshot from the Snapshot List to check its preview.
2. The information of the selected file, including the file created date/time, image resolution and image size, will be displayed next to the snapshot viewing window.
3. Check the preferred file(s) to be deleted and then click Delete icon  to remove the selected file(s) from the Snapshot List.
4. Otherwise, click Select All icon  to choose all the files at once.

## Snapshot Export







Before starting the snapshot export, make sure an external USB storage device is installed.

1. Select the desired snapshot(s) from the Snapshot List.
2. Click Export icon , and an Export window will be displayed.
3. Click **Confirm** to start exporting the file(s); otherwise, click **Cancel** to abort.



## Playback Control Icons

Icon	Description	Icon	Description	Icon	Description
	Forward Playback		Pause Playback		Backward Playback
	Playback Speed x 1/4		Playback Speed x 1/2		Playback Speed x 1
	Playback Speed x 2		Playback Speed x 4		

## Video Export Function Icons

Icon	Description	Icon	Description
	Time Interval Pin		Time Range Adjustment
	Clear Tag		Start Export Video
	Data Erase / Protect		Instruction of Time Bar Adjustment

## Snapshot Function Icons

Icon	Description	Icon	Description
	Delete Snapshot		Export Snapshot
	Select All Snapshots		



## Technical Specifications

Type	Mx-S-NVR1A-8-POE
<b>System</b>	
Operating System	Embedded Linux
CPU	Intel Apollo Lake E3930
RAM	LPDDR4, 2 x 1 GB
Boot Drive	eMMC Flash, 16 GB
Graphics	Intel HD Graphics 500
DisplayPort Output	1920x1080@60Hz (Full HD)
HDMI Output	1920x1080@60Hz (Full HD)
Audio Input	MIC-in, 3.5 mm x1 earphone
Audio Output	Line-out, 3.5 mm x1 earphone
USB Ports	USB 2.0 x2 (front); USB 3.0 x2 (rear)
<b>Recording / Playback</b>	
IPCAM Throughput	Average: 80 Mbps; Peak: 120 Mbps

## Technical Specifications

---

Type	Mx-S-NVR1A-8-POE
GPU Hardware Decoding	12 CH real-time display, up to 360 fps@D1 decoding
Compression Format	H.264 / H.265
Browser support	Internet Explorer 10 or higher with ActiveX recommended for best performance
<b>Storage</b>	
Build-in SATA Interface	3.5" SATA3 x2
Max. HDD storage support (internal & ext. iSCSI)	20 TB
<b>Onboard Hardware Interfaces</b>	
M.2 (M-Key)	Yes
Alarm I/O Connectors	4 relay outputs, 4 signal inputs, 1 RS485 D+, 1 RS485 D- ports (pin-out see <a href="#">Alarm I/O Connectors, p. 10</a> )
	<b>NOTE</b> These connectors are available on MOVE NVR-8 devices with a serial number of RD20C00001 and higher.
<b>Network</b>	
WAN Uplink	RJ45 x1, 10/100/1000 Mbps
LAN Uplink	RJ45 x1, 10/100/1000 Mbps
LAN ports with PoE	RJ45 x8, 10/100 Mbps
Total number of supported cameras	12 (8 on internal LAN ports with PoE, plus 4 using external PoE switch attached to LAN port)
PoE Level	IEEE 802.3 af/at x8
PoE & switch management	Linux SDK
Supported protocols	User Authentication, IEEE 802.1x, IPv4, TCP, UDP, DHCP, SMTP, RTP, RTSP, HTTP, NTP, DDNS, iSCSI
<b>General</b>	
Unit Dimensions (mm)	220 x 275 x 44
Unit Weight (kg)	1.4
Package Dimensions (mm)	426 x 379 x 110
Package Weight (kg)	4.2

<b>Type</b>	<b>Mx-S-NVR1A-8-POE</b>
Operating Temperature	0 to 40 °C/32 to 104 °F
Operating Relative Humidity	10 to 90 % non-condensing
System Power Supply	AC 100 to 240 V
PoE Budget per Port	30 W
Total PoE Budget	120 W

## Power Consumption of MOBOTIX MOVE Cameras

Model	Order Code	Max. Power Consumption
BulletCamera 2MP	Mx-BC1A-2-IR...	5.6 W
BulletCamera 4MP	Mx-BC1A-4-IR...	13.68 W
VandalBullet Analytics 2MP	Mx-VB2A-2-IR-VA	13 W
VandalBullet Analytics 5MP	Mx-VB1A-5-IR-VA	13 W
SpeedDome	Mx-SD1A-330	25.4 W
SpeedDome IR	Mx-SD1A-340-IR	44 W (external PoE injector required)
VandalDome 2MP	Mx-VD1A-2-IR...	12.25 W
VandalDome 4MP	Mx-VD1A-4-IR...	13.68 W
VandalDome Analytics 2MP	Mx-VD2A-2-IR-VA	13 W
VandalDome Analytics 5MP	Mx-VD1A-5-IR-VA	13 W

## List of Tested Hard Disks

**Note:**

To ensure long-term reliable operation, make sure that you are using **server-grade hard disks** from the manufacturers' series listed below.

## Technical Specifications

### List of Tested Hard Disks

---

Brand	Series	Model Number	Firmware	Capacity
Seagate	Skyhawk	ST8000VX004	AV01	8 TB
		ST14000VX008		14 TB
Western Digital	Purple	WD82PURZ	82.00A82	8 TB
		WD140PURZ		14 TB

---

# Imprint

This document is part of the product MOVE NVR-8 distributed by MOBOTIX AG. The document describes how to use and to configure the product and its components.

Subject to change without notice.

## Copyright Information

This document is protected by copyright. Passing on information to others is not permitted without the prior written consent of MOBOTIX AG. Violations will be subject to criminal punishment.

## Patent and Copy Protection

All rights reserved. Trademarks or registered trademarks belong to the corresponding owners.

## Address

MOBOTIX AG

Kaiserstrasse

67722 Langmeil

Germany

Phone: +49 6302 9816-103

E-Mail: [sales@mobotix.com](mailto:sales@mobotix.com)

Internet: [www.mobotix.com](http://www.mobotix.com)