



Guideline

MOBOTIX FF Group License Plate Recognition App - Region EUCA

© 2021 MOBOTIX AG



Table of Contents

Table of Contents	2
Support	3
Legal Notes	4
About FF Group License Plate Recognition App - Region EUCA	5
Technical Specifications	6
Licensing Certified Apps	8
Managing Licenses in MxManagementCenter	8
Camera, image and scene requirements	15
Recommendations on mounting and adjusting.	18
Troubleshooting	19
Activation of the Certified App Interface	23
Configuration of FF Group License Plate Recognition App - Region EUCA	24
About MxMessageSystem	30
What is MxMessageSystem?	30
Facts about MxMessages	30
Basic configuration: Processing the automatically generated app events	31
Advanced Configuration: Processing the meta data transmitted by apps	35
Meta data transferred within the MxMessageSystem	35
Creating a Custom Message Event	36
Examples for message names and filter values of the FF Group License Plate Recognition App - Region EUCA	37

Support

If you need technical support, please contact your MOBOTIX dealer. If your dealer cannot help you, he will contact the support channel to get an answer for you as quickly as possible.

If you have internet access, you can open the MOBOTIX help desk to find additional information and software updates. Please visit:

www.mobotix.com > [Support](#) > [Help Desk](#)



Legal Notes

Legal Aspects of Video and Sound Recording

You must comply with all data protection regulations for video and sound monitoring when using MOBOTIX AG products. Depending on national laws and the installation location of the FF Group License Plate Recognition App - Region EUCA, the recording of video and sound data may be subject to special documentation or it may be prohibited. All users of MOBOTIX products are therefore required to familiarize themselves with all applicable regulations and to comply with these laws. MOBOTIX AG is not liable for any illegal use of its products.

Declaration of Conformity

The products of MOBOTIX AG are certified according to the applicable regulations of the EC and other countries. You can find the declarations of conformity for the products of MOBOTIX AG on www.mobotix.com under Support > Download Center > Certificates & Declarations of Conformity.

RoHS Declaration

The products of MOBOTIX AG are in full compliance with European Unions Restrictions of the Use of Certain Hazardous Substances in Electrical and Electronic Equipment (RoHS Directive 2011/65/EC) as far as they are subject to these regulations (for the RoHS Declaration of MOBOTIX, please see www.mobotix.com, Support > Download Center > Documentation > Brochures & Guides > Certificates).

Disposal

Electrical and electronic products contain many valuable materials. For this reason, we recommend that you dispose of MOBOTIX products at the end of their service life in accordance with all legal requirements and regulations (or deposit these products at a municipal collection center). MOBOTIX products must not be disposed of in household waste! If the product contains a battery, please dispose of the battery separately (the corresponding product manuals contain specific directions if the product contains a battery).

Disclaimer

MOBOTIX AG does not assume any responsibility for damages, which are the result of improper use or failure to comply to the manuals or the applicable rules and regulations. Our General Terms and Conditions apply. You can download the current version of the **General Terms and Conditions** from our website at www.mobotix.com by clicking on the corresponding link at the bottom of every page.

About FF Group License Plate Recognition App - Region EUCA

Certified App for License Plate Recognition

The app's artificial intelligence-based algorithms, which have already been successfully tested in numerous European markets, allow the reliable recognition of single and two-line license plates of vehicles in the supported regions of origin (Latin and Hebrew characters and numbers). The app can be tested free of charge for 30 days and is activated by license for an unlimited period of time. Typical application areas for the app are: Parking management, access control and regulation, traffic monitoring.

- App delivers events via MxMessageSystem in real-time
- Integrated recognition protocol (last 1000 recognized license plates)
- Detection with at least 95 % accuracy (depending on environmental conditions)
- Camera can be online or offline
- Configuration of the application also via MxManagementCenter (free Advanced Config license required)
- Can be used with all cameras of the MOBOTIX 7 system platform

Smart Data Interface

This app has a Smart Data interface to MxManagementCenter. For information on how to configure, see the corresponding online help of the camera software and MxManagementCenter.

Caution

Thermal sensors are not supported by this app.

Technical Specifications

Product Information

Product Name	FF Group License Plate Recognition App - Region EUCA
Order Code	Mx-APP-FF-LPR-EUCA
Supported MOBOTIX Cameras	Mx-M73A, Mx-S74A
Minimum Camera Firmware	V7.0.4.x
MxManagementCenter Integration	min. MxMC v2.3.1

Product Features

App Features	<ul style="list-style-type: none">- License plate recognition of one- and two-line license plates- Latin and Hebrew characters- Recognition log (last 1000 recognized license plates)- MOBOTIX events via MxMessageSystem- Extended country coverage*- White- and blacklisting
Maximum number of lanes	3
Meta Data / Statistic formats	JSON, CSV
Trial License	30-day trial license pre-installed
MxMessageSystem supported	Yes
Interfaces	MxMC Smart Data, IP Notification
MOBOTIX Events	Yes
ONVIF Events	*
Smart Data Interface to MxManagementCenter	Yes

Supported Regions

Europe	Albania, Armenia, Austria, Azerbaijan, Belarus, Belgium, Bosnia and Herzegovina, Bulgaria, Croatia, Cyprus, Czech Republic, Denmark, Estonia, Finland, France, Georgia, Germany, Greece, Hungary, Iceland, Italy, Ireland, Israel, Kazakhstan, Kirgizstan, Latvia, Lithuania, Luxembourg, Macedonia, Malta, Moldova, Montenegro, Netherlands, Norway, Poland, Portugal, Romania, Russia, Serbia, Slovakia, Slovenia, Spain, Sweden, Switzerland, Tajikistan, Turkey, Turkmenistan, Ukraine, United Kingdom, Uzbekistan, Vatican City State
Israel / Palestine	Israel / Palestine
APAC	Australia, New Zealand

Scene Requirements

Minimum License Plate Width	130 px
Maximum Vertical Angle	30°
Maximum Horizontal Angle	30°
Maximum Tilt Angle	5°
MOBOTIX App support	Yes

Technical App Specifications

Synchronous / Asynchronous App	Asynchronous
Accuracy	Min. 95% (considering scene requirements)
Processed number of frames per second	Typ. 10 fps
Detection time	Typ. 100 – 120 ms

* available with updates in future

Licensing Certified Apps

The following licenses are available for the FF Group License Plate Recognition App - Region EUCA:

- **30-day test license** pre-installed
- **permanent commercial license**

The usage period begins with activation of the app (see [Activation of the Certified App Interface, p. 23](#)).

Note

For buying or renewing a license please contact your MOBOTIX Partner.

Note

Apps are usually pre-installed with the firmware. In rare cases, apps must be downloaded from the website and installed. In this case see www.mobotix.com > [Support](#) > [Download Center](#) > [Marketing & Documentation](#), download and install the app.

Managing Licenses in MxManagementCenter

After a test period commercial licenses must be activated for use with a valid license key.

Activation of Certified Apps and events

Online-Activation

After receiving the activation IDs, activate them in MxMC as follows:

1. Select from the menu **Window > Camera App Licenses**.
2. Select the camera on which you want to license apps and click **Select**.

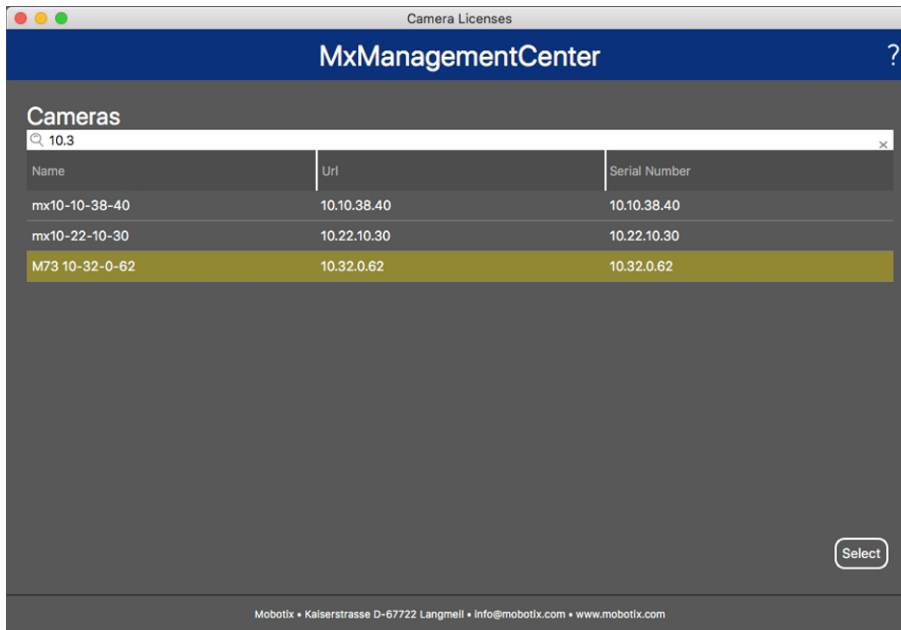

Fig. 1: Overview of Camera App Licenses in MxManagementCenter

Note

If necessary, correct the time set on the camera.

1. An overview of the licenses installed on the camera may be displayed. Click **Activate License**.

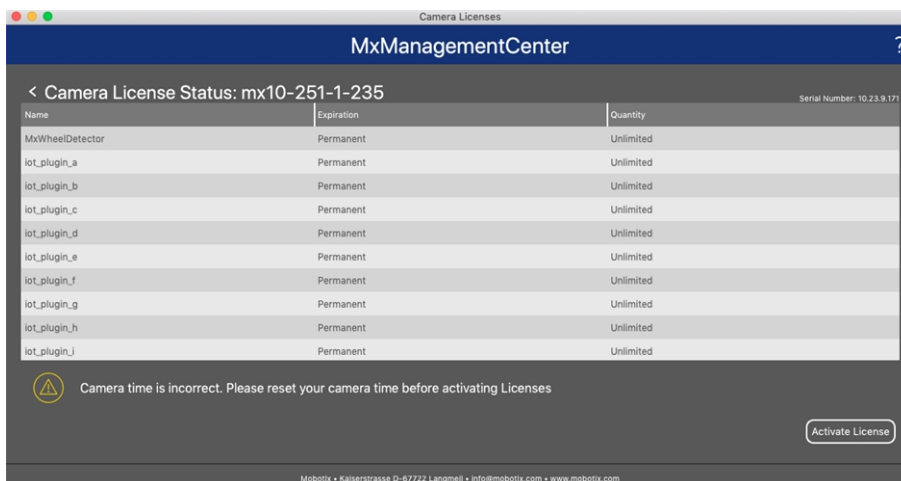

Fig. 2: Overview of the licenses installed on the camera

Note

If necessary, correct the time set on the camera.

2. Enter a valid Activation ID and specify the number of licenses to install on this computer.
3. If you want to license another product, click on . In the new row, enter the appropriate Activation ID and the number of licenses you want.
4. To remove a line click .

- When you have entered all Activation IDs, click **Activate License Online**. During activation, **MxMC** connects to the license server. This requires an Internet connection.

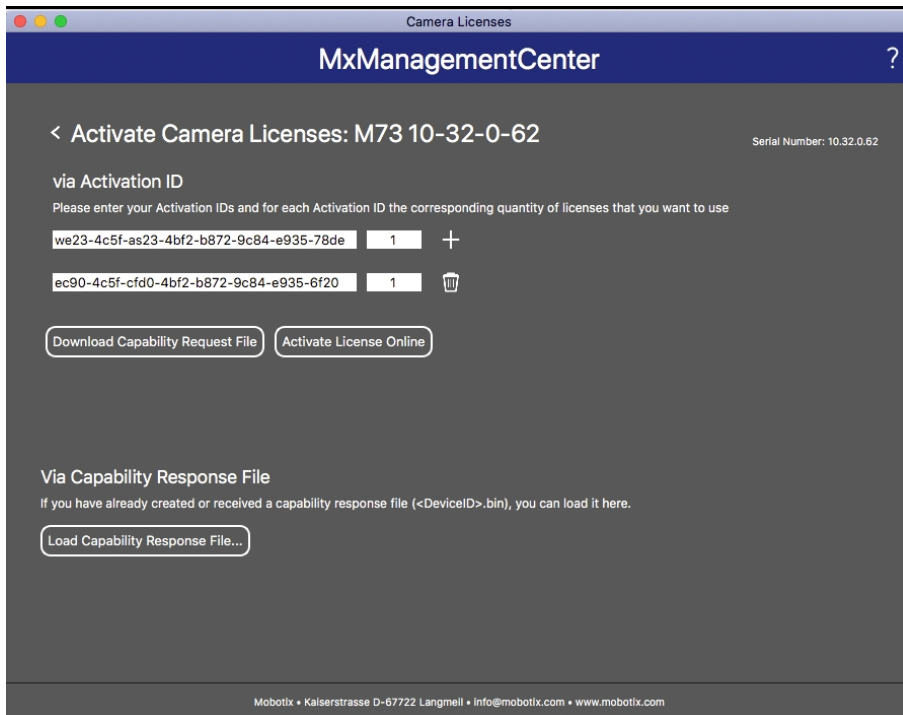

Fig. 3: Adding licenses

Successful activation

After successful activation, a new log in is required to apply the changes. Alternatively, you can return to license management.

Failed activation (missing internet connection)

If the license server cannot be reached, e.g. due to a missing internet connection, apps can also be activated offline. (see [Offline Activation](#), p. 10).

Offline Activation

For offline activation, the partner/installer from whom you purchased the licenses can generate a capability response (.bin file) on the license server to activate their licenses.

- Select from the menu **Window > Camera App Licenses**.
- Select the camera on which you want to license apps and click **Select**.

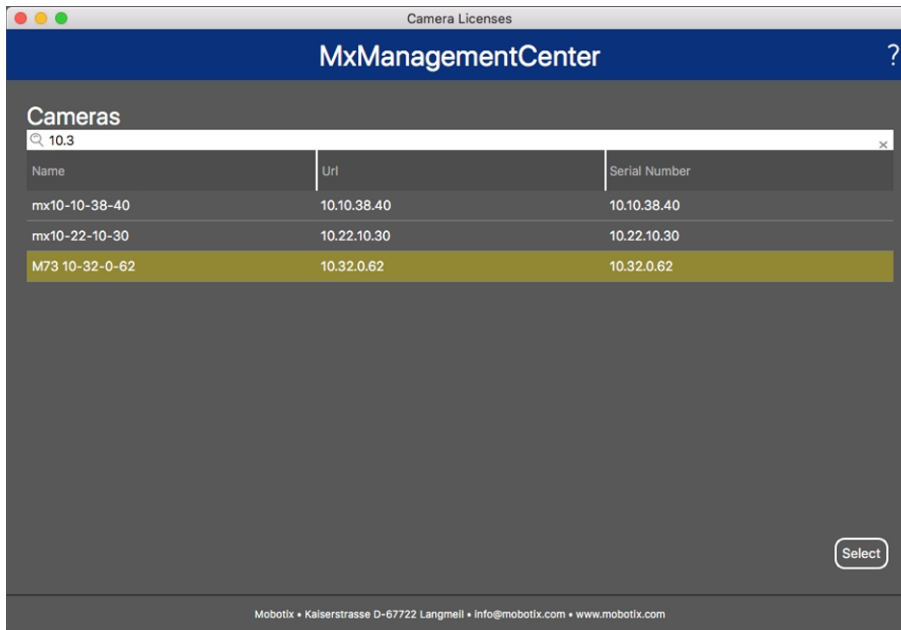

Fig. 4: Overview of Camera App Licenses in MxManagementCenter

Note

If necessary, correct the time set on the camera.

3. An overview of the licenses installed on the camera may be displayed. Click **Activate License**.

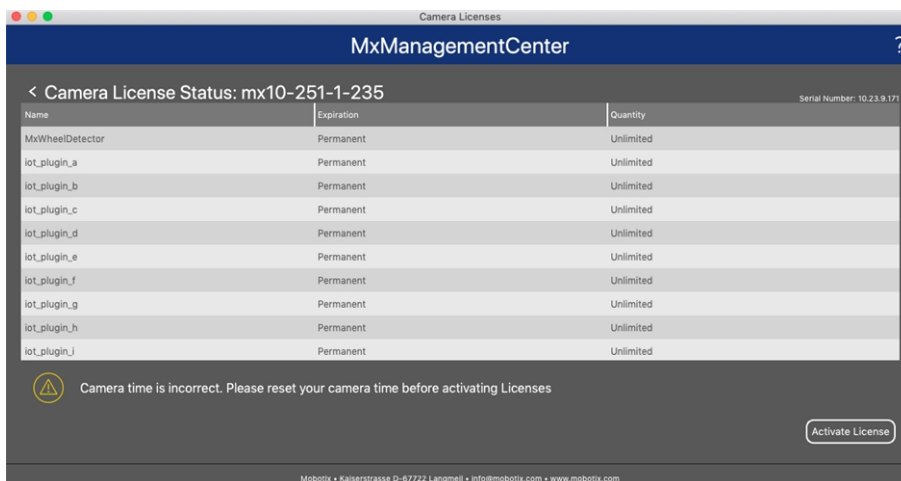

Fig. 5: Overview of the licenses installed on the camera

Note

If necessary, correct the time set on the camera.

4. Enter a valid Activation ID and specify the number of licenses to install on this computer.
5. If you want to license another product, click on . In the new row, enter the appropriate **Activation ID** and the number of licenses you want.
6. If necessary, click to remove a line.

- When you have entered all Activation IDs, click **Download Capability Request File (.lic)**, and send it to your partner/installer.

Note

This file allows the partner/installer from whom you purchased the licenses to generate a capability response file (.bin) on the license server.

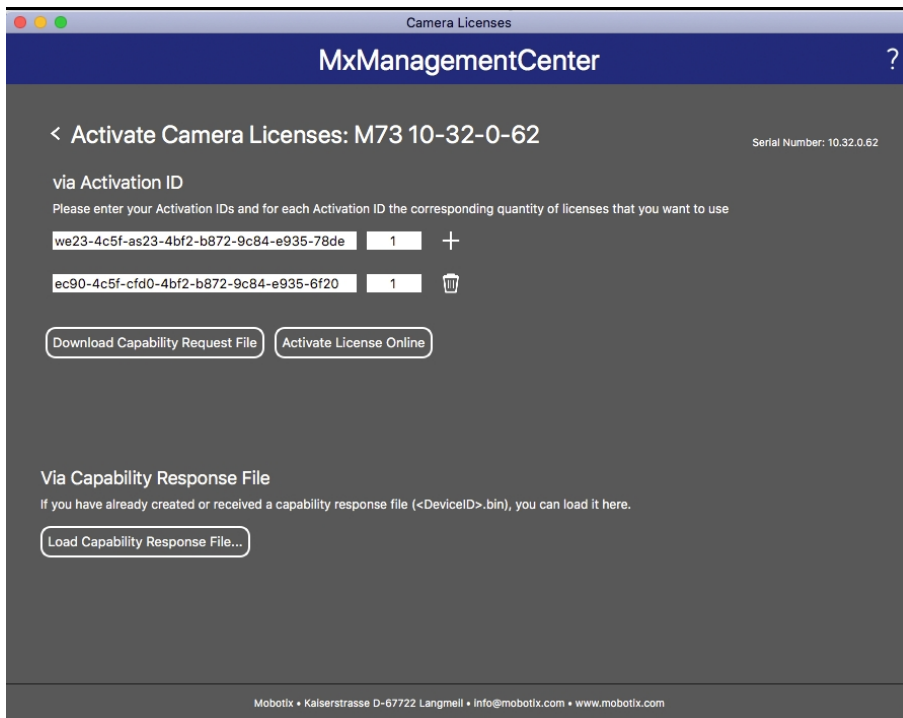

Fig. 6: Adding licenses

- Click Load Capability Response File and follow the instructions.

Successful activation

After successful activation, a new log in is required to apply the changes. Alternatively, you can return to license management.

Manage licenses

In the license management screen, you get a tabular overview of all licenses that have been activated for a camera.

- Select from the menu **Window > Camera App Licenses**.
- Select the camera on which you want to license apps and click **Select**.

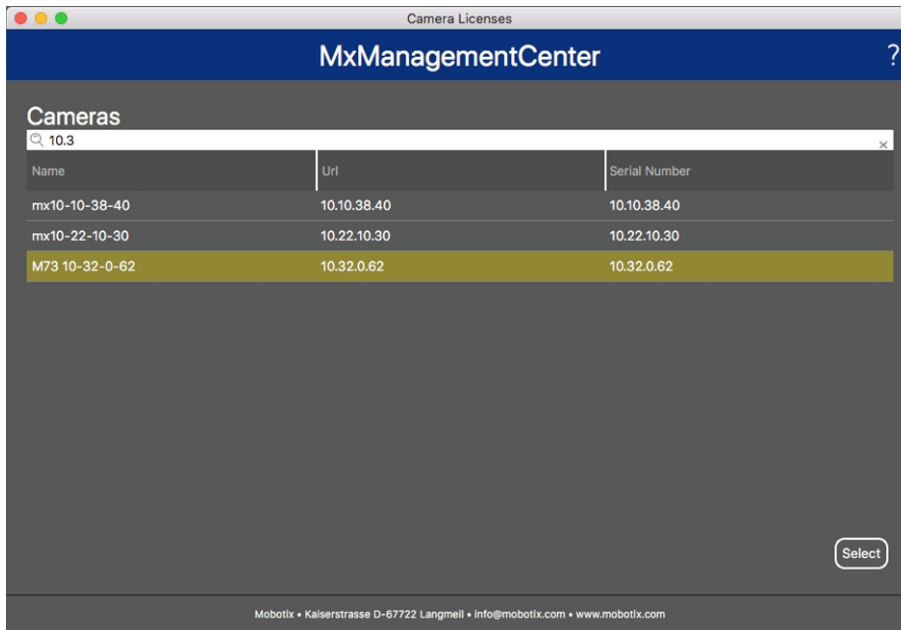

Fig. 7: Overview of Camera App Licenses in MxManagementCenter

An overview of the licenses installed on the camera may be displayed.



Fig. 8: Overview of the licenses installed on the camera

Note

If necessary, correct the time set on the camera.

Column	Explanation
Name	Name of the licensed app
Expiration	the time limit of the license
Quantity	Number of licenses purchased for a product.
Serial Number	Unique identification determined by MxMC for the device used. If problems occur during licensing, please have the device ID ready.

Synchronize licenses with server

When the program starts, there is no automatic comparison of the licenses between the computer and the license server. Therefore, click **Update** to reload the licenses from the server.

Update licenses

To update temporary licenses, click **Activate Licenses**. The dialog for updating/activating licenses opens.

Note

You need administrator rights to synchronize and update licenses.

Camera, image and scene requirements

In order to be able to recognize license plates in the best possible way, the following prerequisites must be fulfilled for the scene:

Quality of the license plate to be captured in the image

- The license plate must be high-contrast and clearly legible, i.e. as clean as possible, without dents or holes and well illuminated.
- The license plate should be rectangular
- Minimum horizontal size
 - 130 px for one-line plates (150 px for license plates from Russia, Kazakhstan, Armenia, Uzbekistan, Serbia)
 - 100 px for two line plates (130 px for license plates from Russia, Kazakhstan, Armenia, Uzbekistan, Serbia)
- Maximum rotation angle: 5°



- Maximum tilt angle of the license plate to the camera: 30° horizontal and vertical

Examples of clearly recognizable license plates



Easily readable license plate in daylight



Easily readable license plate at night with infrared LED illumination

Vertical pointing of the camera

The vertical angle to the registration plate must not exceed 30°. The minimum distance (x) from the camera as a function of its mounting height (h) is calculated by the formula:

$$x = h * \sqrt{3}$$

Example: calculation of the vertical alignment of the camera

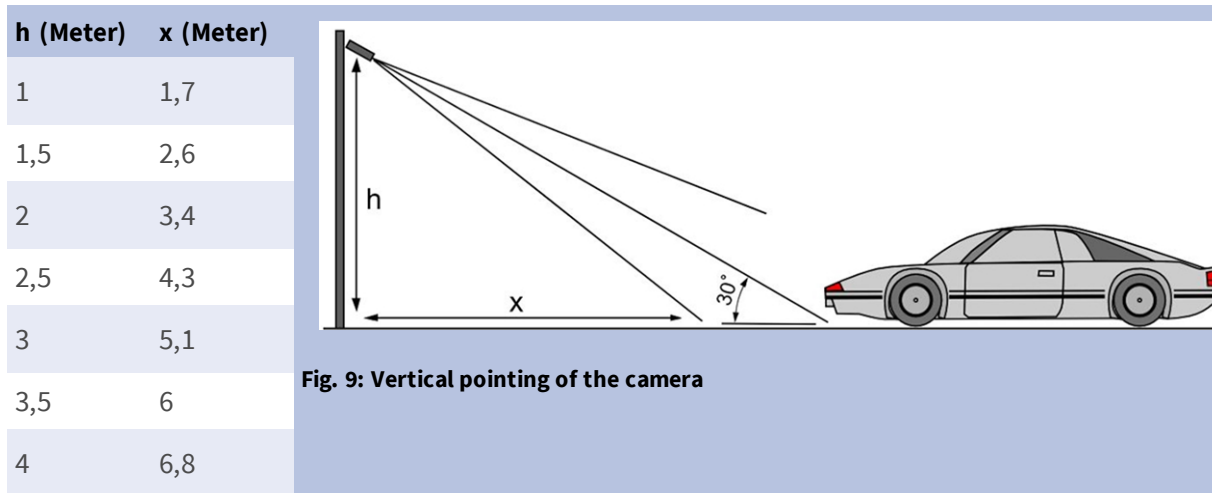

Fig. 9: Vertical pointing of the camera

Horizontal pointing of the camera

The horizontal angle to the registration plate must not exceed 30°. The minimum distance (x) from the camera as a function of its mounting height (y) is calculated by the formula:

$$x = y * \sqrt{3}$$

Sample calculation of the horizontal alignment of the camera

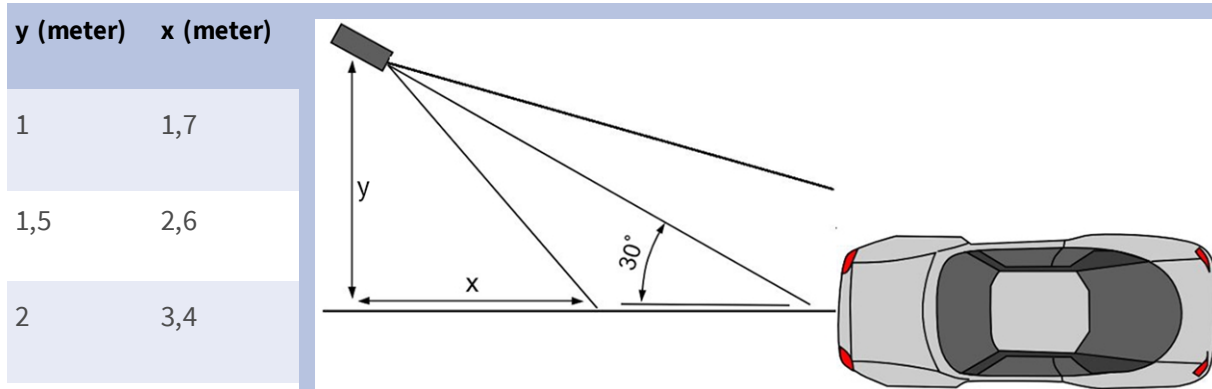
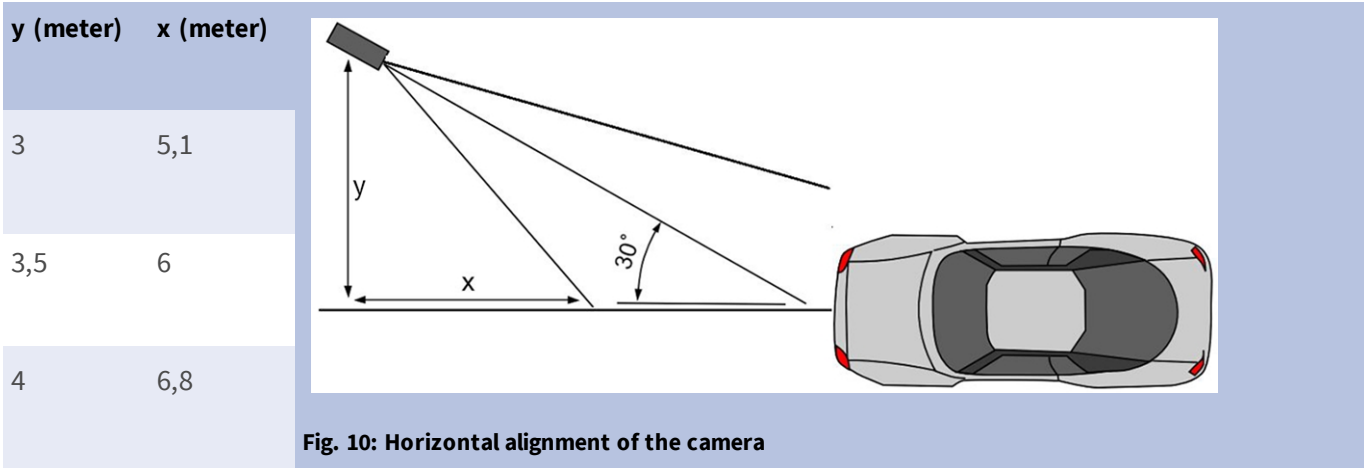

Fig. 10: Horizontal alignment of the camera



Depth of field in relation of vehicle speed and recognition time per plate

To effectively capture the vehicle camera should be set so as to provide the minimum depth of field (DOF). Depth-of-field (or length of the zone of sharpness) is the distance between the nearest and farthest objects that appear in acceptably sharp focus in a video.

The depth of field can be calculated by the formula:

$$L_{dof} = \frac{4 * T_{rec} * V_{max}}{3600}$$

Definition of the variables use in the formula

L_{dof} = depth of field in meters (m)

T_{rec} = recognition time per plate in milliseconds (ms)

V_{max} = maximum vehicle speed in kilometers per hour (km/h)

Example: calculation of typical cases

maximum vehicle speed in kilometers per hour (km/h)	recognition time per plate in milliseconds (ms)				
	100	200	300	400	500
depth of field in meters (m)					
40	4	9	13	18	22
80	9	18	27	36	44
100	11	22	33	44	56
120	13	27	40	53	67
140	16	31	47	62	78
180	20	40	60	80	100
200	22	44	67	89	111

Camera, image and scene requirements

Recommendations on mounting and adjusting.

maximum vehicle speed in kilometers per hour (km/h)	recognition time per plate in milliseconds (ms)				
	100	200	300	400	500
	depth of field in meters (m)				
220	24	49	73	98	122
240	27	53	80	107	133

Note

The minimum sizes of the license plate on the edges of the zone of sharpness must be at least as mentioned in [Quality of the license plate to be captured in the image, p. 15](#).

Note

For the best possible depth of field it is strongly recommended to manually adjust the camera's aperture settings instead of using the automatic settings.

Exposure time in relation to maximum vehicle speed

The exposure time must be adjusted to get the best results in recognition of license plates. Values are calculated for a camera mounted at a horizontal angle of 30 degrees.

Example: calculation of typical cases

exposure time in seconds (s)	maximum vehicle speed in kilometers per hour (km/h)
1/100	5
1/500	40
1/1000	100
1/2000	200
1/4000	400

Note

The exposure time must be adjusted according to the light conditions.

Recommendations on mounting and adjusting.

- If you want to recognize license plates on multiple lanes it is generally recommended to mount the camera on a crossbar.
- Use an IR Led to recognize license plates at night or under low light conditions.

- Shutter speed must be high enough to cut the light from car's headlights at night (usually it's about 1/1000). Keep in mind, that too high shutter speed may obscure the edges of the lines (especially shadows).
- Depth of focus is a very important parameter. If you are using a camera with a CS-mount lens, use a fixed lens. Fixed lens are better for license plate recognition due to greater depth of focus. Megapixel lens is also strongly recommended.
- Respect changing light conditions (e. g. due to sunrises and sunset) when choosing the place of mounting. Direct sunlight beams can distort a picture. If the cars facing a direct sunlight consider using a lens with auto iris mode.
- If mounting a camera on a roadside pole check how the pole reacts to heavy cars or a convoy of cars. Some poles have tangible tremor, this could make license plate recognition almost impossible.
- It is recommended to turn down WDR and BLC. In most cases, they will make the picture more pretty, but at the cost of smudging details like an edges of letters in the license plate. For the same reason keep digital noise reduction as low as possible.
- On certain rare conditions there may be a cases of false detections e. g. because of recognizing image parts that structurally or semantically look similar to a license plate(e. g. fences or ads). To minimize this:
 - Adjust the region of interest accordingly. It may be a good idea to make it smaller, or change it's shape, omitting the parts, which potentially may be false detected.
 - Adjust the min and max license plate settings according to upper instructions do not leave a default 130 - 300.
 - There may be cases, when the best performance will occur by changing angle of lens or moving the camera. In some cases, shooting a front license plate is better.

Troubleshooting

Blurred license plates can not be recognized

Problem: If you need to recognize multiple license plates of cars following one another a wider depth of field might be necessary. In the example below only the license plate in the green frame can be recognized.

Solution: adjust the lens focus to archive a higher depth of field.



Fig. 11: Insufficient depth of field

Problem: License plate is blurred due to wrong focus settings or to long exposure time.

Solution: Adjust focus settings or increase shutter speed



Fig. 12: Blurred license plate due to long exposure time

License plates cannot be recognized due to over exposure

Problem: In certain situations license plates can be over exposed and therefore no more readable. Possible cause could be direct sunlight shining on the license plates or to strong IR LED light at night.

Solution: Adjust shutter speed or dim IR LED light.



Fig. 13: Over exposed license plate at daytime



Fig. 14: Over exposed license plates due to too strong IR LED light

License plates cannot be recognized due to insufficient light

Problem: In certain situations there is not enough light which results in low contrast. Therefore license plates are not readable. Possible cause could be direct sunlight shining on the license plates or too strong IR LED light at night.

Solution: Adjust the shutter speed or provide extra light.



Fig. 15: Insufficient light to recognize license plate

License plates cannot be recognized due to low resolution

Problem: It seems that the license plate is well recognizable despite good illumination and sufficient resolution.

Solution: Measure the resolution of the license plate to be captured with an image processing program. It may be necessary to adjust the horizontal resolution to the minimum required 130 px (see [Camera, image and scene requirements](#), p. 15).



Fig. 16: Insufficient light to recognize license plate

Activation of the Certified App Interface

Attention

The FF Group License Plate Recognition App - Region EUCA does not consider obscure areas defined for the live image. Therefore there is no pixelation in obscure areas while configuring the app and during image analysis by the app.

Note

The user must have access to the setup menu ([http\(s\)://<Camera IP address>/control](http(s)://<Camera IP address>/control)). Therefore check the user rights of the camera.

Activation of Certified Apps and events

1. In the camera web interface, open: **Setup Menu / Certified App Settings** ([http\(s\)://<Camera IP address>/control/app_config](http(s)://<Camera IP address>/control/app_config)).

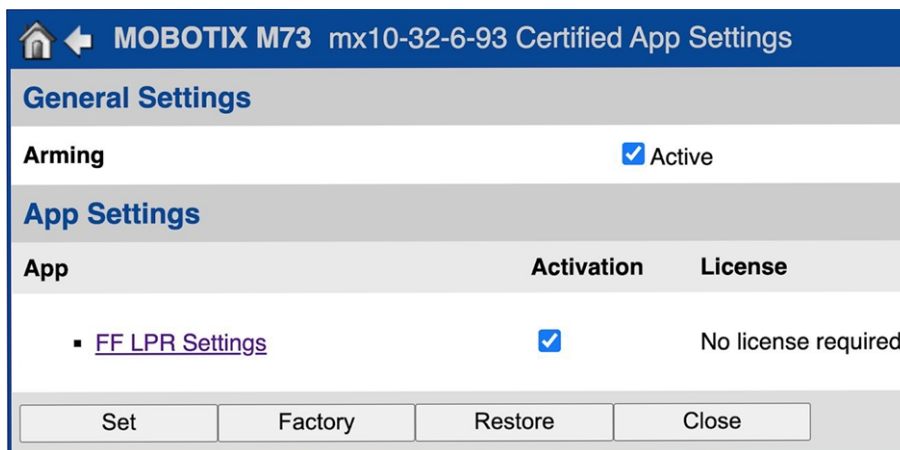

Fig. 17: Certified App: Settings

2. Under **General Settings** activate the **Arming** of the app service (see screenshot).
3. Under **App Settings** check the **Active** option and click **Set**.
4. Click on the name of the App to be configured to open the Apps user interface.
5. For configuration of the App see [Configuration of FF Group License Plate Recognition App - Region EUCA](#), p. 24.

Configuration of FF Group License Plate Recognition App - Region EUCA

Note

For best performance and results in LPR processing make sure to have scene set up to meet the [Camera, image and scene requirements](#), p. 15.

Attention

The user must have access to the setup menu ([http\(s\)://<Camera IP address>/control](http(s)://<Camera IP address>/control)). Therefore check the user rights of the camera.

1. In the camera web interface, open: **Setup Menu / Certified App Settings** ([http\(s\)://<Camera IP address>/control/app_config](http(s)://<Camera IP address>/control/app_config)).
2. Click on the name of the **FF Group License Plate Recognition App - Region EUCA**.

The configuration window of the app appears with the following options:

Basic settings

FFLPRAM	
Sensor Selection	Automatic <input type="button" value="v"/> Select the image sensor
Image Size	3840x2160 <input type="button" value="v"/> Defines the image size, which is used as basis for the license plate recognition. Factory default: 4K Ultra HD (3840x2160)
Enable Overlays	<input type="checkbox"/> Highlight recognized license plates and enable the on-screen text overlay
Enable MxMessage	<input type="checkbox"/> Send an MxMessage for each license plate recognized. The MxMessage is required for the configuration of Message Events on the camera and for the usage of the MxMC Smart Data Interface.
Region	USA <input type="button" value="v"/> Recognition of number plates within the selected region. For countries belonging to the region, see the app documentation.
<input type="button" value="▶"/> Recognition Zones	
<input type="button" value="▶"/> Integration Interfaces	
<input type="button" value="▶"/> Whitelist	
<input type="button" value="▶"/> Blacklist	
<input type="button" value="▶"/> Installation Tools	
<input type="button" value="Set"/> <input type="button" value="Factory"/> <input type="button" value="Restore"/> <input type="button" value="Close"/>	

Fig. 18: Default operating mode: Detection

Resolution: Select the resolution for the video stream to be analyzed by FF Group License Plate Recognition App - Region EUCA (Default: 4K Ultra HD (3840x2160)).

Note

The resolution for LPR processing could be different from the resolution used for live stream.

Enable Overlays: Check to highlight recognized license plates and enable the on-screen text overlay in the live view.

Enable MxMessage: Check to enable sending an MxMessage for each license plate recognized. The MxMessage is required for the configuration of Message Events on the camera and for the usage of the MxMC Smart Data Interface.

Region: Select the region to be set for the LPR engine. These regions are:

USA: All US American license plate types

Recognition Zones

Up to three recognition areas can be defined. Each recognition zone is evaluated by the LPR engine independently of the others. Accordingly, each zone is assigned an individual ID (zone number).

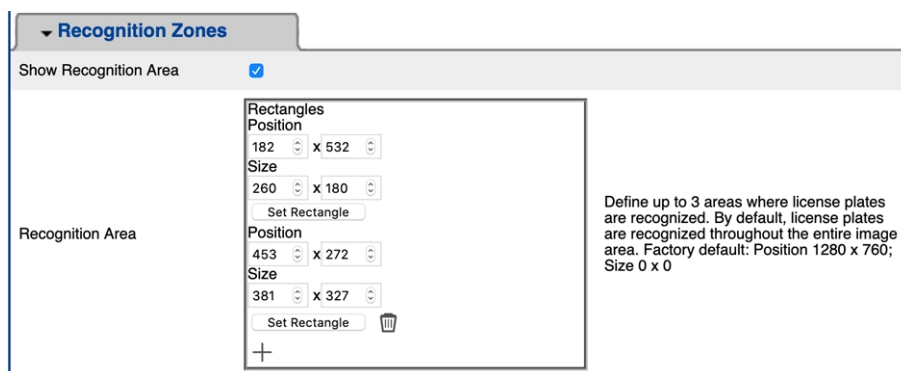

Fig. 19: Recognition Areas

Drawing a Region Area

1. In the live view hold the **Shift** key and click the upper left corner point of the region area
2. Release the **Shift** key and click on the lower right corner point of the area.
3. In the configuration interface click **Set Rectangle** to adopt the coordinates of the rectangle.
4. Optionally click the **plus** icon to add another recognition area.
5. Optionally click the **bin** icon to delete a recognition area.
6. Check **Show Recognition Area** to show the recognition area in the live view.

Note

without activating the zones the full image will be analyzed.

Integration Interfaces

LPR events can be send to 3rd party systems, e. g. Access Control Systems or Video Management Systems. Therefore the following configurations should be taken into account:

▼ Integration Interfaces		
Enable	<input type="checkbox"/>	Enable the integration interface to send IP notifications to a defined external receiver (e.g. 3rd party access control systems, video management system, etc.)
Destination Address	<input type="text" value="http://server.address"/>	Receiver / Server IP address and port. Separate IP address and port using a colon (e.g. 10.0.0.1:80)
Transfer Protocol	<input type="text" value="HTTP(s) POST"/>	Transfer notification data using these protocol headers
Device ID	<input type="text" value="defaultID"/>	Device ID is used as unique identifier for the device sending the IP notification (e.g. camera's serial number / factory IP address)
Attach Image	<input type="checkbox"/>	Enable to attach an event image to the IP notification
Image Selection	<input type="text" value="License plate crop"/>	Selection of the event image to be attached to the IP notification
Event Type: New	<input type="checkbox"/>	Send the IP notification for event type 'new'. nCondition 'new' becomes true, if the license plate appears for the first time in 5 seconds
Event Type: Update	<input type="checkbox"/>	Send the IP notification for event type 'update'. nCondition 'update' becomes true, if the license plate was already detected in the last 5 seconds
Event Type: Lost	<input type="checkbox"/>	Send the IP notification for event type 'lost'. nCondition 'lost' becomes true, if plate was not seen in the last 5 seconds since previous detection
self-signed certificates	<input type="checkbox"/>	Allow self-signed certificates for HTTPS

Fig. 20: Integration Interfaces

Enable: Check to enable the integration interface to send IP notifications to a defined external receiver (e.g. 3rd party access control systems, video management system, etc.).

Destination Address: Receiver / Server IP address and port. Separate IP address and port using a colon (e.g. 10.0.0.1:80).

Transfer Protocol: Select the protocol on the basis of which the LPR events are transmitted.

TCP: Data will be transmitted via TCP.

HTTP POST: Data will be transmitted via FFG protocol. [Download a detailed description.](#)

Device ID: Set an unique text string to identify your camera device in messages. Device ID is used as unique identifier for the device sending the IP notification (e.g. camera's serial number / factory IP address).

Attach Image: Check to attach an event image to the IP notification.

Image Selection: If images should be send select the image type here:

License plate crop: The image contains the license plate only.

Vehicle crop: The image contains the vehicle with the recognized license plate.

Full frame: the full image is transmitted.

Event Type: New: Check to send an IP notification for event type 'new'. Condition 'new' becomes true, if the license plate appears for the first time in 5 seconds.

Event Type: Update: Check to send an IP notification for event type 'update'. Condition 'update' becomes true, if the license plate was already detected in the last 5 seconds.

Event Type: Lost: Check to send an IP notification for event type 'lost'. Condition 'lost' becomes true, if

plate was not seen in the last 5 seconds since previous detection.

Self signed certificates: Allow self signed certificates for HTTPS.

Black List & White List

You can define a black list and a white list with up to 1000 license plates per list. If a license plate from one of the lists is recognized, a corresponding event is sent within the MxMessageSystem of the camera.

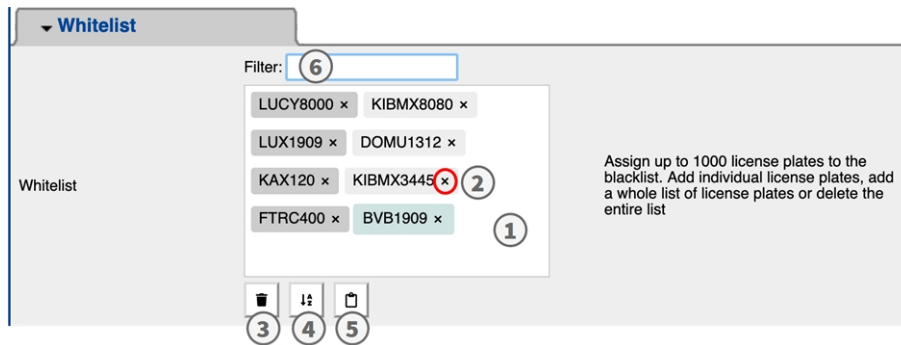

Fig. 21: Black and white lists

Adding a license plate to a list

1. Enter the license plate text into the text field ① and click **Enter**.

Adding multiple license plates from a text file

1. Make sure that your text file contains one license plate per line.
2. Copy the relevant license plates from the text file and paste them into the text field ①.

Deleting a license plate from a list

1. Click on the small x ② to the right of the license plate number.

Deleting all license plates from a list

1. Click the trash icon ③.

Sorting all license plates from a list alphabetically

1. Click the sort icon ④.

Copy all license plates from a list to the clip board

1. Click the copy to clipboard icon ⑤.

Filtering license plates

1. Enter the license plate or parts of it into the filter text field ⑥. Only license plates containing the filter text are displayed accordingly.

Installation Tools

In this section you find useful tools for calibration and trouble shooting.

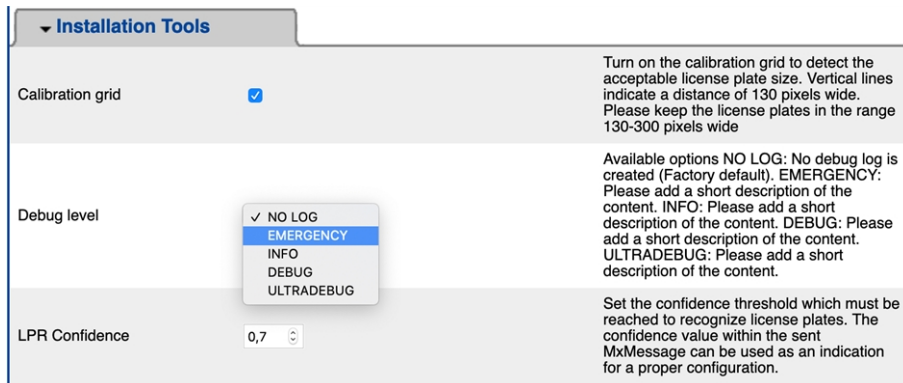

Fig. 22: Installation Tools

Calibration grid: Turn on the calibration grid to detect the acceptable license plate size. Vertical lines indicate a distance of 130 pixels wide. Please keep the license plates in the range 130-300 pixels wide.

Color Confidence: Set the confidence threshold which must be reached to recognize color of the vehicle. The confidence value within the sent MxMessage can be used as an indication for a proper configuration.

Debug level: Select a debug level to generate a log file, which can be helpful e.g. for trouble shooting.

NOLOG: no debug log is created (default setting)

EMERGENCY

INFO

DEBUG

ULTRADEBUG

LPR Confidence: Set the confidence threshold which must be reached to recognize license plates. The confidence value within the sent MxMessage can be used as an indication for a proper configuration.

Attention

Wrong settings can lead to bad recognition results. In most cases the default settings are sufficient.

Storing the Configuration

To store the configuration you have the following options:



Fig. 23: Storing the configuration

- Click on the **Set** button to activate your settings and to save them until the next reboot of the camera.
- Click on the **Factory** button to load the factory defaults for this dialog (this button may not be present in all dialogs).
- Click on the **Restore** button to undo your most recent changes that have not been stored in the camera permanently.

- Click on the **Close** button to close the dialog. While closing the dialog, the system checks the entire configuration for changes. If changes are detected, you will be asked if you would like to store the entire configuration permanently.

After successfully saving the configuration, the event and meta data are automatically sent to the camera in case of an event.

About MxMessageSystem

What is MxMessageSystem?

MxMessageSystem is a communication system based on name oriented messages. This means that a message must have a unique name with a maximum length of 32 bytes.

Each participant can send and receive messages. MOBOTIX cameras can also forward messages within the local network. This way, MxMessages can be distributed over the entire local network (see Message Area: Global).

For example, a MOBOTIX 7 series camera can exchange an MxMessage generated by a camera app with an Mx6 camera that does not support certified MOBOTIX apps.

Facts about MxMessages

- 128-bit encryption ensures privacy and security of message content.
- MxMessages can be distributed from any camera of the Mx6 and 7 series.
- The message range can be defined individually for each MxMessage.
 - **Local:** Camera expects an MxMessage within its own camera system (e.g. through a Certified App).
 - **Global:** the camera expects an MxMessage that is distributed in the local network by another MxMessage device (e.g. another camera of the 7 series equipped with a certified MOBOTIX app).
- Actions that the recipients are to perform are configured individually for each participant of the MxMessageSystem.

Basic configuration: Processing the automatically generated app events

Checking automatically generated app events

Note:

After successfully activating the app (see [Activation of the Certified App Interface, p. 23](#)), a generic message event for this specific app is automatically generated in the camera.

- To check the event go to **Setup-Menu / Event Control / Event Overview**.
- The automatically generated message event profile is named after the application (e. g. FFLPR).

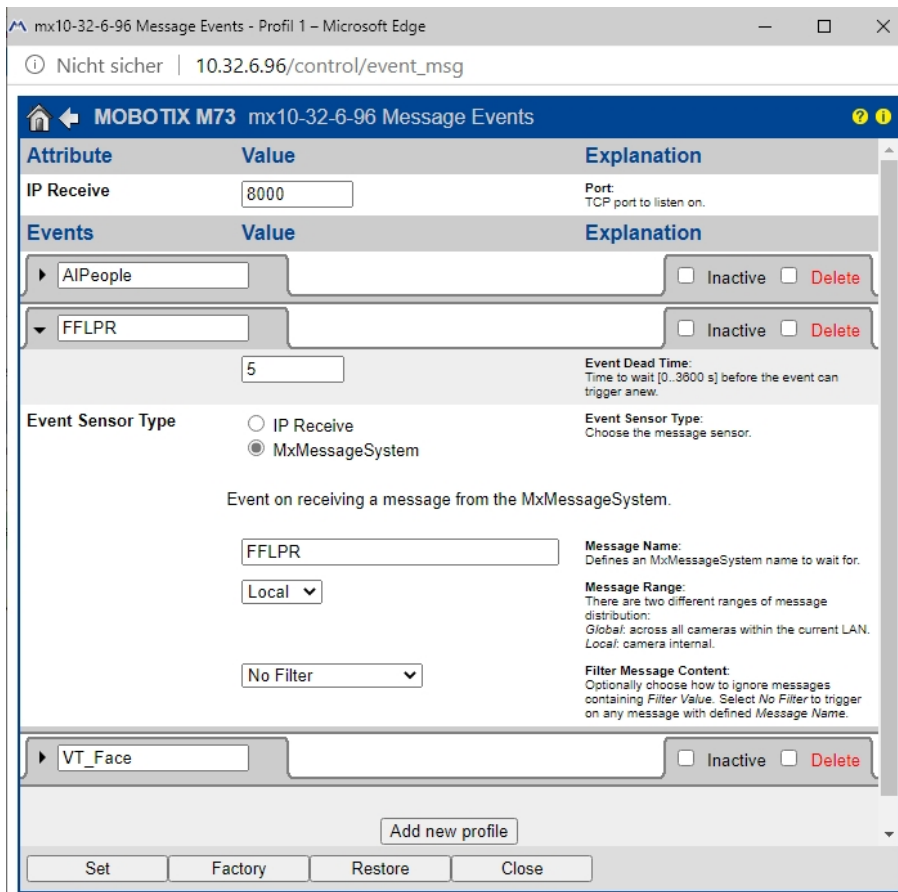

Fig. 24: Example: Generic message event from FF Group License Plate Recognition App - Region EUCA

Action handling - Configuration of an action group

Attention

To use events, trigger action groups or record images the general arming of the camera must be enabled (http(s)/<Camera IP address>/control/settings)

An action group defines which action(s) is (are) triggered by the FF Group License Plate Recognition App - Region EUCA event.

1. In the camera web interface, open: **Setup Menu / Action Group Overview** (http(s)://<Camera IP address>/control/actions).

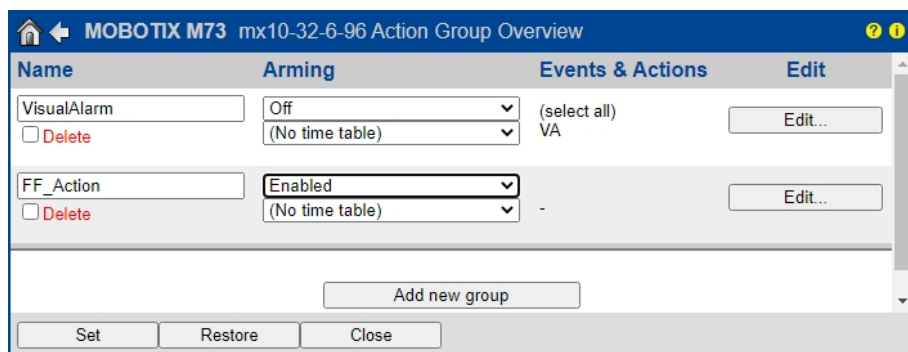

Fig. 25: Defining Action Groups

- Click **Add new group** and give a meaningful name.
- Click **Edit**, to configure the group.

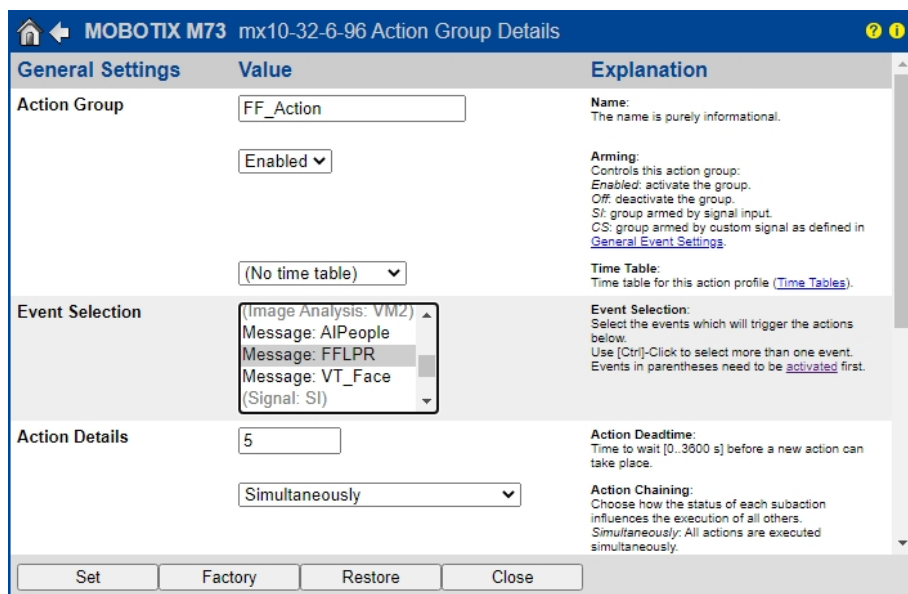

Fig. 26: Configuring an Action Group

1. Activate **Arming** of the Action Group.
2. Select your message event in the **Event selection** list. To select multiple events, press the shift key.

3. Click **Add new Action**
4. Select a proper action from list **Action Type and Profile.**

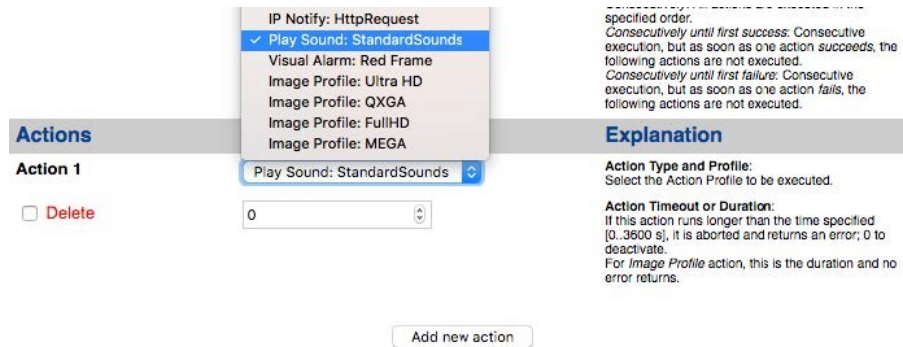

Fig. 27: Select Action Type- and Profile

Note

If the required action profile is not yet available, you can create a new profile in the Admin Menu sections "MxMessageSystem", "Transfer Profiles" and "Audio and VoIP Telephony".
 If necessary, you can add further actions by clicking the button again. In this case, please make sure that the "action chaining" is configured correctly (e.g. at the same time).

5. Click on the **Set** button at the end of the dialog box to confirm the settings.

Action settings - Configuration of the camera recordings

1. In the camera web interface, open: **Setup Menu / Event Control / Recording**(http(s)/<Camera IP address>/control/recording).

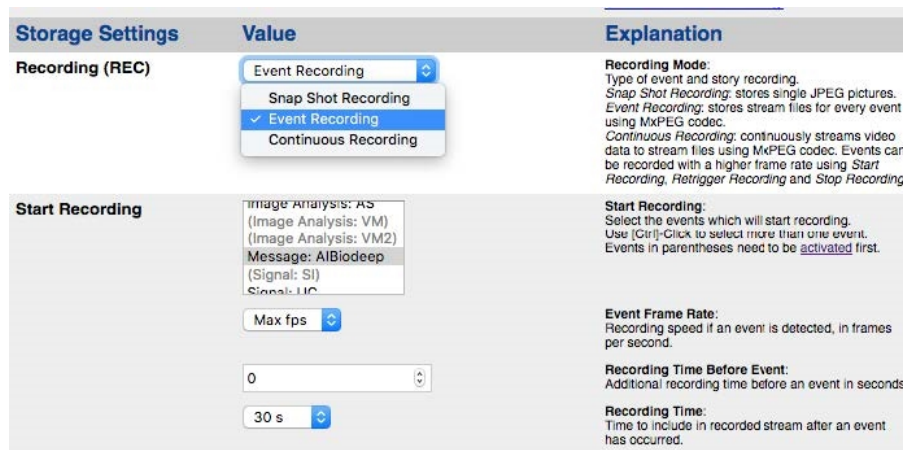

Fig. 28: Configuration of camera recording settings

2. Activate **Arm Recording.**
3. Under **Storage Settings / Recording (REC)** select a **Recording mode.** The following modes are available:
 - Snap Shot Recording
 - Event Recording

Basic configuration: Processing the automatically generated app events

Facts about MxMessages

- Continuous Recording

4. In list **Start recording** select the message event just created.
5. Click on the **Set** button at the end of the dialog box to confirm the settings.
6. Click on **Close** to save your settings permanently.

Note

Alternatively, you can save your settings in the Admin menu under Configuration / Save current configuration to permanent memory.

Advanced Configuration: Processing the meta data transmitted by apps

Meta data transferred within the MxMessageSystem

For each event, the app also transfers meta data to the camera. This data is sent in the form of a JSON schema within an MxMessage.

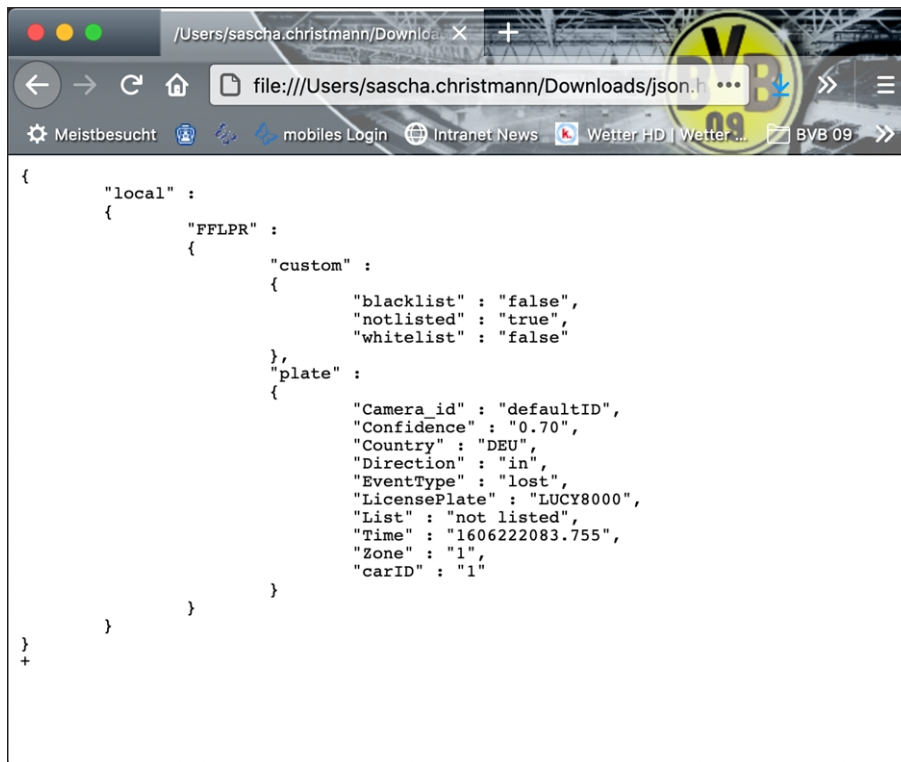
A screenshot of a web browser window displaying a JSON schema. The browser's address bar shows a file path: file:///Users/sascha.christmann/Downloads/json.h... The page content shows a nested JSON object. The outermost object has a "local" property, which is another object containing an "FFLPR" property. This "FFLPR" object has a "custom" property (an object with "blacklist", "notlisted", and "whitelist" fields) and a "plate" property (an object with various fields like "Camera_id", "Confidence", "Country", "Direction", "EventType", "LicensePlate", "List", "Time", "Zone", and "carID").

```
{
  "local" :
  {
    "FFLPR" :
    {
      "custom" :
      {
        "blacklist" : "false",
        "notlisted" : "true",
        "whitelist" : "false"
      },
      "plate" :
      {
        "Camera_id" : "defaultID",
        "Confidence" : "0.70",
        "Country" : "DEU",
        "Direction" : "in",
        "EventType" : "lost",
        "LicensePlate" : "LUCY8000",
        "List" : "not listed",
        "Time" : "1606222083.755",
        "Zone" : "1",
        "carID" : "1"
      }
    }
  }
}
```

Fig. 29: Example: Meta data transmitted within an MxMessage of the FF Group License Plate Recognition App - Region EUCA

Note:

To view the meta data structure of the last App event, enter the following URL in the address bar of your browser: [http\(s\)/IPAddressOfYourCamera/api/json/messages](http(s)/IPAddressOfYourCamera/api/json/messages)

Creating a Custom Message Event

1. In the camera web interface, open: **Setup Menu / Event Control / Event Overview**
([http\(s\)://<Camera IP address>/control/event_msg](http(s)://<Camera IP address>/control/event_msg))

The screenshot shows the configuration page for a custom message event. At the top, there is a dropdown menu with 'FFLPR' selected, and buttons for 'Inactive' and 'Delete'. Below this is a numeric input field set to '5' and a section for 'Event Dead Time' with a description: 'Time to wait [0..3600 s] before the event can trigger anew.' The 'Event Sensor Type' is set to 'MxMessageSystem' (selected with a radio button), with 'IP Receive' as an alternative. The event description is 'Event on receiving a message from the MxMessageSystem.' The 'Message Name' is 'FFLPR.custom.blacklist'. The 'Message Range' is set to 'Local'. The 'Filter Message Content' is set to 'JSON Comparison'. The 'Filter Value' is 'true'. A text area on the right provides detailed instructions for each field: 'Message Name' defines the name to wait for; 'Message Range' explains 'Local' (camera internal) vs 'Global' (all cameras); 'Filter Message Content' explains 'No Filter' vs 'JSON Comparison'; and 'Filter Value' explains it can be a string or a regular expression, and mentions variables.

Fig. 30: Example configuration of a user-defined "blacklist" event

2. Configure the parameters of the event profile as follows:

- **Profile Name:** Enter an event related / application related profile name that illustrates the purpose of the profile.
- **Message Name:** Enter the "Message Name" according to the event documentation of the corresponding app (see table [Examples for message names and filter values of the FF Group License Plate Recognition App - Region EUCA](#), p. 37 below)
- **Message Range:**
 - Local: Default settings for the FF Group License Plate Recognition App - Region EUCA
 - Global: (MxMessage is forwarded from another MOBOTIX camera in the local network.
- **Filter Message Content:**
 - Generic Event: "No Filter"
 - Filtered Event: "JSON Equal Compare"

Filter Value: see table [Examples for message names and filter values of the FF Group License Plate Recognition App - Region EUCA](#), p. 37.

Note

"Filter Value" is used to differentiate the MxMessages of an app / bundle. Use this entry to benefit from individual event types of the apps (if available).

Choose "No Filter" if you want to use all incoming MxMessages as generic event of the related app.

2. Click on the **Set** button at the end of the dialog box to confirm the settings.

Examples for message names and filter values of the FF Group License Plate Recognition App - Region EUCA

FF Group License Plate Recognition App - Region EUCA	MxMessage Name	Filter Value
Generic Event	FFLPR	“recognizedPersons”
Whitelist Event	FFLPR.custom.whitelist	“true”
Blacklist Event	FFLPR.custom.blacklist	“true”
Not listed Event	FFLPR.custom.notlisted	“true”
Unique license plate event	FFLPR.plate.LicensePlate	License plate code as “STRING”; e.g., “LUCY8000” (see Meta data transferred within the MxMessageSystem, p. 35)
Incoming Vehicle Event	FFLPR.plate.Direction	“in”
Outgoing Vehicle Event	FFLPR.plate.Direction	“out”



[EN_03/21](#)

MOBOTIX AG • Kaiserstrasse • D-67722 Langmeil • Tel.: +49 6302 9816-103 • sales@mobotix.com • www.mobotix.com

MOBOTIX is a trademark of MOBOTIX AG registered in the European Union, the U.S.A., and in other countries. Subject to change without notice. MOBOTIX do not assume any liability for technical or editorial errors or omissions contained herein. All rights reserved. © MOBOTIX AG 2020