

Quick Installation

MOBOTIX 4K (8MP) Vandal Fixed Dome Analytics Camera Mx-VD1A-8-IR-VA

© 2021 MOBOTIX AG

NOTE!

This guide is only valid for installing and connecting the 4K (8MP) Vandal Fixed Dome Analytics Camera. For more information, refer to the corresponding User Guide.

Important Installation Notes

- This camera must be installed by qualified personnel and the installation should conform to all local codes.
- To prevent damage, loosen the mounting screws before moving the camera.
- To ensure that the unit is not affected by vibration, twisting, etc. after adjusting the camera, tighten all mounting screws properly.
- This product must not be used in locations exposed to the dangers of explosion.
- Install this product in a well-ventilated spot and do not close off any vent openings.
- Do not use this product in a dusty environment.
- Protect this product from moisture or water entering the housing.
- Install this product as outlined in this document. A faulty installation can damage the product!
- Do not replace batteries of the camera. Risk of explosion may occur if the battery is replaced by an incorrect type.
- This equipment is not suitable for use in locations where children are likely to be present.
- External power supplies must comply with the LPS requirements and share the same power specifications with the camera.
- If using a Class I adapter, the power cord shall be connected to a socket-outlet with proper ground connection.
- To comply with the requirements of EN 50130-4 regarding the power supply of alarm systems for 24/7 operation, it is highly recommended to use an uninterruptible power supply (UPS) for powering the product.
- This equipment is to be connected only to PoE networks without routing to other networks.

Camera Connectors

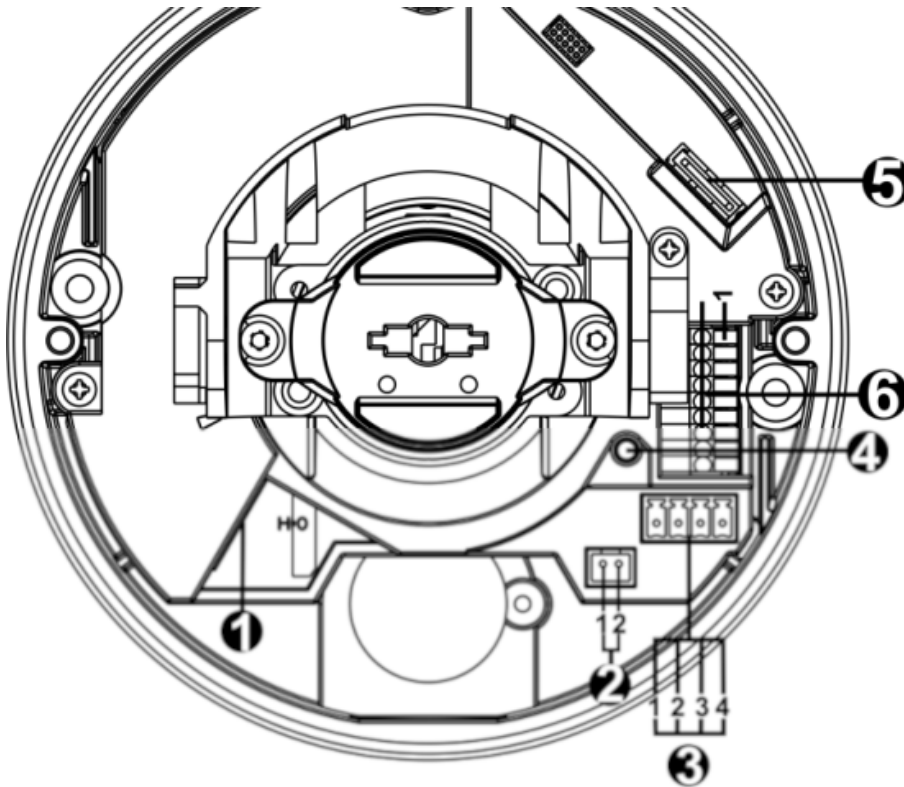

No.	Connector	Pin	Definition	Remarks
1	RJ-45	-	For network and PoE connections	
2	BNC*	1	BNC	For analog video output
		2	GND	
3	Power (DC 12V / AC 24V)	1	AC 24V 1	Power connection
		2	AC 24V 2	
		3	DC 12V 1	
		4	DC 12V 2	
4	Default Button	-	Press the default button with a proper tool for at least 20 seconds to restore the camera.	
5	microSD Card Slot	-	Insert the microSD card into the card slot to store videos and snapshots. Do not remove the microSD card when the camera is powered on.	

No.	Connector	Pin	Definition	Remarks
6	Alarm & Audio I/O	1	Audio In L	Audio In (Line In)
		2	Audio In R	
		3	GND	Ground connection
		4	Audio Out L	Audio Out (Line Out)
		5	Audio Out R	
		6	Alarm Out +	Alarm connection>
		7	Alarm Out -	Do NOT connect external power supply to the alarm I/O connector of the IP camera.
		8	Alarm In +	
		9	Alarm In -	

*Contact the manufacturer for the compatible BNC cable.

NOTE! It is not recommended to record with the microSD card for 24/7 continuously, as it may not be able to support long term continuous data read / write. Please contact the manufacturer of the microSD card for information regarding the reliability and life expectancy of the product.

Camera Cabling

Power Connection

Use a DC 12V/AC 24V adapter and connect it to the 2-pin terminal block of the All-in-One cable and the power outlet. Alternatively, connect the Ethernet cable to the RJ-45 connector of the All-in-One cable, and plug the other end of the cable to a suitable Power Sourcing Equipment (PSE) / Power over Ethernet (PoE) switch.

NOTE! If PoE is used, make sure PSE is in use in the network.

Zero Downtime Power Switching (ZDT)

Connect the camera to an AC 24V or PoE power source as the main power supply, and then connect DC 12V as the secondary power supply. If the main power source fails, the camera will switch power input seamlessly to the DC12V port until the main power source is restored.

Ethernet Cable Connection

Connect one end of the Ethernet cable to the RJ-45 connector of the camera, and plug the other end of the cable to the network switch or PC.

NOTE! In some cases, Ethernet crossover cable might be needed when connecting the camera directly to the PC.

NOTE! Check the status of the link indicator and the activity indicator LEDs. If the LEDs are unlit, please check the LAN connection.



Green Link Light indicates good network connection.

Orange Activity Light flashes for network activity indication.

NOTE! The ITE is to be connected only to PoE networks without routing to the outside plant or equivalent description.

Accessing the Camera

The 4K (8MP) Vandal Fixed Dome Analytics Camera supports all current browsers without requiring any additional plug-in or add-on (e. g. for H.264 / MJPEG support). Microsoft Internet Explorer with ActiveX is recommended for best performance and H.265 support

A client program will be automatically installed to the PC when connecting to the camera. If using Microsoft Internet Explorer, ensure downloading the ActiveX control is allowed by either changing the ActiveX controls and plug-in/add-on (H.264 and MJPEG) or setting Internet's security level to default.

ActiveX Controls and Plug-ins Settings

1. Start the Internet Explorer (IE).
2. Select **Tools** from the main menu of the browser. Then click on **Internet Options**.
3. Click on the **Security** tab and select **Internet**, and click on **Custom level** to change ActiveX settings.
4. Set "ActiveX controls and plug-ins" items to **Prompt** or **Enable**.

Internet Security Level Settings

1. Start the Internet Explorer (IE).
2. Select **Tools** from the main menu of the browser. Then click on **Internet Options**.
3. Click on the **Security** tab and select **Internet**.
4. Down the page, click on **Default Level** and **OK** to confirm the setting. Close the browser window.

Camera Login

The default IP address of the camera is: 10.x.x.x. By default, the camera starts as DHCP client and automatically tries to get an IP address from a DHCP server.

1. Enter the camera's IP address in the URL bar of the web browser and hit "Enter".
2. Enter the default username (**admin**) and password (**meinsm**).

NOTE! ID and password are case sensitive.

CAUTION! It is strongly advised to change the default password. Refer to the menu tree of your camera for further details.

3. In the Viewer installation window, click on **Next** to start installation.

- The status bar will show the installation progress. After the installation is completed, click on **Finish** to exit the installation process.
- Click on **Finish** to close the Viewer installation page.

NOTE! Once the Viewer is successfully installed, the Home page of the IP camera will be displayed as the figure below.

Browser-Based Viewer

The main page of the IP camera user interface is shown as the figure below. The function buttons vary depending on the camera model.

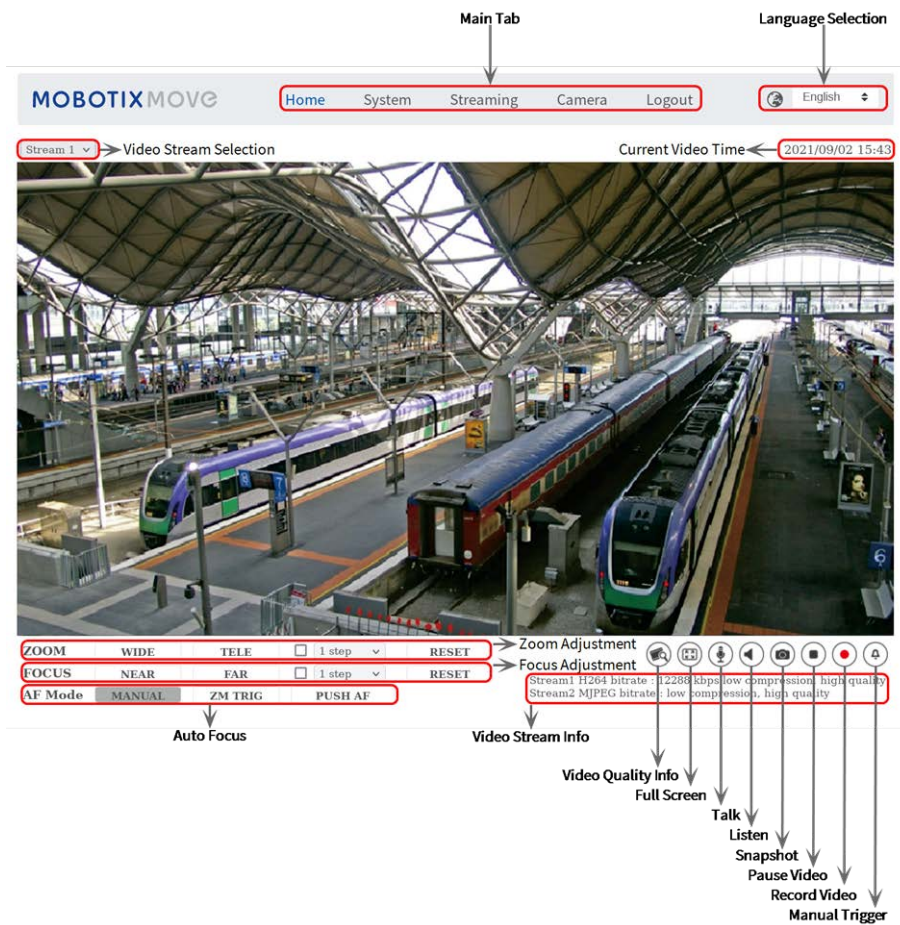

Camera Maintenance

It is recommended that you perform the following maintenance tasks at regular intervals to keep the 4K (8MP) Vandal Fixed Dome Analytics Camera in good working condition:

- Clean the dome using plain water and a soft cloth.

CAUTION! Do not use any detergents or alcohol to prevent damage to the coating!

- Check the mounting and make sure that all screws are properly tightened to prevent the camera from falling down.

Quick Installation 4K (8MP) Vandal Fixed Dome Analytics Camera

- When opening the camera, add a silica gel dry pack to prevent condensation accumulating at the dome.

MOBOTIX

BeyondHumanVision

[EN_10/21](#)

MOBOTIX AG • Kaiserstrasse • D-67722 Langmeil • Tel.: +49 6302 9816-103 • sales@mobotix.com • www.mobotix.com

MOBOTIX is a trademark of MOBOTIX AG registered in the European Union, the U.S.A., and in other countries. Subject to change without notice. MOBOTIX do not assume any liability for technical or editorial errors or omissions contained herein. All rights reserved. © MOBOTIX AG 2020