

MAKE THE
WORLD SEE

Milestone Systems

XProtect® LPR 2022 R1

Administrator manual



Contents

Copyright, trademarks, and disclaimer	4
Supported VMS products and versions	5
Overview	6
XProtect LPR (explained)	6
XProtect LPR system architecture	6
Compatibility	8
Licensing	9
XProtect LPR licenses	9
Requirements and considerations	10
System requirements	10
Preparing cameras for LPR (explained)	10
Positioning the camera	11
Camera angles	12
Plate width recommendations	13
Image resolution	15
Understanding camera exposure	16
Physical surroundings	20
Lens and shutter speed	21
Contrast	22
Unwanted camera features	23
Installation	24
Install XProtect LPR	24
Configuration	26
View LPR server information	26
LPR server information properties	26
Configuring cameras for LPR	27
Requirements for LPR in the Management Client	27
Snapshots (explained)	28
Add LPR camera	30
Adjust settings for your LPR camera	30

Info tab	30
Recognition settings tab	31
Match lists tab	35
Country modules tab	36
Extend time span for avoiding partial recognitions	39
Select snapshots	39
Validate configuration	40
Auto-configure	41
Working with license plate match lists	41
License plate match lists (explained)	41
Unlisted license plates list (explained)	42
Add new license plate match lists	42
Edit license plate match lists	42
Import/export license plate match lists	43
License plate match list properties	43
Edit custom fields properties	44
Events triggered by LPR	45
Alarms triggered by LPR	45
Alarm definitions for LPR	46
Alarm data settings for LPR	46
Maintenance	48
LPR Server Manager (explained)	48
Start and stop LPR Server service	48
Show LPR server status	48
Show LPR server log	49
Change LPR server settings	49
Upgrade	50
Upgrade XProtect LPR	50
Uninstall XProtect LPR	50

Copyright, trademarks, and disclaimer

Copyright © 2022 Milestone Systems A/S

Trademarks

XProtect is a registered trademark of Milestone Systems A/S.

Microsoft and Windows are registered trademarks of Microsoft Corporation. App Store is a service mark of Apple Inc. Android is a trademark of Google Inc.

All other trademarks mentioned in this document are trademarks of their respective owners.

Disclaimer

This text is intended for general information purposes only, and due care has been taken in its preparation.

Any risk arising from the use of this information rests with the recipient, and nothing herein should be construed as constituting any kind of warranty.

Milestone Systems A/S reserves the right to make adjustments without prior notification.

All names of people and organizations used in the examples in this text are fictitious. Any resemblance to any actual organization or person, living or dead, is purely coincidental and unintended.

This product may make use of third-party software for which specific terms and conditions may apply. When that is the case, you can find more information in the file `3rd_party_software_terms_and_conditions.txt` located in your Milestone system installation folder.

Supported VMS products and versions

This manual describes features supported by the following XProtect VMS products:

- XProtect Corporate
- XProtect Expert
- XProtect Professional+
- XProtect Express+
- XProtect Essential+

Milestone tests the features described in this manual with the above-mentioned XProtect VMS products in the current release version and the two previous release versions.

If new features are only supported by the current release version and not any previous release versions, you can find information about this in the feature descriptions.

You can find the documentation for XProtect clients and add-ons supported by the retired XProtect VMS products mentioned below on the Milestone download page (<https://www.milestonesys.com/downloads/>).

- XProtect Enterprise
- XProtect Professional
- XProtect Express
- XProtect Essential

Overview

XProtect LPR (explained)

Available functionality depends on the system you are using. For more information, see the [product comparison](#) web page.

XProtect LPR offers video-based content analysis (VCA) and recognition of vehicle license plates that interacts with your surveillance system and your XProtect Smart Client.

To read the characters on a plate, XProtect LPR uses optical character recognition on images aided by specialized camera settings.

You can combine LPR (license plate recognition) with other surveillance features such as recording and event-based activation of outputs.

Examples of events in XProtect LPR:

- Trigger surveillance system recordings in a particular quality
- Activate alarms
- Match against positive/negative license plate match lists
- Open gates
- Switch on lights
- Push video of incidents to computer screens of particular security staff members
- Send mobile phone text messages

With an event, you can activate alarms in XProtect Smart Client.

XProtect LPR system architecture

Basic data flow:

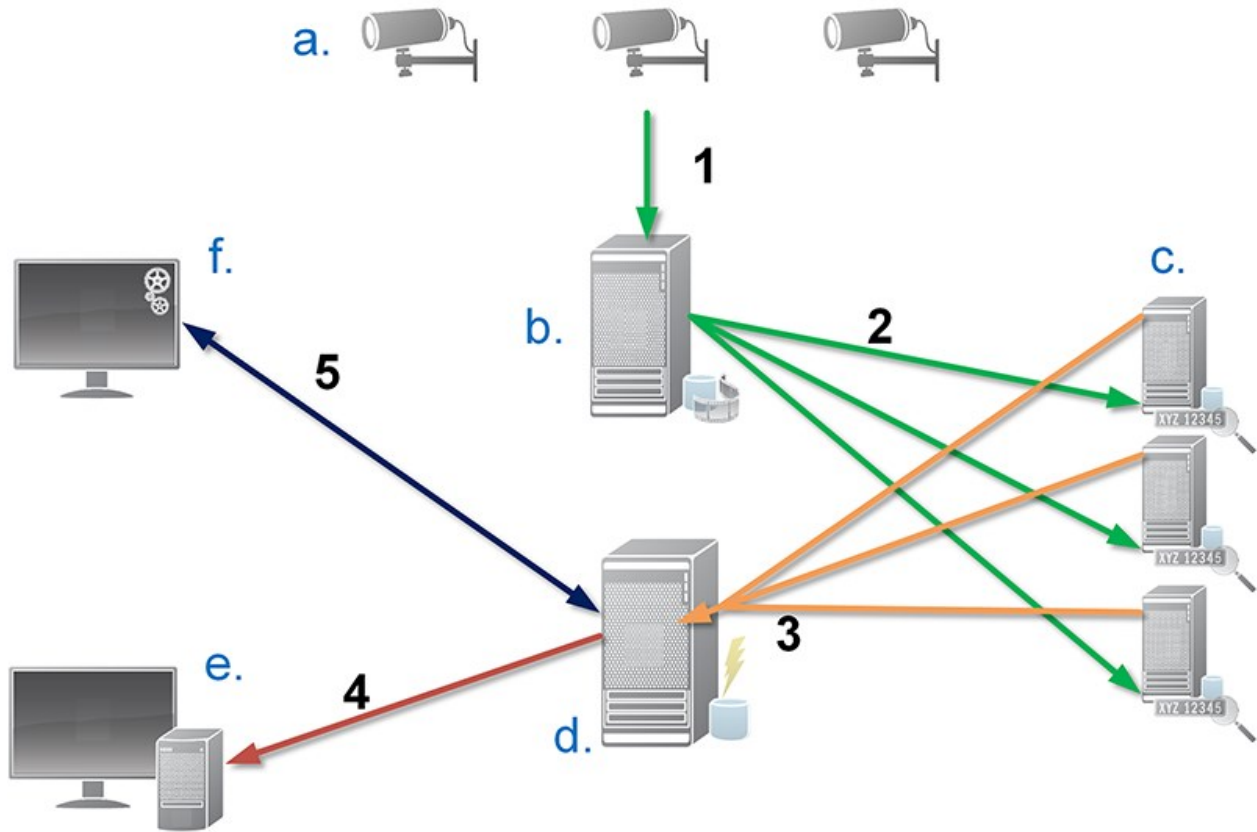

1. LPR cameras (a) send video to the recording server (b).
2. The recording server sends video to the LPR servers (c) to recognize license plates by comparing them with the license plate characteristics in the installed country modules.
3. LPR servers send recognitions to the event server (d) to match with the license plate match lists.
4. The event server sends events and alarms to XProtect Smart Client (e) when there is a match.
5. The system administrator manages the entire LPR configuration, for example, setting up events, alarms, and lists from the Management Client (f).

LPR server: The LPR server handles LPR video recorded by your surveillance system. It analyzes the video and sends information to the event server that uses it for triggering the defined events and alarms. Milestone recommends that you install the LPR server on a computer especially allocated for this purpose.

LPR camera: The LPR camera captures video as any other camera, but some cameras are dedicated for LPR use. The better suited camera you use, the more successful recognitions you will get.

Country module: A country module is a set of rules that defines license plates of a certain type and form as belonging to a certain country or region. It dictates plate and character specifics such as color, height, spacing, and similar, which is used during the recognition process.

License plate match list: A license plate match list is a user-defined list that you create. License plate match lists are collections of license plates that you want your system to treat in a special way. Once you have specified a list, you can set up events to recognize license plates on these lists and in this way trigger events and alarms.

Compatibility

XProtect LPR is compatible with version 2014 SP3 or newer of:

- XProtect Corporate
- XProtect Expert
- Milestone Husky NVRs

XProtect LPR is compatible with version 2017 R2 or newer of:

- XProtect Professional+
- XProtect Express+

Licensing

XProtect LPR licenses

XProtect LPR requires the following LPR-related licenses:

- A **base license** for XProtect LPR that covers an unrestricted number of LPR servers
- One **LPR camera license** per LPR camera you want to use in XProtect LPR
- A **LPR country module license** for each country, state or region you need in your XProtect LPR solution. **Five** LPR country module licenses are included with the XProtect LPR base license. All country modules are automatically installed when you install your XProtect LPR product. However, the installed modules are by default disabled and you must enable the modules (see [Country modules tab on page 36](#)) that you want to use. You can only enable as many country modules as you have LPR country module licenses for

Example: You have five LPR country module licenses and you have installed 10 country modules. Once you have selected five country modules, you cannot select any more. You must clear some of your selections before you can select other modules.

To find information about the current status of your licenses, see [View LPR server information on page 26](#).

To buy additional LPR-related licenses or country modules, contact your vendor.

Requirements and considerations

System requirements

For information about the system requirements for the various components of your system, go to the Milestone website (<https://www.milestonesys.com/systemrequirements/>).



Milestone recommends that you install the LPR server on a computer especially allocated for this purpose.

Preparing cameras for LPR (explained)

LPR differs from other kinds of video surveillance. Normally, you choose cameras based on their ability to provide the best possible images for viewing by the human eye. When you choose cameras for LPR, only the area where you expect to detect license plates is important. The clearer and consistent you capture an image in that small area, the higher recognition rate you will get.

This section helps you prepare cameras for license plate recognition, but it also introduces you to important theories about cameras and lenses that are crucial to understand in order to get optimal images.

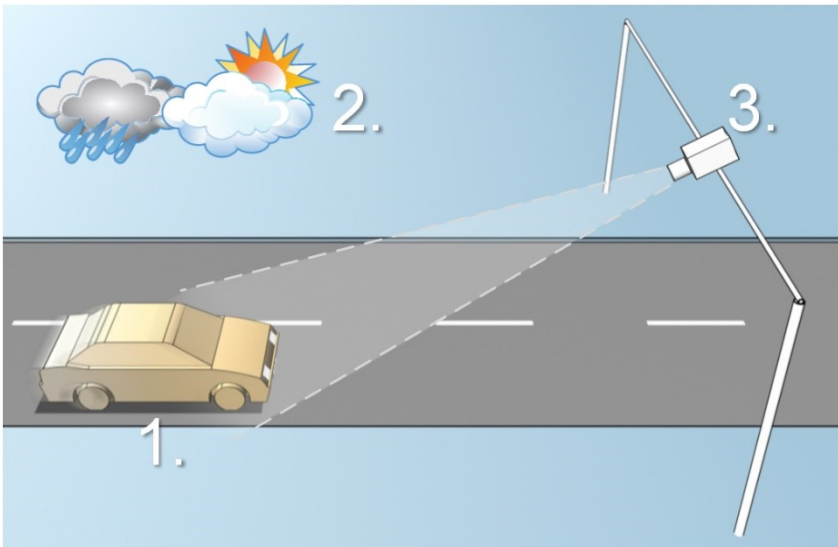

Factors that influence your configuration of LPR:

1. Vehicle	2. Physical surroundings	3. Camera
<ul style="list-style-type: none"> • Speed • Plate size and position 	<ul style="list-style-type: none"> • Lighting conditions • Weather 	<ul style="list-style-type: none"> • Exposure • Field of view • Shutter speed • Resolution • Positioning

It is important to take these factors into consideration as they have a critical influence on successful license plate recognition. You must mount cameras and configure XProtect LPR in a way that matches each specific environment. You cannot expect the product to run successfully without configuration. A camera used for LPR has a CPU consumption that is about five times higher than a normal camera. If a camera has not been set up correctly, it will greatly affect the level of successful recognitions and the CPU performance.

Positioning the camera

When you mount cameras for LPR use, it is important to get a good, clear view of the area of interest so the plate can be detected consistently. This ensures the best possible performance and low risk of false detection:

- The area should cover **only** the part of the image where the license plate is visible as the vehicle moves in and out of the image
- Avoid to have objects that block the view path of the camera, such as pillars, barriers, fences, gates
- Avoid irrelevant moving objects such as people, trees, or traffic in

If too many irrelevant items are included, they will interfere with the detection, and the LPR server will use CPU resources on analyzing irrelevant items instead of license plates.

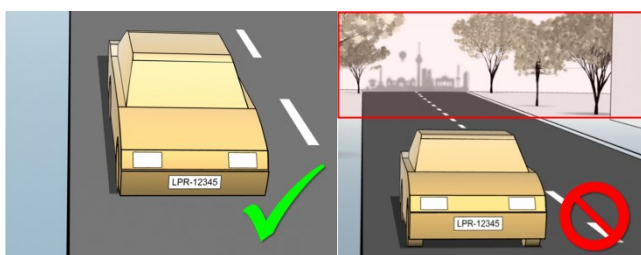

To help you obtain a clear and undisturbed view, you can:

- Mount the camera as close as possible to the area of interest
- Adjust camera angles
- Zoom. If you zoom, always use the camera's optical zoom

Mount the camera so the license plate appears from the top of the image (or bottom if traffic is driving away from the camera) instead of from the right or left side. In this way you make sure that the recognition process of a license plate only starts when the whole plate is in the view:

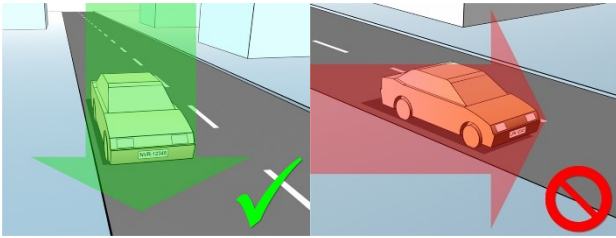

Camera angles

- **Single-line rule:** Mount the camera so that you can draw a horizontal line that crosses both the left and right edge of the license plate in the captured images. See the illustrations below for correct and incorrect angles for recognition.



- **Vertical angle:** The recommended vertical view angle of a camera used for LPR is between 15°-30°.

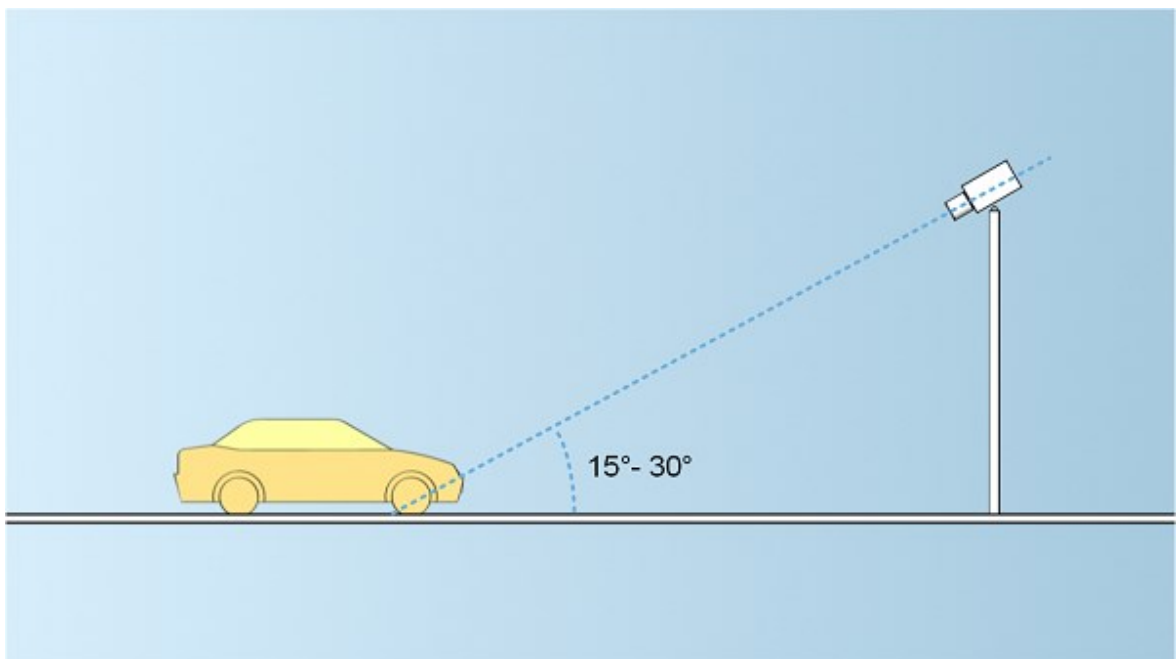

- **Horizontal angle:** The recommended maximum horizontal view angle of a camera used for LPR is between 15°-25°.

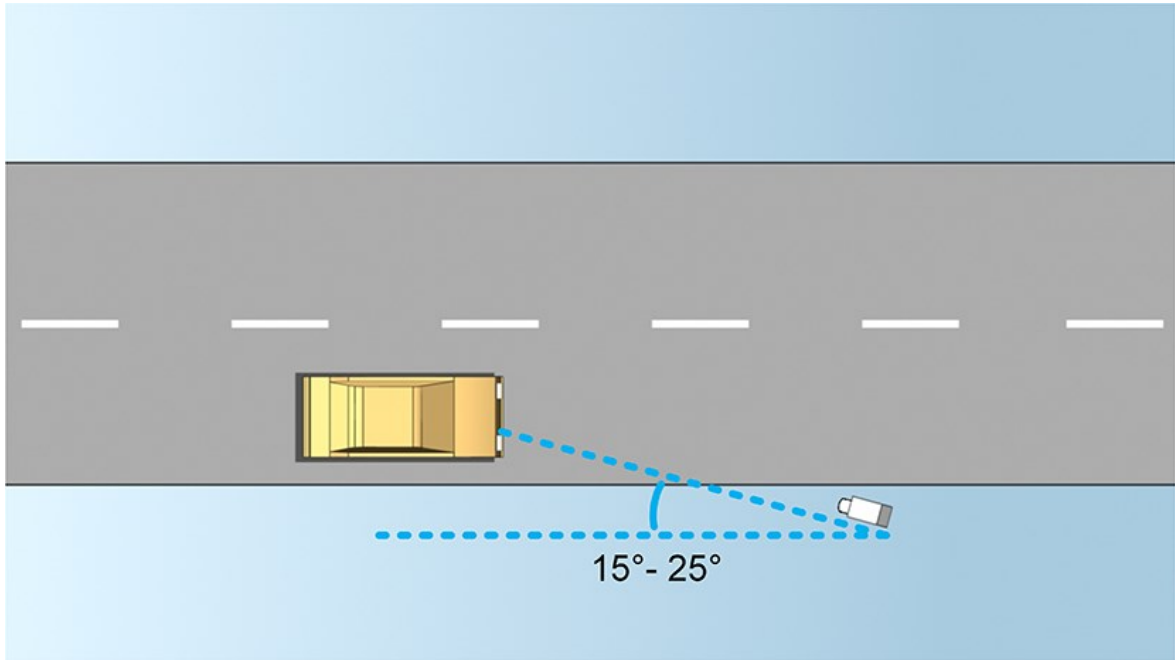
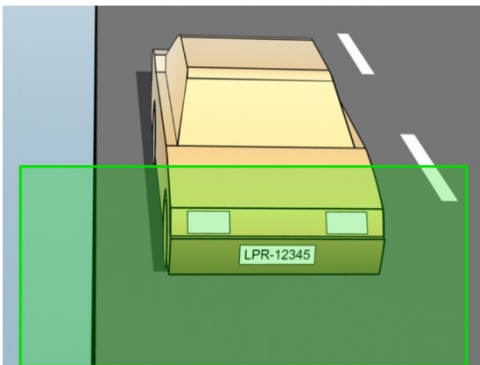

Plate width recommendations

Mount the camera so that the ideal snapshot of the license plate is captured when the license plate is in the center or lower half of the image:



Take a snapshot and make sure that the requirements to stroke width and plate width as described below are fulfilled. Use a standard graphics editor to measure the amount of pixels. When you start the process of reaching the minimum plate width, begin with a low resolution on the camera, and then work your way up in a higher resolution until you have the required plate width.

Stroke width

The term pixels per stroke is used to define a minimum requirement for fonts that should be recognized. The following illustration outlines what is meant by stroke:

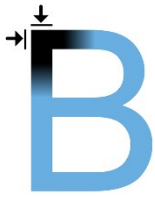

Because the thickness of strokes depends on country and plate style, measurements like pixels/cm or pixels/inch are not used.

The resolution for best LPR performance should be at least 2.7 pixels/stroke.

Plate width

Plate type	Plate width	Setup	Minimum plate width (pixels)
Single line US plates	<ul style="list-style-type: none"> • plate width 12 inches • stroke width around ¼ inches 	vehicles stopped; no interlacing	130
		vehicles are moving; interlaced	215
Single line European plates	<ul style="list-style-type: none"> • plate width 52 cm • stroke width around 1 cm 	vehicles stopped; no interlacing	170
		vehicles are moving; interlaced	280

If vehicles are moving when recorded, and an interlaced camera is used, only a half of the image can be used (only the even lines) for recognition compared with a camera configured for stopped vehicles and no interlacing. This means that the resolution requirements are almost double as high.

Image resolution

Image quality and resolution is important for a successful license plate recognition. On the other hand, if the video resolution is too high, the CPU might be overloaded with the risk of skipped or faulty detections. The lower you can set the acceptable resolution, the better CPU-performance and the higher detection rate you get.

In this example we explain how to do a simple image quality calculation and find a suitable resolution for LPR. The calculation is based on the width of a car.

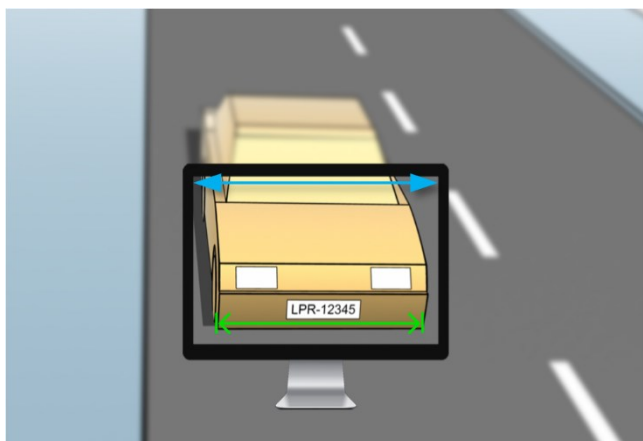

We estimate that the horizontal width is 200 cm/78 inches, as we assume the width of a standard car is 177 cm/70 inches, and besides that we add ~10% for the extra space. You can also do a physical measuring of the area of interest if you need to know the exact width.

The recommended resolution of the stroke thickness is 2.7 pixels/stroke, and the physical stroke thickness is 1 cm for a European plate and 0.27 inches for a US plate. This gives the following calculation:

Calculation for European plates in cm:

$$200 \times 2.7 \div 1 = 540 \text{ pixels}$$

Recommended resolution = VGA (640×480)

Calculation for US plates in inches:

$$78 \times 2.7 \div 0.27 = 780 \text{ pixels}$$

Recommended resolution = SVGA (800×600)



Because US plates use a font with a narrow stroke, a higher resolution is needed than for European plates.

Common video resolutions

Name	Pixels (W×H)
QCIF	176×120
CIF	352×240
2CIF	704×240
VGA	640×480
4CIF	704×480
D1	720×576
SVGA	800×600
XGA	1024×768
720p	1280×1024

Understanding camera exposure

Camera exposure determines how light/dark and sharp/blurry an image appears when it has been captured. This is determined by three camera settings: aperture, shutter speed, and ISO speed. Understanding their use and interdependency can help you to set up the camera correctly for LPR.

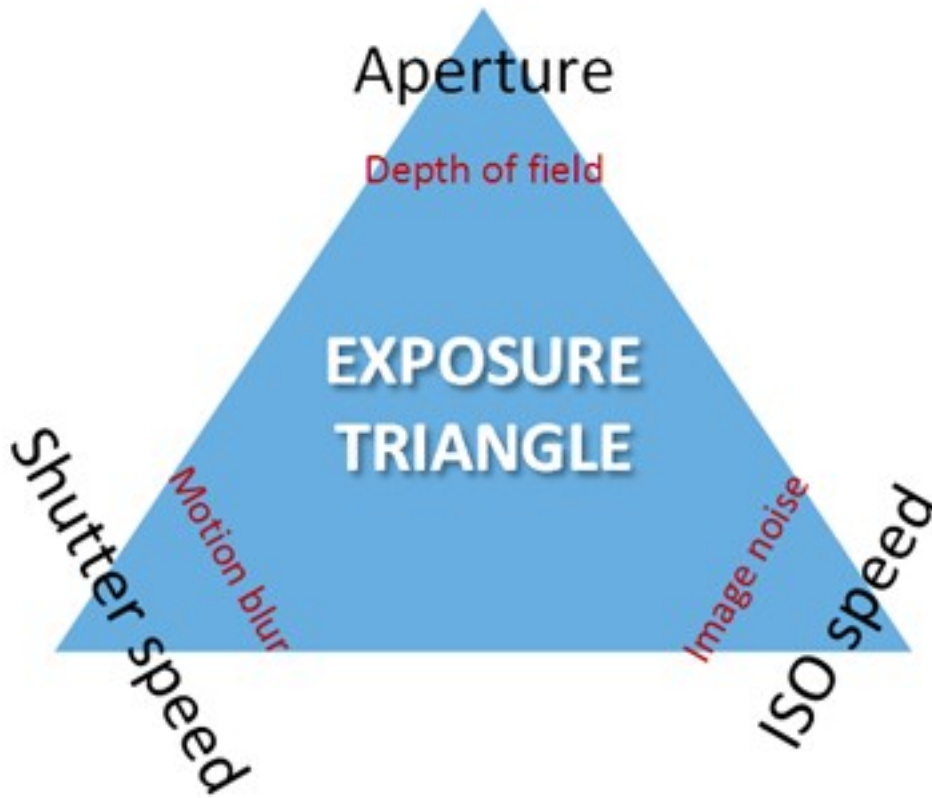

You can use different combinations of the three settings to achieve the same exposure. The key is to know which trade-offs to make, since each setting also influences the other image settings:

Camera settings	Controls...	Affects...
Aperture	The adjustable opening that limits the amount of light to enter the camera	Depth of field
Shutter speed	The duration of the exposure	Motion blur
ISO speed	The sensitivity of the camera's sensor to a given amount of light	Image noise

The next sections describe how each setting is specified, what it looks like, and how a given camera exposure mode affects this combination:

Aperture settings

The aperture setting controls the amount of light that enters your camera from the lens. It is specified in terms of an f-stop value, which can at times be counterintuitive, because the area of the opening increases as the f-stop decreases.

Low f-stop value/wide aperture = shallow depth of field

High f-stop value/narrow aperture = large depth of field

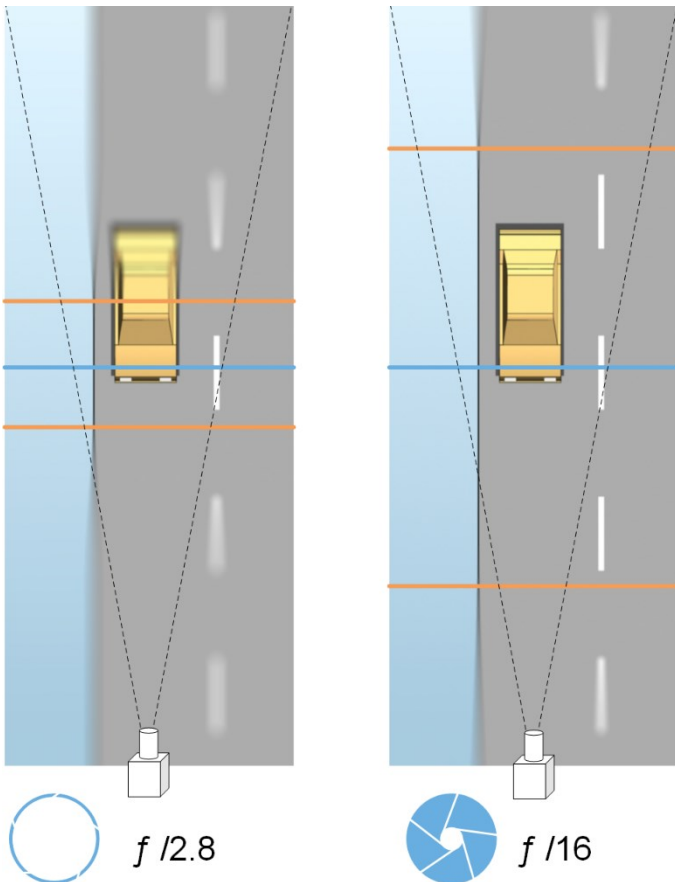
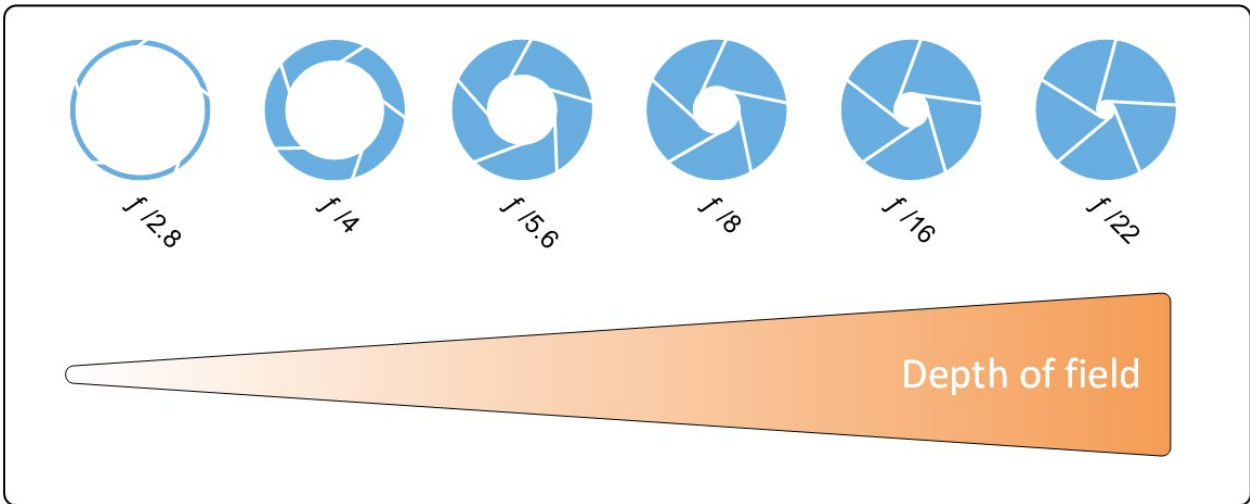

The example illustrates how the depth of field is affected by the f-stop value. The blue line indicates the focus point.

A high f-stop value makes it possible to have a longer distance where the license plate is in focus. Good light conditions are important for sufficient exposure. If lighting conditions are insufficient, the exposure time needs to be longer, which again increases the risk of getting blurry images.

A low f-stop value reduces the focus area and thereby the area used for recognition, but is suitable for conditions with low light. If it is possible to ensure that vehicles are passing the focus area at a low speed, a low f-stop value is suitable for a consistent recognition.

Shutter speed

A camera's shutter determines when the camera sensor is open or closed for incoming light from the camera lens. The shutter speed refers to the duration when the shutter is open and light can enter the camera. Shutter speed and exposure time refer to the same concept, and a faster shutter speed means a shorter exposure time.

Motion blur is undesired for license plate recognition and surveillance. In many occasions vehicles are in motion while license plates are detected which makes a correct shutter speed an important factor. The rule of thumb is to keep the shutter speed high enough to avoid motion blur, but not too high as this may cause under-exposed images depending on light and aperture.

ISO speed

The ISO speed determines how sensitive the camera is to incoming light. Similar to shutter speed, it also correlates 1:1 with how much the exposure increases or decreases. However, unlike aperture and shutter speed, a lower ISO speed is in general desirable, since higher ISO speeds dramatically increase image noise. As a result, ISO speed is usually only increased from its minimum value if the desired image quality is not obtainable by modifying the aperture and shutter speed settings solely.

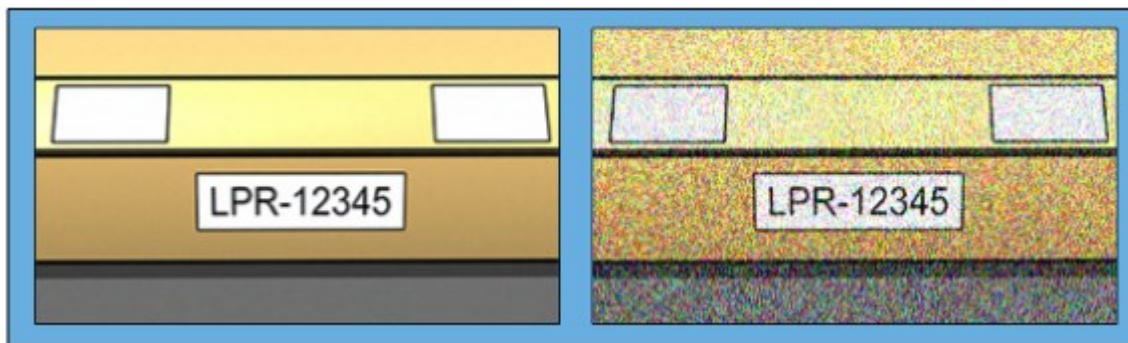

Low ISO speed image vs High ISO speed image

Common ISO speeds include 100, 200, 400 and 800, although many cameras also permit lower or higher values. With digital single-lens reflex (DSLR) cameras, a range of 50-800 (or higher) is often acceptable.

Physical surroundings

When you mount and use cameras for LPR, note the following factors related to the surroundings:

- **Much light:** Too much light in the surroundings can lead to overexposure or smear:
 - **Overexposure** is when images are exposed to too much light, resulting in a burnt-out and overly white appearance. To avoid overexposure, Milestone recommends that you use a camera with a high dynamic range and/or use an auto-iris lens. **Iris** is the adjustable aperture. For that reason, iris has a significant effect on the exposure of images
 - **Smear** is an effect from overexposure that leads to unwanted light vertical lines in images. It is often caused by slight imperfections in the cameras' charge-coupled device (CCD) imagers. The CCS imagers are the sensors used to digitally create the images



- **Little light:** Too little light in the surroundings or too little external lighting can lead to underexposure:
 - **Underexposure** is when images are exposed to too little light, resulting in a dark image with hardly any contrast (see [Contrast on page 22](#)). When auto-gain (see [Unwanted camera features on page 23](#)) cannot be disabled or when you are not able to configure a maximum allowed shutter time (see [Lens and shutter speed on page 21](#)) for capturing moving vehicles, too little light will initially lead to gain noise and motion blur in the images, and ultimately to underexposure. To avoid underexposure, use sufficient external lighting and/or use a camera that has sufficient sensitivity in low-light surroundings without using gain
 - **Infrared:** Another way to overcome difficult lighting conditions is to use artificial infrared lighting combined with an infrared-sensitive camera with an infrared pass filter. Retro-reflective license plates are particularly suitable for use with infrared lighting:
 - **Retro-reflectivity** is achieved by covering surfaces with a special reflective material which sends a large portion of the light from a light source straight back along the path it came from. Retro-reflective objects appear to shine much more brightly than other objects. This means that at night they can be seen clearly from considerable distances. Retro-reflectivity is frequently used for road signs, and is also used for different types of license plates

- **Weather:** Snow or very bright sunlight may for example require special configuration of cameras
- **Plate condition:** Vehicles may have damaged or dirty license plates. Sometimes this is done deliberately in an attempt to avoid recognition

Lens and shutter speed

When configuring cameras' lenses and shutter speeds for LPR, note the following:

- **Focus:** Always make sure the license plate is in focus
- **Auto-iris:** If using an auto-iris lens, always set the focus with the aperture as open as possible. In order to make the aperture open, you can use neutral density (ND) filters or—if the camera supports manual configuration of the shutter time—the shutter time can be set to a very short time
 - **Neutral Density (ND) filters** or gray filters basically reduce the amount of light coming into a camera. They work as "sunglasses" for the camera. ND filters affect the exposure of images (see [Understanding camera exposure on page 16](#))
- **Infrared:** If using an infrared light source, focus may change when switching between visible light and infrared light. You can avoid the change in focus by using an infrared compensated lens, or by using an infrared pass filter. If you use an infrared pass filter, an infrared light source is required—also during daytime
- **Vehicle speed:** When vehicles are moving, cameras' shutter time should be short enough to avoid motion blur. A formula for calculating the longest suitable shutter time is:
 - **Vehicle speed in km/h:** Shutter time in seconds = 1 second / (11 × max vehicle speed in kilometers per hour)
 - **Vehicle speed in mph:** Shutter time in seconds = 1 second / (18 × max vehicle speed in miles per hour)

where / denotes "divided by" and × denotes "multiplied by."

The following table provides guidelines for recommended camera shutter speeds for different vehicle speeds:

Shutter time in seconds	Max. vehicle speed in kilometers per hour	Max. vehicle speed in miles per hour
1/50	4	2
1/100	9	5
1/200	18	11

Shutter time in seconds	Max. vehicle speed in kilometers per hour	Max. vehicle speed in miles per hour
1/250	22	13
1/500	45	27
1/750	68	41
1/1000	90	55
1/1500	136	83
1/2000	181	111
1/3000	272	166
1/4000	363	222

Contrast

When you determine the right contrast for your LPR camera, consider the difference in gray value (when images are converted to 8-bit grayscale) between the license plate’s characters and the license plate’s background color:

Good contrast	Acceptable contrast; recognition is still possible
	

Pixels in an 8-bit grayscale image can have color values ranging from 0 to 255, where grayscale value 0 is absolute black and 255 is absolute white. When you convert your input image to an 8-bit grayscale image, the minimum pixel value difference between a pixel in the text and a pixel in the background should be at least 15.

Noise in the image (see [Unwanted camera features on page 23](#)), the use of compression (see [Unwanted camera features on page 23](#)), the light conditions, and similar can make it difficult to determine the colors of a license plate’s characters and background.

Unwanted camera features

When you configure cameras for LPR, note the following:

Automatic gain adjustment: One of the most common types of image interference caused by cameras is gain noise.

- **Gain** is basically the way that a camera captures a picture of a scene and distributes light into it. If light is not distributed optimally in the image, the result is gain noise.



Controlling gain requires that complex algorithms are applied, and many cameras have features for automatically adjusting gain. Unfortunately, such features are rarely helpful in connection with LPR. Milestone recommends that you configure your cameras' auto-gain functionality to be as low as possible. Alternatively, disable the cameras' auto-gain functionality.

In dark surroundings, you can avoid gain noise by installing sufficient external lighting.

Automatic enhancement: Some cameras use contour, edge or contrast enhancement algorithms to make images look better to the human eye. Such algorithms can interfere with the algorithms used in the LPR process. Milestone recommends that you disable the cameras' contour, edge and contrast enhancement algorithms whenever possible.

Automatic compression: High compression rates can have a negative influence on the quality of license plate images. When a high compression rate is used, more resolution (see [Plate width recommendations on page 13](#)) is required in order to achieve optimal LPR performance. If a low JPEG compression is used, the negative impact on LPR is very low, as long as the images are saved with a JPEG quality level of 80% or above, and images have normal resolution, contrast and focus as well as a low noise level.

Acceptable	Unacceptable
	
<p>License plate image saved with a JPEG quality level of 80% (i.e. low compression).</p>	<p>License plate image saved with a JPEG quality level of 50% (i.e. high compression).</p>

Installation

Install XProtect LPR

To run XProtect LPR, you must install:

- At least one LPR server
- The XProtect LPR plug-in on all computers that run the Management Client and the event server
- Make sure that the user selected for running the LPR Server service can access the management server



Milestone recommends that you install the LPR server on a different computer than your management server or recording servers.



If you install the LPR server on a different computer, you must add the computer to the **Administrators** role as a **Windows user**.

Start installation:

1. Go to the download page on the Milestone website (<https://www.milestonesys.com/downloads/>).
2. Download the two installers:
 - *Milestone XProtect LPR Plug-in* installer to all computers that run the Management Client and the event server
 - *Milestone XProtect LPR Server* installer to all computers allocated for this purpose. You can also create virtual servers for LPR on one computer
3. First, run all the *Milestone XProtect LPR Plug-in* installers.

4. Then, run the *Milestone XProtect LPR Server* installer(s).

During installation:

1. Specify the IP address or host name of the management server or image server including the domain user name and password of a user account that has administrator rights to the surveillance system.
2. For secure communication:
 - Select the certificate used to connect to the management server
 - Select the certificate used to connect to the event server

For more information, see the [certificates guide about how to secure your XProtect VMS installations](#).

3. Select the service account. If the computer is part of a domain, the service must run as either a predefined Network Service or a domain user account.
5. Launch the Management Client.

In the **Site Navigation pane**, your Management Client automatically lists the installed LPR servers in the **LPR Servers** list.

6. Make sure that you have the necessary licenses (see [XProtect LPR licenses on page 9](#)).
7. All country modules are automatically installed when you install your XProtect LPR product. However, the installed modules are by default disabled and you must enable the modules (see [Country modules tab on page 36](#)) that you want to use. You can only enable as many country modules as you have LPR country module licenses for.

You cannot add LPR servers from the Management Client.

If you need to install more LPR servers after the initial installation, run the *Milestone XProtect LPR Server* installer on these computers.



If an antivirus program is installed on a computer running XProtect software, it is important that you exclude the C:\ProgramData\Milestone\XProtect LPR folder. Without implementing this exception, virus scanning uses a considerable amount of system resources and the scanning process can temporarily lock files.

Configuration

View LPR server information

To check the state of your LPR servers:

1. In the **Site Navigation pane**, expand **Servers** and select **LPR servers**. Go to the Overview pane.

The **LPR server information** window opens with a summary of the server status:

- Name
- Host name
- Status

2. Select the relevant LPR server and review all details for this server.

LPR server information properties

Field	Description
Name	Here you can change the name of the LPR server.
Host name	Shows the LPR server host name. The first part of the name of the LPR server consists of the name of the host computer for your LPR server installation. Example: MYHOST.domainname.country.
Status	Shows the status of the LPR server. If the server has just been added, the status is: <ul style="list-style-type: none"> • No LPR cameras configured If the system is running without problems, the status is: <ul style="list-style-type: none"> • All LPR cameras are running Alternatively, the system returns: <ul style="list-style-type: none"> • Service not responding • Not connected to surveillance system • Service not running

Field	Description
	<ul style="list-style-type: none"> • Event Server not connected • Unknown error • X of Y LPR cameras running
Service up time	Shows the up time since the LPR server was last down and the LPR Server service started.
Computer CPU usage	Shows the current CPU usage on the entire computer with the LPR server(s) installed.
Memory available	Shows how much memory is available on the LPR server.
Recognized license plates	Shows the number of license plates that the LPR server has recognized in this session.
LPR cameras	Shows a list of enabled LPR cameras that run on the LPR server and their status.
LPR cameras available	Based on your license, this number shows how many additional LPR cameras you are allowed to add and use on all your LPR servers in total.
Country modules available	Based on your license, this number shows how many additional country modules you are allowed to use on all your LPR servers in total. It also lists the number of country modules already in use.

Configuring cameras for LPR

This article describes the steps to go through when you add and configure cameras used with XProtect LPR.

Requirements for LPR in the Management Client

Once cameras have been mounted and added in the Management Client, adjust each camera's settings so that they match the requirements for LPR. You adjust camera settings on the properties tabs for each camera device.

For the relevant cameras, Milestone recommends to:

- Set the video codec to JPEG



If you use H.264 or H.265 codec, only key frames are supported. This is usually only one frame per second which is not enough for LPR. For higher frame rates, always use a JPEG codec.

- Specify a frame rate of four frames per second
- Avoid compression, so set a fine quality
- If possible, specify a resolution below one megapixel
- If possible, keep automatic sharpness at a low level

To learn about LPR fundamentals, make yourself familiar with the information in [Preparing cameras for LPR \(explained\) on page 10](#).

Snapshots (explained)

The system uses snapshots to optimize the configuration automatically and to visualize the effect of the recognition settings as they are applied.

You need to provide at least one valid snapshot in order to complete the initial configuration of a camera.

As a guideline, capture snapshots of vehicles in the real physical surroundings and conditions, in which you want to be able to recognize license plates.

The list below illustrates examples of the situations that you should consider when you capture and select snapshots. Not all may be applicable to your surroundings.

Milestone recommends that you select minimum 5-10 snapshots that represent typical conditions of:

The weather; for example, sunlight and rain

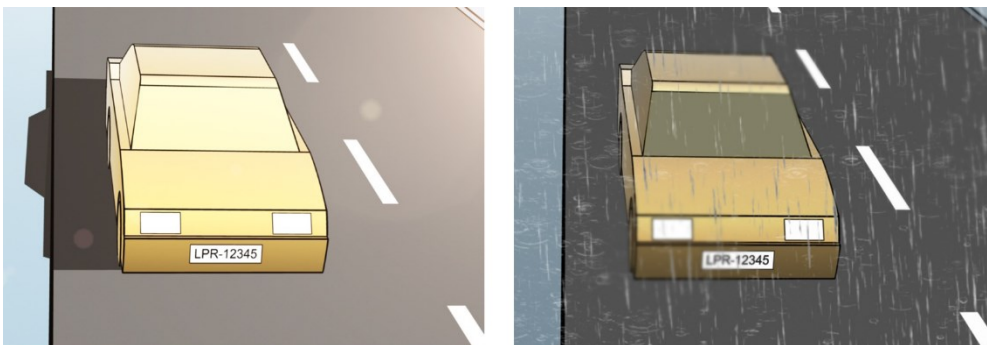

The light; for example, daylight and nighttime

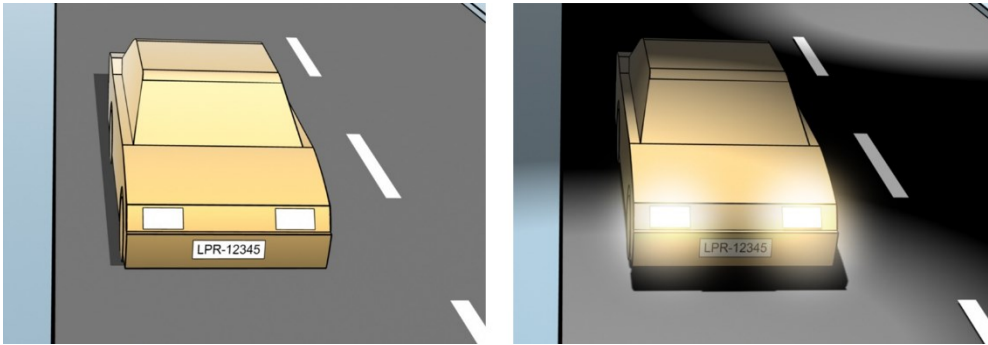

Vehicle types; to define the top and bottom of the recognition area

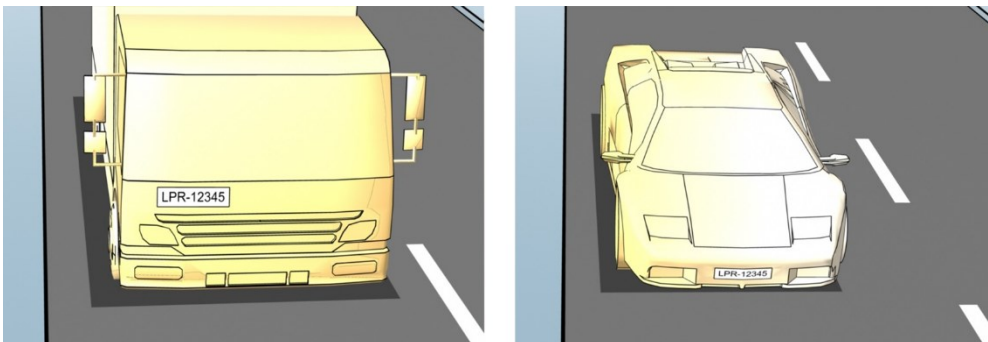

Position in the lane; to define the left and right of the recognition area

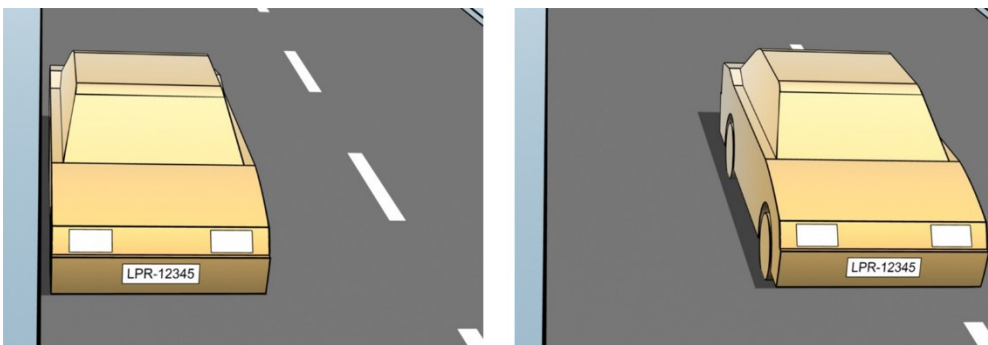

Distance to the car; to define the area where LPR analyzes license plates

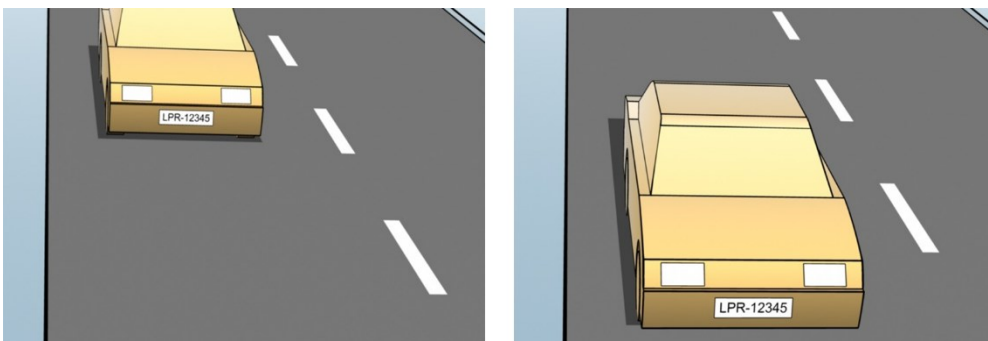

Add LPR camera

To configure cameras for LPR, you initially run the **Add LPR camera** wizard. The wizard takes you through the main configuration steps and automatically optimizes the configuration.

To run the wizard:

1. In the **Site Navigation pane**, expand **Servers**, expand **LPR servers**, and select **LPR camera**.
2. Go to the Overview pane. Right-click **LPR camera**.
3. From the menu that appears, select **Add LPR camera** and follow the instructions in the wizard:
 - Select the camera you want to configure for LPR
 - Select which country modules you want to use with your LPR camera (see [Country modules tab on page 36](#))
 - Select snapshots to use for validating the configuration (see [Snapshots \(explained\) on page 28](#))
 - Validate the result of the snapshot analysis (see [Validate configuration on page 40](#))
 - Select which license plate match lists to use (see [License plate match lists \(explained\) on page 41](#)). Choose the default selection, if you have not yet created any lists
4. On the last page, click **Close**.

The LPR camera appears in the Management Client and based on your selections, the system has optimized the recognition settings for the camera (see [Add LPR camera on page 30](#)).

5. Select the camera you have added and review its settings. You only need to change the configuration if the system does not recognize license plates as well as expected.
6. In the **Recognition settings** tab, click **Validate configuration** (see [Validate configuration on page 40](#)).

Adjust settings for your LPR camera

The system automatically optimized the configuration of your LPR camera, when you added the LPR camera with the **Add LPR camera** wizard. If you want to make changes to the initial configuration, you can:

- Change the name of the server or change server (see [Info tab on page 30](#))
- Adjust and validate the recognition settings (see [Recognition settings tab on page 31](#))
- Add more license plate match lists (see [Match lists tab on page 35](#))
- Enable additional country modules (see [Country modules tab on page 36](#))

Info tab

This tab provides information about the selected camera:

Name	Description
Enable	LPR cameras are by default enabled after the initial configuration. Disable any camera that is not used in connection with LPR. Disabling an LPR camera does not stop it from performing normal recording in the surveillance system.
Camera	Shows the name of the selected camera as it appears in the XProtect Management Client and the clients.
Description	Use this field to enter a description (optional).
Change Server	Click to change LPR server. Changing the LPR server can be a good idea if you need to load balance. For example, if the CPU load is too high on an LPR server, Milestone recommends that you move one or more LPR cameras to another LPR server.

Recognition settings tab

Change recognition settings manually. Based on the snapshots you provided, the system auto-configured the recognition settings. Changing these settings can greatly affect the recognition success rate.

Action buttons

Change, update, and validate auto-configured settings.

Name	Description
Validate configuration	Test that license plates are recognized as expected (see Validate configuration on page 40).
Auto-configure	Discard manual changes and auto-configure settings (see Auto-configure on page 41).
Snapshots	Add or delete snapshots (see Select snapshots on page 39).

Recognition area

To ensure best performance and avoid false recognitions, Milestone recommends that you select a clearly defined and "well-trimmed" recognition area. The area should cover only the part of the image where the license plate is visible and remains visible as the vehicle moves in and out of the image. Avoid irrelevant moving objects (people, trees, traffic) in the recognition area (see [Positioning the camera on page 11](#)).

License plates are not recognized in the red area.



When specifying a recognition area, you can click:

- **Clear** to remove all selections and select new areas for LPR
- **Undo** to revert to your last saved recognition area

After changing the settings for your LPR camera, validate your configuration (see [Validate configuration on page 40](#)) to check if the system recognizes license plates as well as expected.

Character height

Define the minimum and maximum height of the license plate characters (in percent). Select character heights as close as possible to the height of the characters in the real license plate.

These character settings affect the recognition time and process. The smaller the difference between the minimum and the maximum character height:

- The smoother the LPR process
- The lower the CPU load
- The sooner you get the results

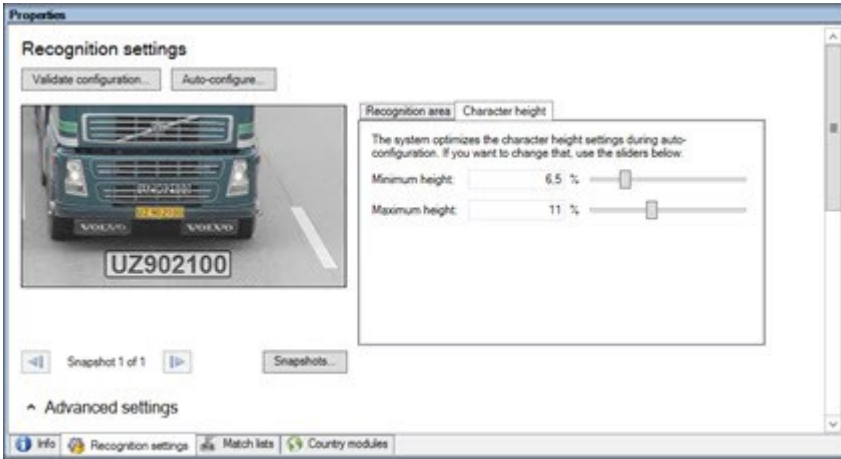

The overlay in the snapshot displays the currently defined character height setting. The overlay grows and shrinks proportionally to the character height settings to the right. For easy comparison, drag the overlay on top of the real license plate in the snapshot. Zoom with your mouse wheel for a closer look.

Name	Description
Minimum height	Set the minimum character height for including license plates in the recognition process. If the real license plate characters are smaller than the value you specify, the system will not start the recognition process.
Maximum height	Set the maximum character height for including license plates in the recognition process. If the real license plate characters are bigger than the value you specify, the system will not start the recognition process.

After changing the settings for your LPR camera, validate your configuration (see [Validate configuration on page 40](#)) to check if the system recognizes license plates as well as expected.

Advanced settings

The recognition process has two steps: 1) finding the plate(s) and 2) recognizing the characters in the plates. Click **Advanced settings** to define a trade-off between processing speed and recognition quality.

High recognition quality:

- Needs higher computational effort
- Increases CPU load
- Takes more time to return results

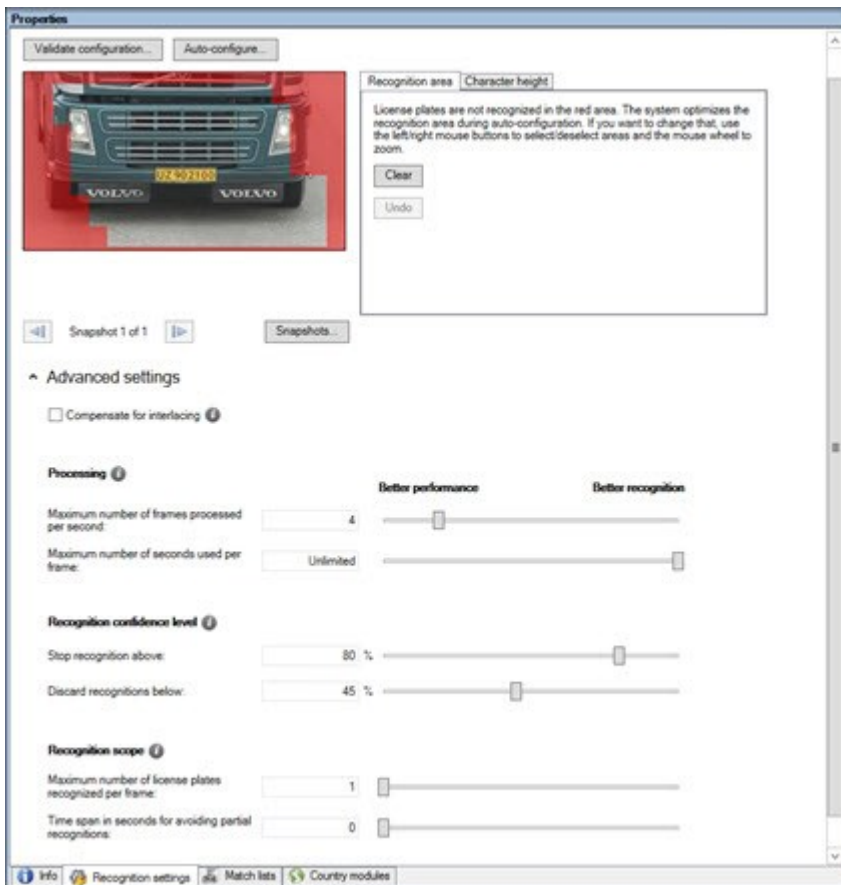

When the optimal results are met, the recognition process stops and returns the license plate it recognized at that point.

Name	Description
Compensate for interlacing	If your LPR camera records interlaced video, and you see a combing effect in the de-interlaced image in LPR, select this check box. This may improve image quality and recognition results.
Maximum number of frames processed per second	Limit the number of frames your system processes every second. If you keep this setting low, you can increase the frame rate on your camera without adding unnecessary load to your LPR server. Unrestricted: Remove the top limit. You will risk increasing the processing time and the CPU load.
Maximum	Limit the number of seconds your LPR can spend on recognizing one frame. If

Name	Description
number of seconds used per frame	adjusted, the recommended value is 0.2 seconds per frame. Unlimited: Remove the top limit. You will risk increasing the processing time and the CPU load.
Stop recognition above	Stop recognition when a license plate is recognized with a confidence level equal to or above the value you specify.
Discard recognitions below	Discard recognitions with a confidence level below the value you specify. Increase this value to get fewer but possibly more accurate recognitions. Decrease this value to get more but potentially less accurate recognitions. The smaller the difference between Stop recognition above and Discard recognitions below values, the lower the processing time and the CPU load.
Maximum number of license plates recognized per frame	Recognize several license plates simultaneously. For example, relevant for cameras recording multi-lane roads, where many license plates must be recognized at the same time. Unrestricted: Remove the top limit. You will risk increasing the processing time and the CPU load.
Time span in seconds for avoiding partial recognitions	Delay all recognitions for the time period you specify. This is to avoid that the same license plate is recognized several times as different license plates. The system will wait for a better recognition and only accept the most complete recognition. <div style="background-color: #e6f2ff; padding: 10px; border: 1px solid #0070c0;">  <p>Before changing this setting, ensure no irrelevant moving objects (see Camera angles on page 12) block the view of your LPR camera.</p> </div>

After changing the settings for your LPR camera, validate your configuration (see [Validate configuration on page 40](#)) to check if the system recognizes license plates as well as expected.

Match lists tab

On this tab you select which license plate match list(s) you want a specific LPR camera to match license plates against. You can create as many lists as you need (see [Add new license plate match lists on page 42](#)).

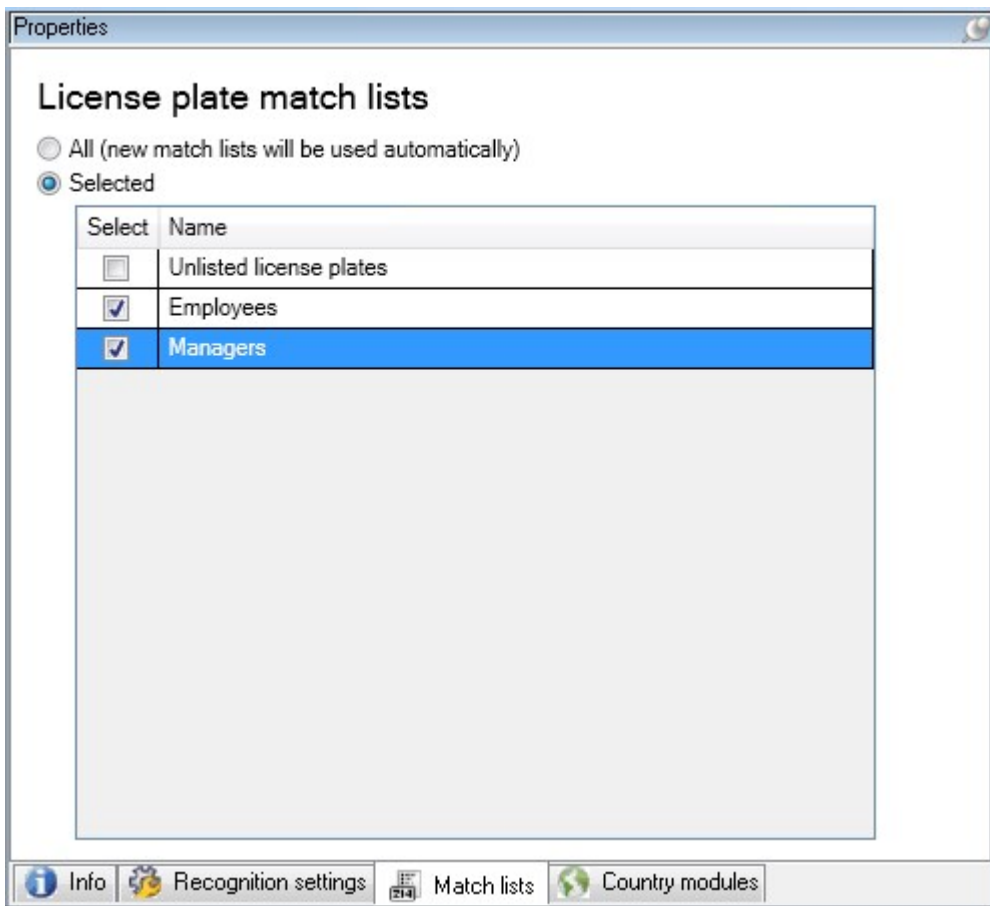

Name	Description
All	License plates are matched against all available and future lists.
Selected	License plates are matched against the selected lists only. Select one or more from the available lists.

After changing the settings for your LPR camera, validate your configuration (see [Validate configuration on page 40](#)) to check if the system recognizes license plates as well as expected.

Country modules tab

Here you select the country modules that you want to use with a specific LPR camera. The list that you can select from, depends on which modules you have installed and your licenses (see [XProtect LPR licenses on page 9](#)).



Milestone recommends that you select maximum 5 country modules per camera.

A country module is a set of rules that defines license plates of a certain type and form belonging to a certain country, state or region.

Already licensed modules appear with a check mark in the **Licensed** column. If the country module you are looking for is not on your list, contact your vendor.

LPR camera Information

Country modules

Search by country module or country code

Select	Country module	Country code	Licensed
<input type="checkbox"/>	Burkina Faso	BF	<input type="checkbox"/>
<input type="checkbox"/>	Burundi	BU	<input type="checkbox"/>
<input type="checkbox"/>	Cameroon	CMR	<input type="checkbox"/>
<input type="checkbox"/>	Canada	CDN	<input type="checkbox"/>
<input type="checkbox"/>	Canada - Alberta	CDN_AB	<input type="checkbox"/>
<input type="checkbox"/>	Canada - British Columbia	CDN_BC	<input type="checkbox"/>
<input type="checkbox"/>	Canada - Manitoba	CDN_MB	<input type="checkbox"/>
<input type="checkbox"/>	Canada - Ontario	CDN_ON	<input type="checkbox"/>
<input type="checkbox"/>	Canada - Quebec	CDN_QC	<input type="checkbox"/>
<input type="checkbox"/>	Chile	RCH	<input type="checkbox"/>
<input type="checkbox"/>	China	CN	<input type="checkbox"/>
<input type="checkbox"/>	Colombia	CO	<input type="checkbox"/>
<input type="checkbox"/>	Congo	CGO	<input type="checkbox"/>
<input type="checkbox"/>	Croatia	HR	<input type="checkbox"/>
<input type="checkbox"/>	Cyprus	CY	<input type="checkbox"/>
<input type="checkbox"/>	Czech Republic	CZ	<input type="checkbox"/>
<input type="checkbox"/>	Dangerous Goods	X_DG	<input type="checkbox"/>
<input type="checkbox"/>	Democratic Republic of Congo	RCB	<input type="checkbox"/>
<input checked="" type="checkbox"/>	Denmark	DK	<input checked="" type="checkbox"/>
<input type="checkbox"/>	Dominican Republic	DOM	<input type="checkbox"/>
<input type="checkbox"/>	Ecuador	EC	<input type="checkbox"/>
<input type="checkbox"/>	Egypt	ET	<input type="checkbox"/>
<input type="checkbox"/>	Estonia	EST	<input type="checkbox"/>
<input type="checkbox"/>	EU	X_EU	<input type="checkbox"/>
<input checked="" type="checkbox"/>	EU Generic	EU	<input checked="" type="checkbox"/>
<input type="checkbox"/>	Faroe Islands	FO	<input type="checkbox"/>
<input type="checkbox"/>	Finland	FIN	<input type="checkbox"/>
<input type="checkbox"/>	France	F	<input type="checkbox"/>
<input type="checkbox"/>	Generic	X_XX	<input type="checkbox"/>
<input type="checkbox"/>	Generic number reader	X_NR	<input type="checkbox"/>
<input type="checkbox"/>	Georgia	GE	<input type="checkbox"/>

7 free country module license(s) available.

Selected country modules:
Denmark (DK)
EU Generic (EU)

Info Recognition settings Match lists Country modules

Name	Description
Select	Click to select or deselect a country module. The list of selected country modules on the right-hand side updates automatically.
Country Module	Lists the installed country modules.
Country Code	Letters that identify a country module.
Licensed	Shows if a country module is already licensed. You can select a licensed country module for as many cameras as you like.

After changing the settings for your LPR camera, validate your configuration (see [Validate configuration on page 40](#)) to check if the system recognizes license plates as well as expected.

Extend time span for avoiding partial recognitions

If parts of the same license plate are recognized as separate and incomplete plate numbers, ensure no irrelevant moving objects (see [Camera angles on page 12](#)) block the view of your LPR camera. If the problem persists, give the system more time to avoid partial recognitions. Your recognitions will be more accurate, but they will all show up delayed.

1. In the **Site Navigation** pane, expand **Servers**.
2. Expand **LPR servers** and click **LPR cameras**.
3. In the **LPR cameras** pane, find and click the camera to modify.
4. On the **Recognition settings** tab, click **Advanced settings**.
5. In the **Time span for avoiding partial recognitions** field, drag the slider to the right to give the system a maximum of five extra seconds to recognize the most complete license plate numbers and discard the rest.

Select snapshots

When you configured the LPR initially with the **Add LPR camera** wizard, you also added snapshots (see [Snapshots \(explained\) on page 28](#)). You can always add additional representative snapshots to improve the optimization of the configuration.

1. Select the relevant camera.
2. In the **Recognition settings** tab, click **Snapshots**.
3. Capture snapshots from live video or import them from an external location. Click **Next**.

The system analyzes the snapshots you have selected for the camera.

4. On the next page, approve or reject each of the snapshots. If the system could not recognize any license plates, click **Previous** to add new snapshots in a better quality. If the system still cannot provide correct recognitions, you probably need to change your configuration. Check that the camera is mounted and configured correctly (see [Preparing cameras for LPR \(explained\) on page 10](#)).
5. When you have approved all snapshots, click **Next** and close the wizard.
6. On the **Recognition settings** tab, click **Validate configuration** (see [Validate configuration on page 40](#)).

Validate configuration

You can validate your current configuration to see if you need to change any settings or provide more snapshots. The validation function informs you about how many license plates your system recognizes, and if they are recognized correctly.

It can help you decide if your confidence level is set correctly and if your system configuration is optimal.

1. Select the relevant camera.
2. From the **Recognition settings** tab, click **Validate configuration**.

Based on the current settings, the system analyzes the snapshots you have selected for the camera and provides a result summary:

- **License plates detected:** The number of recognized license plates, for example, 3 of 3
- **Average confidence:** The average percent of confidence with which the license plates have been recognized
- **Average processing time:** The average time it took to analyze a snapshot and return a reading measured in ms

License plates detected:	2 of 2
Average confidence:	91 %
Average processing time:	112 ms

3. If the current configuration meets your requirements, click **Close**.
4. If you want to investigate the results further, click **Next**, and you can review the results for each snapshot. This helps you to identify the situations that cause problems.

You can validate the configuration as many times as you like and on any LPR camera and with different settings.

Auto-configure

Auto-configuration of the LPR camera overwrites any manual changes you have made to the settings. You can select this option if, for example, you have made manual changes that have not given you good recognition results.

1. From the **Recognition settings** tab, click **Auto-configure**.
A new dialog box appears.
2. Confirm that you want to return to auto-configured settings by clicking **Next**.
The system optimizes the settings.
3. Click **Close**.
4. If prompted, confirm to save the configuration.
5. Review and validate (see [Validate configuration on page 40](#)) the new settings.

Working with license plate match lists

License plate match lists (explained)

License plate lists are collections of license plates that you want your LPR solution to treat in a special way. License plate recognitions are compared with these lists and if there is a match, the system triggers an LPR event. The events are stored on the event server and can be searched for and viewed on the **LPR** tab in XProtect Smart Client.

By default, events are stored for 24 hours. To change this, open the **Options** dialog box in the Management Client and on the **Event Server Settings** tab, in the **Keep events for** field, enter a new time frame.

After specifying a license plate match list, you can set up additional events and alarms to be triggered on a match.

Examples:

- A company headquarter uses a list of executive management's company car license plates to grant executives access to a separate parking area. When executives' license plates are recognized, the LPR solution triggers an output signal that opens the gate to the parking area
- A chain of gas stations creates a list of license plates from vehicles that have previously left gas stations without paying for their gas. When such license plates are recognized, LPR triggers output signals that activate an alarm and temporarily block the gas supply to certain gas pumps

Triggered events can also be used for making cameras record in high quality or similar. You can even use an event to trigger combinations of such actions.

Unlisted license plates list (explained)

Often you would trigger an event when a license plate that is included in a list is recognized, but you can also trigger an event with a license plate which is **not** included in a list.

Example: A private car park uses a list of license plates to grant residents' vehicles access to the car park. If a vehicle with a license plate that is not in the list approaches the car park, the LPR solution triggers an output signal which lights a sign telling the driver to obtain a temporary guest pass from the security office.

To trigger a surveillance system event, when a license plate that is **not** on a list is recognized, use the **Unlisted license plates** list. You select it for a camera like any other list (see [Match lists tab on page 35](#)) and set it up like any other list (see [Events triggered by LPR on page 45](#)).

Add new license plate match lists

1. In the **Site Navigation pane**, select **License plate match lists**, right-click and select **Add New**.
2. In the window that appears, give the list a name and click **OK**.

As soon as you have created a license plate list, it becomes visible in the **License plate match list** and on the **Match lists** tab for all your LPR cameras.

3. If you want to add columns to the match list, click **Custom field** and specify the columns in the dialog box that opens (see [Edit custom fields properties on page 44](#)).
4. To update the match list, use the **Add**, **Edit**, **Delete** buttons (see [Edit license plate match lists on page 42](#)).
5. Instead of defining the match list directly in the Management Client, you can import a file (see [Import/export license plate match lists on page 43](#)).
6. If prompted, confirm to save changes.

Edit license plate match lists

1. In the **Site Navigation pane**, select **License plate match lists**.
2. Go to the Overview pane. Click the relevant list.
3. The **License plate match list information** window opens.
4. To include new rows to your list, click **Add** and fill out the fields:

- Do not include any spaces
- Always use capital letters

Examples: *ABC123* (correct), *ABC 123* (incorrect), *abc123* (incorrect)

- You can use wildcards in your license plate match lists. Do this by defining plates with a number of '?'s and the letter(s) and/or number(s) which must appear at specific places

Examples: *?????A*, *A?????*, *???1??*, *22??33*, *A?B?C?* or similar

5. If prompted, confirm to save changes.

Import/export license plate match lists

You can import a file with a list of license plates that you want to use in a license plate match list. You have the following import options:

- Add license plates to the existing list
- Replace the existing list

This is useful if, for example, the lists are managed from a central location. Then all local installations can be updated by distributing a file.

Similarly, you can export the complete list of license plates from a match list to an external location.

Supported file formats are .txt or .csv.

To import:

1. In the **Site Navigation pane**, click **License plate match lists** and select the relevant list.
2. To import a file, click **Import**.
3. In the dialog box, specify the location of the import file and the import type. Click **Next**.
4. Await the confirmation and click **Close**.

To export:

1. To export a file, click **Export**.
2. In the dialog box, specify the location of the export file and click **Next**.
3. Click **Close**.
4. You can open and edit the exported file in, for example, Microsoft Excel.

License plate match list properties

Name	Description
Name	Shows the name of the list. If needed, you can change the name.
Custom fields	Click to specify which license plate entry columns that you or the client user can add additional information to. See Edit custom fields properties on page 44 .
Search	Search the list for specific license plates, numbers, patterns or similar. If needed, you can use ? as a single wildcard

Name	Description
<p>Add</p>	<p>Click to add a license plate.</p> <ul style="list-style-type: none"> Do not include any spaces Always use capital letters <p>Examples: <i>ABC123</i> (correct), <i>ABC 123</i> (incorrect), <i>abc123</i> (incorrect)</p> <ul style="list-style-type: none"> You can use wildcards in your license plate lists. Do this by defining plates with a number of ?'s and the letter(s) and/or number(s) which must appear at specific places <p>Examples: <i>?????A</i>, <i>A?????</i>, <i>???1??</i>, <i>22??33</i>, <i>A?B?C?</i> and similar.</p> <p>Some regional areas might have exceptions to these rules. For example, personalized plates with spaces. Plates with two sets of characters which must be recognized separately by an underscore character (_). Or plates from certain regions with letters on a different background color on parts of the license plate.</p> <p>Example: </p>
<p>Edit</p>	<p>Click to edit a license plate. You can select multiple rows for editing.</p>
<p>Delete</p>	<p>Click to delete the selected license plate(s).</p>
<p>Import</p>	<p>Click to import license plates from any comma-separated file, for example a .txt-file or .csv-file (see Import/export license plate match lists on page 43).</p>
<p>Export</p>	<p>Click to export the entire license plate list to a comma-separated file, for example a .txt-file or .csv-file (see Import/export license plate match lists on page 43).</p>
<p>Rows per page</p>	<p>Select how many license plates to display in one page (one screen). You can choose between 50 to 1000 rows.</p>
<p>Events triggered by list match</p>	<p>Select which event(s) should be triggered by a list match (see Events triggered by LPR on page 45). You can choose between all available types of events defined in your system.</p>

Edit custom fields properties

You can add columns to your license plate match lists for additional information. You define the name and number of columns as well as the field content.

The XProtect Smart Client users can update the information in the columns but not the columns themselves.

Name	Description
Add	Adds a column to the match list. Enter a name for the column.
Edit	Click to edit the name of the column.
Delete	Deletes a column.
Up	Changes the order of the columns.
Down	Changes the order of the columns.

Events triggered by LPR

After you have created license plate match lists (see [Add new license plate match lists on page 42](#)), you can associate them with all types of events defined in your system.

The type of events available depends on the configuration of your system. In connection with LPR, events are used to trigger output signals for, for example, raising of parking barrier or making cameras record in high quality. You can also use an event to trigger combinations of such actions. See [License plate match lists \(explained\) on page 41](#) for more examples.

Set up system events triggered by list matches

1. Expand **Servers**, click **License plate match list** and select the list to which you want to associate an event.
2. In the **License plate match list** information window, next to the **Events triggered by list match** selection field, click **Select**.
3. In the **Select triggered events** dialog box, select one or more events.
4. If prompted, confirm to save changes.
5. The event is now associated with recognitions on the selected license plate match list.

To trigger a surveillance system event, when a license plate that is **not** on a list is recognized, configure the **Unlisted license plates** list.

Alarms triggered by LPR

You can associate some types of alarms with events from XProtect LPR. Do the following:

1. Create the license plate match list (see [Add new license plate match lists on page 42](#)) you want to match license plates against.
2. Add and configure your LPR camera(s) (see [Add LPR camera on page 30](#)).
3. In the **Site Navigation pane**, expand **Alarms**, right-click **Alarm Definitions** and select to create a new alarm.
4. The **Alarm Definition Information** window appears. Select the relevant properties (see [Alarm definitions for LPR on page 46](#)).
5. If prompted when done, confirm to save changes.
6. Configure the alarm data settings for LPR (see [Alarm data settings for LPR on page 46](#)).

Alarm definitions for LPR

Except for defining **Triggering events**, the settings for **Alarm Definitions** are the same for LPR as for the remaining part of the system.

To define triggering events related to LPR, select the event message to use when the alarm is triggered:

1. In the **Triggering events** field, in the top drop-down list, decide what type of event to use for the alarm. The list offers **License plate match lists** and **LPR server** events (see [Working with license plate match lists on page 41](#)).
2. In the second drop-down list, select the specific event message to use. If you selected **License plate match lists** in the drop-down above, select a license plate list. If you selected **LPR server**, select the relevant LPR server event message:
 - LPR camera connection lost
 - LPR camera running
 - LPR server not responding
 - LPR server responding

Alarm data settings for LPR

In the Management Client, you must make two specific **Alarm List Configuration** elements available for selection in XProtect Smart Client.

These two elements are used for configuring alarm lists in the **Alarm Manager** tab in XProtect Smart Client. The relevant elements are **Object**, **Tag**, and **Type**, which are essential for recognizing license plate numbers (Object) and country codes (Tag).

Do the following in the Management Client:

1. In the **Site Navigation pane**, expand **Alarms**, select **Alarm Data Settings**.
2. On the **Alarm List Configuration** tab, select **Object**, **Tag**, and **Type** and click **>**.

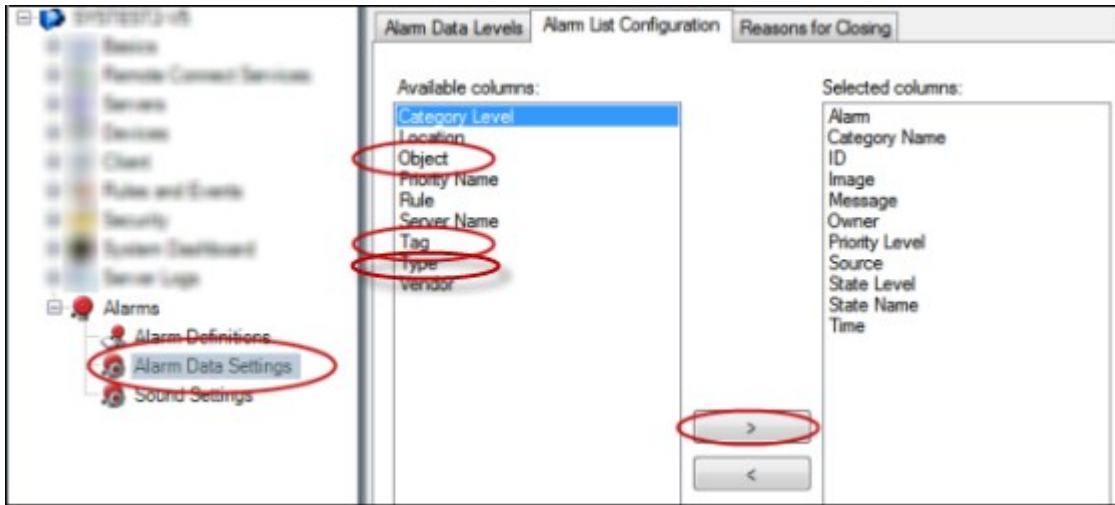

3. If prompted, confirm to save changes.

Maintenance

LPR Server Manager (explained)

After installing an LPR server, you can check the status of its services with the XProtect LPR Server Manager. You can, for example, start and stop the LPR Server service, view status messages, and read log files.

- Access LPR server state information via the LPR Server Manager tray icon in the notification area of the **computer running the LPR server**



In the Management Client, you can get a full overview of the status of your LPR servers (see [View LPR server information on page 26](#)).

Start and stop LPR Server service

The LPR Server service starts automatically after installation. If you have stopped the service manually, you can restart it manually.

1. Right-click the LPR Server Manager icon in the notification area.
2. From the menu that appears, select **Start LPR Server service**.
3. If needed, select **Stop LPR Server service** to stop the service again.

Show LPR server status

1. On your LPR server, right-click the LPR Server Manager icon in the notification area.
2. From the menu that appears, select **Show LPR server status**.

If the system is running without problems, the status is: All LPR cameras running.

Other statuses are:

- Service not responding
- Not connected to surveillance system
- Service not running
- Event Server not connected
- Unknown error
- X of Y LPR cameras running

Show LPR server log

Log files are a useful tool for monitoring and troubleshooting the status of the LPR Server service. All entries are time-stamped, with the most recent entries at the bottom.

1. In the notification area, right-click the LPR Server Manager icon.
2. From the menu that appears, select **Show LPR server Log File**.

A log-viewer lists the server activities with time stamps.

Change LPR server settings

The LPR server must be able to communicate with your management server. To enable this, you specify the IP address or host name of the management server during the installation of the LPR server.

If you need to change the address of the management server, do the following:

1. Stop (see [Start and stop LPR Server service on page 48](#)) the LPR Server service.
2. In the notification area, right-click the LPR Server Manager icon.
3. From the menu that appears, select **Change settings**. The **LPR Server service settings** window appears.
4. Specify the new values and click **OK**.
5. Restart the LPR Server service.

Upgrade

Upgrade XProtect LPR

To upgrade XProtect LPR, you follow the same steps as for installation (see [Install XProtect LPR on page 24](#)).

If you upgrade from XProtect LPR 1.0 to XProtect LPR 2016, some recognition settings are not compatible with those from the previous configuration. To apply the new settings, you must save your configuration. The settings that previously allowed you to flip, rotate and invert the colors of the video have been removed. If you still need these functions, you must change the settings on the cameras themselves.

Uninstall XProtect LPR

If you want to remove XProtect LPR from your system, uninstall the two components separately using the regular Windows removal procedure:

- On the computers where the XProtect LPR plug-in is installed, uninstall *Milestone XProtect LPR [version] Plug-in*
- On the computers where the XProtect LPR server is installed, uninstall *Milestone XProtect LPR [version] Server*



helpfeedback@milestone.dk

About Milestone

Milestone Systems is a leading provider of open platform video management software; technology that helps the world see how to ensure safety, protect assets and increase business efficiency. Milestone Systems enables an open platform community that drives collaboration and innovation in the development and use of network video technology, with reliable and scalable solutions that are proven in more than 150,000 sites worldwide. Founded in 1998, Milestone Systems is a stand-alone company in the Canon Group. For more information, visit <https://www.milestonesys.com/>.

