

User Guide

MOBOTIX 3MP Speed Dome IR Light Camera

© 2022 MOBOTIX AG



Table of Contents

Table of Contents	2
Before You Start	5
Support	6
Safety Notes	6
Legal Notes	7
Overview	9
Features	10
Package Contents	10
Dimensions	11
Accessories	12
Further Reading	14
Connection	15
Camera Cabling	16
Camera Connectors	17
microSD Card Slot	18
Reset Button	18
Connecting Power	18
Connect Ethernet Cable	19
Connect Audio and Alarm I/O	19
Installation	21
General Remarks	22
Camera Installation	22
Installing to a Wall	22
Installing to a Ceiling	22
Configuration	23
System Requirements	24
Accessing the Camera	24
Setting the Video Resolution	26
Exporting/Importing Configuration Files	27
Menu Reference	29
The Camera Menu	32
The “Home” Tab	33
Function Items on Home Page	34
The “System” Tab	37
System	37
Security	38

Network	44
DDNS	51
Mail	51
FTP	52
HTTP	52
Events (Alarm Settings)	52
Autotracking	63
Storage Management	77
Recording	80
Schedule	81
File Location (Snapshots and Web Recording)	82
View Information	82
Factory Default	83
Software Version	84
Software Upgrade	84
Maintenance	84
The “Streaming” Tab	85
Video Configuration	85
Video Rotation	88
Video Text Overlay	88
Video OCX Protocol	89
Audio (Audio Mode and Bit Rate Settings)	90
The “Camera” Tab	91
Exposure	92
White Balance	93
Picture Adjustment	96
IR Function	97
Noise Reduction	98
WDR Function	99
Digital Zoom	99
Backlight	99
Profile	100
TV System	100
The “PTZ” Tab	101
Preset	101
Cruise	102
Auto Pan	103
Sequence	103

Table of Contents

Home Function	104
Tilt Range	105
Privacy Mask	105
PTZ Setting	107
RS485	107
The “Logout” Tab	108
Appendix A: Installing UPnP Components	108
Appendix B: Converting IP Addresses from Decimal to Binary	108
Technical Support Information	111
Technical Specifications	112

Before You Start

This section contains the following information:

Support	6
Safety Notes	6
Legal Notes	7

Support

If you need technical support, please contact your MOBOTIX dealer. If your dealer cannot help you, he will contact the support channel to get an answer for you as quickly as possible.

If you have internet access, you can open the MOBOTIX help desk to find additional information and software updates. Please visit:

www.mobotix.com > [Support](#) > [Help Desk](#)



Safety Notes

- To ensure that the unit is not affected by vibration, twisting, etc., properly tighten all mounting screws.
- This product must not be used in locations exposed to the dangers of explosion.
- Do not look directly into the infra-red LEDs that may be active on the product.
- Do not use this product in a dusty environment.
- Protect this product from moisture or water entering the housing.
- Install this product as outlined in this document. A faulty installation can damage the product!
- Do not replace batteries of the camera. Risk of explosion may occur if the battery is replaced by an incorrect type.
- This equipment is not suitable for use in locations where children are likely to be present.
- External power supplies must comply with the Limited Power Source (LPS) requirements and share the same power specifications with the camera.
- When using a Class I adapter, the power cord shall be connected to a socket-outlet with proper ground connection.
- To comply with the requirements of EN 50130-4 regarding the power supply of alarm systems for 24/7 operation, it is highly recommended to use an uninterruptible power supply (UPS) for backing up the power supply of this product.
- This equipment is to be connected only to PoE networks without routing to other networks.

NOTE! Observe the [MOBOTIX MOVE Installation Hints](#) document to ensure optimum performance of the camera features.

Legal Notes

Legal Aspects of Video and Sound Recording

You must comply with all data protection regulations for video and sound monitoring when using MOBOTIX AG products. Depending on national laws and the installation location of the cameras, the recording of video and sound data may be subject to special documentation or it may be prohibited. All users of MOBOTIX products are therefore required to familiarize themselves with all applicable regulations and to comply with these laws. MOBOTIX AG is not liable for any illegal use of its products.

Declaration of Conformity

The products of MOBOTIX AG are certified according to the applicable regulations of the EC and other countries. You can find the declarations of conformity for the products of MOBOTIX AG on www.mobotix.com under **Support > Download Center > Marketing & Documentation > Certificates & Declarations of Conformity**.

RoHS Declaration

The products of MOBOTIX AG are in full compliance with European Unions Restrictions of the Use of Certain Hazardous Substances in Electrical and Electronic Equipment (RoHS Directive 2011/65/EC) as far as they are subject to these regulations (for the RoHS Declaration of MOBOTIX, please see www.mobotix.com, **Support > Download Center > Marketing & Documentation > Brochures & Guides > Certificates**).

Disposal

Electrical and electronic products contain many valuable materials. For this reason, we recommend that you dispose of MOBOTIX products at the end of their service life in accordance with all legal requirements and regulations (or deposit these products at a municipal collection center). MOBOTIX products must not be disposed of in household waste! If the product contains a battery, please dispose of the battery separately (the corresponding product manuals contain specific directions if the product contains a battery).

Disclaimer

MOBOTIX AG does not assume any responsibility for damages, which are the result of improper use or failure to comply to the manuals or the applicable rules and regulations. Our General Terms and Conditions apply. You can download the current version of the **General Terms and Conditions** from our website at www.mobotix.com by clicking on the corresponding link at the bottom of every page.

Overview

This section contains the following information:

Features	10
Package Contents	10
Dimensions	11
Accessories	12
Further Reading	14

Features

The MOBOTIX MOVE 3MP Speed Dome IR Light Camera is much more than just standard: The extremely fast panning and tilt technology with powerful, long-lasting and at the same time energy-saving electric motors obtains the desired results more quickly. Clear images, even at the highest zoom level and under any lighting conditions, are also a part of our Premium PTZ camera's seamless, complete range of features.

- Servo Feedback – No Drifting
- WDR up to 120 dB
- Electronic Image Stabilizer (EIS)
- H.264/H.265/MJPEG Simultaneous Streaming
- IR LEDs (working distance up to 200 m)
- Triple power (UPoE/DC12 V/AC24 V)
- IP66/IK10 (housing only)
- ONVIF Profile S/G/T Support
- Temp. Range –55 to 55 °C/-67 to 131 °F with heater
- 3D Motion Compensated Noise Reduction (MCTF)
- Smart Event Functions
- Text Overlay and Privacy Masks
- Smart Low Bitrate Control
- Triple Stream Support
- RS485 Support
- Up to 40x Optical Zoom
- Auto-tracking

NOTE! Observe the [MOBOTIX MOVE Installation Hints](#) document to ensure optimum performance of the camera features.

Package Contents

Check the package for the items listed below.



3MP Speed Dome IR Light Camera



M4 security screw with sealing

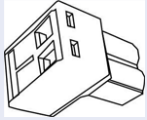

2-pin power terminal block (for DC12V)



3-pin power terminal block (for AC24V)

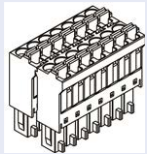

14-pin alarm and audio I/O terminal block

NOTE! To purchase a power adapter, contact MOBOTIX for further information.

CAUTION! Do not replace batteries of the camera. Risk of explosion may occur if the battery is replaced by an incorrect type.

Dimensions

NOTE! Download the drilling template from the MOBOTIX website: www.mobotix.com > [Support](#) > [Download Center](#) > [Marketing & Documentation](#) > [Drilling Templates](#).

CAUTION! Always print or copy the drilling template at 100% of the original size!

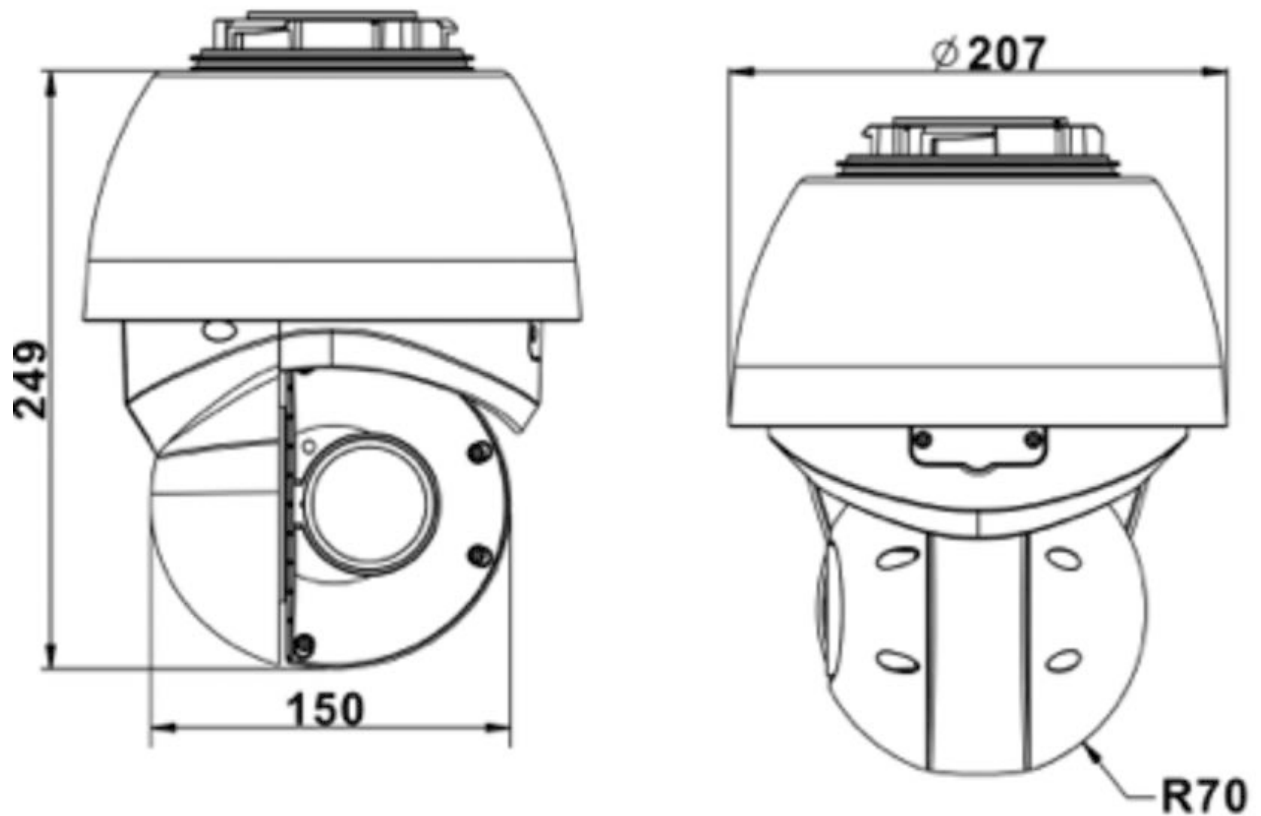





Fig. 1: 3MP Speed Dome IR Light Camera: All measurements in mm

Accessories

Picture	Order Code	Description
	Mx-M-SD-C	Corner Mount for MOBOTIX MOVE SpeedDome models (only in combination with SpeedDome Wall Mount Mx-M-SD-W/WM)
	Mx-M-SD-GN	Parapet Mount (Gooseneck) with integrated junction box for MOBOTIX MOVE SpeedDome models
	Mx-M-SD-P	Pole Mount for MOBOTIX MOVE SpeedDome models (only in combination with SpeedDome Wall Mount Mx-M-SD-W/WM)

Picture	Order Code	Description
	Mx-M-SD-PM	Pendant Mount Kit 25 cm for MOBOTIX MOVE SpeedDome models
	Mx-M-SD-PMEXT	Pendant mount extension 25 cm for use with Pendant Mount Kit Mx-M-SD-PM
	Mx-M-SD-W	Wall Mount for MOBOTIX MOVE SpeedDome models; can be combined with Pole Mount Mx-M-SD-P or Corner Mount Mx-M-SD-C
	Mx-M-SD-WM	Wall Mount with room for optional junction box Mx-M-SD-WMJB for MOBOTIX MOVE SpeedDome models
	Mx-M-SD-WMJB	Wall Mount Junction Box for MOBOTIX MOVE SpeedDome models
	Mx-NPA-UPOE1A-60W	UPoE Network Power Injector 60 W
	Mx-A-ETP1A-2601-SET	Media Converter Set Ethernet (PoE+) – Twisted-Pair

Further Reading

Manuals and Quick Installation documents



Technical Specifications



MOBOTIX MOVE Installation Hints



Connection

This section contains the following information:

Camera Cabling	16
Camera Connectors	17
microSD Card Slot	18
Reset Button	18
Connecting Power	18
Connect Ethernet Cable	19
Connect Audio and Alarm I/O	19

Camera Cabling

The camera is rated IP66 to prevent water from entering the camera. However, water might still enter the camera if it is being improperly installed. Please make sure the warnings below are strictly followed when installing the camera.

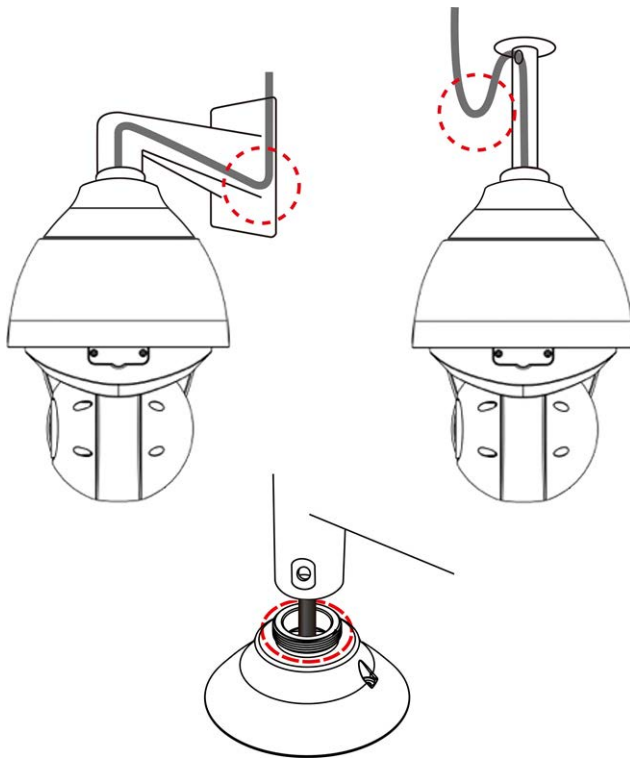

- Place all cables and the adapter in dry and well-waterproofed environments, e.g. waterproof boxes. This will prevent moisture from accumulating inside the camera and from penetrating cables.
- While running cables, slightly bend the cables to a U-shaped curve (see top images in figure above) to make a low point. This will prevent water from entering the camera along the cables from above.
- The cable entry hole of the outdoor mounting kit (see bottom image in figure above) needs to be sealed with thread seal tape to avoid water from entering the camera.

NOTE!

This camera must be installed by qualified personnel and the installation should conform to all local codes.

Camera Connectors

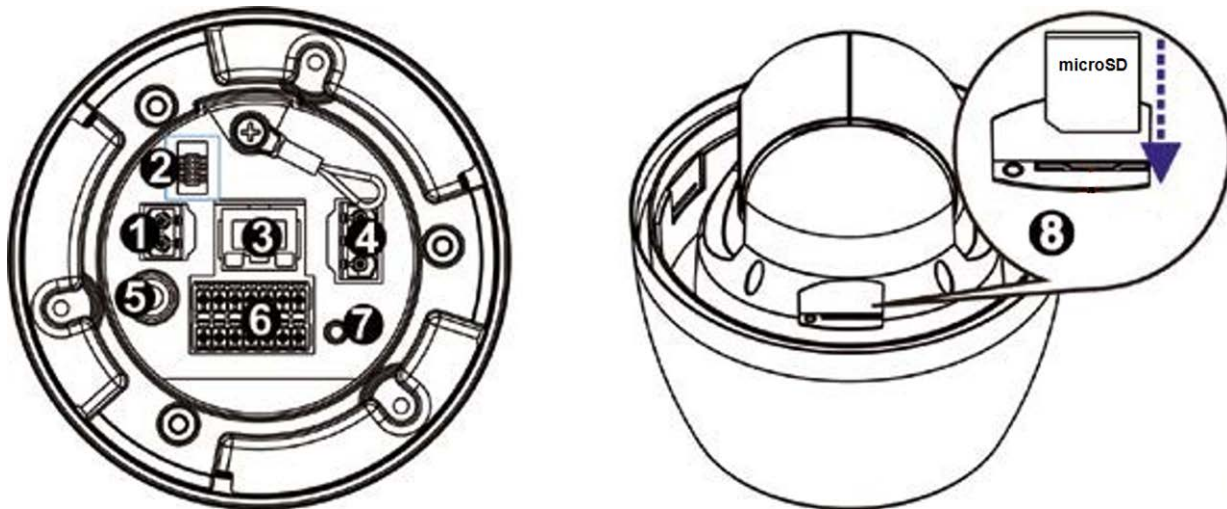

No.	Connector	Definition
1	Power Connector (DC12V)	DC12V power connection
2	Console Connector	This connector is used to burn firmware into the camera when the camera is returned for repair/maintenance. Please contact the camera manufacturer for further information.
3	RJ-45 Port	For network and PoE+ connections
4	Power Connector (AC24V)	AC24V power connection (see Camera Cabling, p. 16 below)
5	BNC*	For analog video output (available only with max. 2 activated streams)
6	Audio/Alarm I/O & RS485 Connector**	Audio/Alarm I/O & RS485 connection (see Audio/Alarm I/O & RS485 Connector, p. 19 below)
7	Reset Button	Press the button with a proper tool for at least 20 seconds to restore the system.
8	SD Card Slot	Insert the SD card into the card slot to store videos and snapshots. Do not remove the SD card when the camera is powered on.

*Contact the manufacturer for a compatible BNC cable.

**Do NOT connect an external power supply to the alarm I/O connector of the camera.

NOTE! To purchase a power adapter, please contact MOBOTIX for further information.

microSD Card Slot

- Insert the microSD card into the card slot to store videos and snapshots.
- Do not remove the microSD card when the camera is powered on.

NOTE!

It is not recommended to record with the microSD card for 24/7 continuously, as it may not be able to support long term continuous data read/write. Please contact the manufacturer of the microSD card for information regarding the reliability and life expectancy.

Reset Button

Press the Reset button with a proper tool for at least 20 seconds to apply the factory defaults.

Connecting Power

Using Power over Ethernet (PoE)

Use a forced 4-pair UPoE switch and connect the Ethernet cable to the RJ-45 port of the camera.

Using AC24V

To power up the camera, connect the AC24V power adapter to the power connector of the camera and the power outlet.

Diagram and Pin Definition for AC24V Power Connection

Pin	Definition
1	AC24V L
2	GND
3	AC24V N

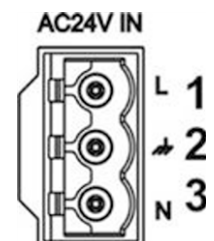

Connect Ethernet Cable

Ethernet Cable Connection

Connect one end of the Ethernet cable to the RJ-45 connector of the camera and plug the other end of the cable into the network switch or PC.

NOTE!

- The length of the Ethernet cable should not exceed 100 m/300 ft.
- Check the status of the link indicator and the activity indicator LEDs of the switch. If the LEDs are unlit, please check the LAN connection.
- In some cases, an Ethernet crossover cable may be needed when connecting the camera directly to the PC.

Ethernet Connector LEDs



- Green **Link** LED indicates good network connection.
- Orange **Activity** LED flashes for network activity indication.

Connect Audio and Alarm I/O

Audio/Alarm I/O & RS485 Connector

Please refer to the diagram and pin definition tables below for using the audio/alarm I/O & RS485 connection.

Pin	Definition
1	Audio Out
2	GND (Audio I/O)
3	Alarm Out A1
4	Alarm Out A2
5	Alarm Out B1
6	Alarm Out B2
7	RS485 D+
8	RS485 D-
9	Alarm In 4

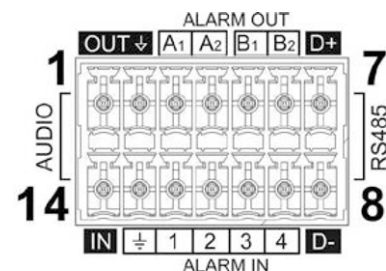

Connection

Connect Audio and Alarm I/O

Pin	Definition
10	Alarm In 3
11	Alarm In 2
12	Alarm In 1
13	GND (Alarm I/O and RS485)
14	Audio In

Installation

This section contains the following information:

General Remarks	22
Camera Installation	22
Installing to a Wall	22
Installing to a Ceiling	22

General Remarks

Read the instructions provided in this chapter thoroughly before installing the camera.

NOTE! This camera must be installed by qualified personnel and the installation must conform to all local codes.

NOTE! Observe the [MOBOTIX MOVE Installation Hints](#) document to ensure optimum performance of the camera features.

Camera Installation

The 3MP Speed Dome IR Light Camera cannot be mounted to walls or ceilings without accessories. Please refer to [Accessories, p. 12](#) to find the type of mount that is suitable for your situation.

To install the camera using one of these accessories, please refer to the corresponding Quick Installation document available on www.mobotix.com > [Support](#) > [Download Center](#) > [Marketing & Documentation](#) > [Manuals](#) in the *Speed Dome Accessories* section.

Installing to a Wall

You can install the camera to a wall using the following accessories:

- Corner Mount **Mx-M-SD-C** (only in combination with SpeedDome Wall Mount Mx-M-SD-W/WM)
- Parapet Mount **Mx-M-SD-GN** (Gooseneck) with integrated junction box
- Pole Mount **Mx-M-SD-P** (only in combination with SpeedDome Wall Mount Mx-M-SD-W/WM)
- Wall Mount **Mx-M-SD-W** can be combined with SD Pole Mount Mx-M-SD-P or Corner Mount Mx-M-SD-C
- Wall Mount **Mx-M-SD-WM** with room for optional junction box Mx-M-SD-WMJB

Installing to a Ceiling

You can install the camera to a wall using the following accessories:

- Pendant Mount Kit 25 cm **Mx-M-SD-PM**
- Optional 25 cm extension **Mx-M-SD-PMEXT**

Configuration

This section contains the following information:

System Requirements	24
Accessing the Camera	24
Setting the Video Resolution	26
Exporting/Importing Configuration Files	27

System Requirements

To perform the IP camera via web browser, please ensure the PC is in good network connection and meets system requirements as described below.

Items	System requirements
Personal Computer	Minimum: <ul style="list-style-type: none">▪ Intel® Core™ i5-2430M @ 2.4 GHz▪ 4 GB RAM Recommended : <ul style="list-style-type: none">▪ 8 GB RAM
Operating System	Windows 7 or later operating system
Web Browser	Any current web browser
Network Card	10Base-T (10 Mbps), 100Base-TX (100 Mbps) or 1000Base-T operation

NOTE! The ITE is to be connected only to PoE networks without routing to the outside plant or equivalent description.

Accessing the Camera

Accessing the Camera

The 3MP Speed Dome IR Light Camera supports all current browsers without requiring any additional plug-ins or add-ons (e.g. for H.264/H.265/MJPEG support).

Camera Login

The default IP address of the camera is: 10.x.x.x. By default, the camera starts as DHCP client and automatically tries to get an IP address from a DHCP server.

1. Enter the camera's IP address in the URL bar of the web browser and hit "Enter".
2. Enter the default username (**admin**) and password (**meinsm**).

NOTE! User names and passwords are case sensitive.

3. You will be prompted to set a new admin user password.

NOTE! The password can have between 6 and 16 characters (at least one digit, no special characters allowed).

4. After setting a new password, you will be prompted to log in again. Remember to use the new password.



Zoom and Focus Adjustment

The live image will be displayed on the Home page when the camera is successfully accessed. If zoom or focus is not at the desired position, please use the function buttons on the Home page to adjust zoom and focus.

NOTE! Refer to section [Menu Reference, p. 29](#) of the Speed Dome WDR IP camera for more button function details.

Setting the Video Resolution

To edit the video configuration settings, select **Streaming > Video Configuration**.

Default Resolution

The following table lists the default resolution of the camera.

IP Camera Model	WDR on/off	Default Resolution
3MP Speed Dome IR Light Camera Mx-SD1A-340-IR		H.265/H.264: 2065 × 1533 (30 fps) + MJPEG: 1080 × 720 (30 fps)

NOTE! The maximum resolution of the camera can only be achieved when using **H.264/H.265** as encoding. When using **MJPEG** encoding, the *maximum resolution is limited to 1920 × 1080 pixels*.

Exporting/Importing Configuration Files

To export and import configuration files, you can access the Maintenance page on the user-friendly browser-based configuration interface.

To edit the Maintenance settings, select **System > Maintenance**.

You can export configuration files to a specified location and retrieve data by uploading an existing configuration file to the camera. This is especially convenient to make multiple cameras having the same configuration.

Export

You can save the system settings by exporting the configuration file (.bin) to a specified location for future use.

- Click on the **Export** button, and the popup File Download window will come out.
- Click on **Save** and specify a desired location for saving the configuration file.

Upload

To upload a configuration file to the camera, click on **Browse** to select the configuration file, and then click on the **Upload** button for uploading.

Menu Reference

This section contains the following information:

The Camera Menu	32
The “Home” Tab	33
Function Items on Home Page	34
The “System” Tab	37
System	37
Security	38
Network	44
DDNS	51
Mail	51
FTP	52
HTTP	52
Events (Alarm Settings)	52
Autotracking	63
Storage Management	77
Recording	80
Schedule	81

File Location (Snapshots and Web Recording)	82
View Information	82
Factory Default	83
Software Version	84
Software Upgrade	84
Maintenance	84
The “Streaming” Tab	85
Video Configuration	85
Video Rotation	88
Video Text Overlay	88
Video OCX Protocol	89
Audio (Audio Mode and Bit Rate Settings)	90
The “Camera” Tab	91
Exposure	92
White Balance	93
Picture Adjustment	96
IR Function	97
Noise Reduction	98
WDR Function	99
Digital Zoom	99
Backlight	99
Profile	100
TV System	100
The “PTZ” Tab	101
Preset	101
Cruise	102
Auto Pan	103
Sequence	103
Home Function	104
Tilt Range	105
Privacy Mask	105
PTZ Setting	107
RS485	107
The “Logout” Tab	108
Appendix A: Installing UPnP Components	108

Appendix B: Converting IP Addresses from Decimal to Binary 108

The Camera Menu

The camera's Home Page shows these main tabs at the top:

The “Home” Tab, p. 33

You can monitor the live video of the targeted area.

The “System” Tab, p. 37

The administrator can set host name, system time, root password, network related settings, etc. Further details will be interpreted in chapter System.

The “Streaming” Tab, p. 85

The administrator can configure video format, video compression, video OCX protocol, video frame rate and audio compression in this page.

The “Camera” Tab, p. 91

This tab is only available for the administrator and user accounts with camera control privileges. The tab includes these sections: **Exposure, White Balance, Sharpness, 2D/3DNR, Digital Zoom, WDR,** etc.

The “PTZ” Tab, p. 101

This tab is only available for the administrator and user accounts with camera control privileges. The tab includes these sections: **Preset, Cruise, Auto Pan, Sequence, Home Function, Tilt Range, Privacy Mask, PTZ Setting,** and **RS485.**

The “Logout” Tab, p. 108

Click on the tab to log out of the camera system. Click on **Login** to log in again with a different username and password, for example.

The “Home” Tab

Click on the tab **Home** to access the Home Page. There are several function buttons on this page. Detailed information of each item is as described in the following section.

The screenshot shows the MOBOTIX MOVE Home page interface. At the top, there are navigation tabs: Home, System, Streaming, Camera, PTZ, and Logout. A Language dropdown menu is set to English, and a Video Time display shows 2022/08/03 09:14. Below the navigation is a Stream 1 dropdown menu labeled Video Stream Selection. The main content area displays a live video feed of a train station. Below the video feed are several control panels:

- Zoom Adjustment:** Includes buttons for ZOOM, WIDE, TELE, a zoom level indicator (11x zoom x11), and a ZOOM button.
- Focus Adjustment:** Includes buttons for FOCUS, NEAR, FAR, AUTO, MANUAL, and ZOOM.
- Iris Adjustment:** Includes buttons for IRIS, CLOSE, OPEN, and RESET.
- Stream Information:** A dropdown menu showing Stream1 MJPEG bitrate: low compression, high quality and Stream2 H264 bitrate: 4096 kbps.
- Control Panel:** A row of icons for Open Control Panel, Video Quality Information, Full Screen, Snapshot, Pause Video, Record Video, and Manual Trigger.

NOTE! The function buttons on the Home page will vary according to different camera models.

Function Items on Home Page

Multiple Languages Support

Multiple languages are supported, including German, English, Spanish, French, Italian, Japanese, Portuguese, Russian, Simplified Chinese and Traditional Chinese for the viewer window interface.

Display Stream Selection

According to the streaming setting, you can choose the one stream to display from the drop-down menu.

Control Panel (On/Off)

Click on  to open the control panel and on  to close it.



- **Pan/Tilt Direction Control**

Click on the arrows to pan and tilt the camera into the corresponding direction.

- **Run Preset/Cruise/Sequence**



- Select a set of preset points you have defined in [Preset Setting, p. 102](#).
- Select a cruise path you have defined in [Cruise Setting, p. 102](#).
- Select a sequence line you have defined in [Preset Setting, p. 102](#).

- **PT Speed**

Select a number between 1 (slow) and 10 (fast) to set the pan/tilt speed of the camera when using the **Pan/Tilt Direction Control** buttons.

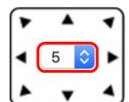

Video Quality

Click to show/hide the video quality information including bitrate and compression.

Full Screen

Use this button to switch the image display to full screen. Alternatively, right click on the **Live Video** pane and select **Fullscreen**.

To exit full screen mode:

- Tap **Esc** on the keyboard.
- Double-click on the **Live Video** pane.
- Right-click on the **Live Video** pane and select **Normal view**.

Snapshot

Click on the button and the JPEG snapshots will automatically be saved in the appointed place. The default place of saving snapshots is: C:\. To change the storage location, please see [File Location \(Snapshots and Web Recording\)](#), p. 82 for further details.

Live View (Pause/Restart)

Click on **Pause** to disable video streaming, the live video will be displayed as black. Click on **Restart** to show the live video again.

Web Recording (On/Off)

Click on **Record** and the Live View through the web browser will be directly recorded to the specific location on the local hard drive, which could be configured in the File Location page. The default storage location for the web recording is: C:\. Please see [File Location \(Snapshots and Web Recording\)](#), p. 82 for further details.

Manual Trigger (On/Off)

Click on **Manual Trigger** to activate/deactivate the manual trigger. Please see [Manual Trigger](#), p. 69 for further details.

Zoom Adjustment

Wide/Tele

Hold the **WIDE/TELE** button, and implement continuous zoom adjustment.

For zoom lens models, optical zoom in/out functions can also be implemented by moving the cursor to the live video pane and scrolling the mouse wheel in Normal View display mode.

Focus Adjustment

- **Auto Focus (Continuous AF)**

Click on the **Auto** button to enable AF mode. In this mode, the camera will keep in focus automatically and continuously regardless of zoom changes or any view changes. The focus status will also be displayed above the live video pane.

- **Manual**

Click on **Manual**, and you can adjust the focus manually via the **Near/Far** buttons.

Menu Reference

The “Home” Tab

- **Near/Far**

Hold the **Near/Far** button, and implement continuous focus adjustment. The focus status will also be displayed above the live video pane.

Iris Adjustment

- **Close:** Closes the iris (image gets darker).
- **Open:** Opens the iris (image gets brighter).
- **Reset:** Resets the iris to the default setting.

Pan/Tilt Direction Control

In the live video pane, left click and drag the pointer  in any direction to move the camera.

Set Center Mode

In **center mode**, you can click on any point in the live image and the camera will move this point to the center of the image.

- Right-click on the live video pane and select **Set Center Mode**.
- Click on the point of interest and the camera moves this point to the center of the live image.

To end center mode, right-click on the live video pane and select **Set Emulated Joystick Mode** to return to the regular pan/tilt direction control (see [Pan/Tilt Direction Control](#), p. 36 above).

Optical/Digital Zoom Control

- **Normal View** display mode:
Zoom in/out by moving the cursor to the live video pane and rotate the mouse wheel.
- **Full Screen** display mode:
Rotate the mouse wheel anywhere to zoom in/out.

Digital zoom is only available if it has been activated in **PTZ > Camera-Misc 1** (see [The “PTZ” Tab](#), p. 101). Once the camera reaches the limit of its optical zoom, it will automatically switch to digital zoom.

The “System” Tab

The **System** tab contains the following sections:

System, Security, Network, DDNS, Mail, FTP, HTTP, Events, Autotracking, Storage Management, Recording, Schedule, File Location, View Information, Factory Default, Software Version, Software Upgrade, Maintenance.

The screenshot shows the MOBOTIXMOVE web interface. At the top, there is a navigation bar with 'Home', 'System' (selected), 'Streaming', 'Camera', 'PTZ', and 'Logout'. A language dropdown is set to 'English'. On the left, a vertical menu lists various system settings. The 'System' section is active, displaying the following configuration options:

- Host Name :** [Text input field]
- Time zone :** [Dropdown menu: GMT+00:00 Gambia, Liberia, Morocco, England]
- Enable daylight saving time**
 - Time offset:** [Text input: 01:00:00]
 - Start date:** [Month: Jan] [Day: 1st] [Day of week: Sun] **Start time:** [Text input: 00:00:00]
 - End date:** [Month: Jan] [Day: 1st] [Day of week: Sun] **End time:** [Text input: 00:00:00]
 - Time format:** [Dropdown menu: yyyy/mm/dd]
- Sync with computer time**
 - PC date:** [Text input: 2022/08/03] [format: yyyy/mm/dd]
 - PC time:** [Text input: 09:15:27] [format: hh:mm:ss]
- Manual**
 - Date:** [Text input: 2016/04/01] [format: yyyy/mm/dd]
 - Time:** [Text input: 00:00:00] [format: hh:mm:ss]
- Sync with NTP server**
 - NTP server:** [Text input: 0.0.0.0] [placeholder: [host name or IP address]]
 - Update interval:** [Dropdown menu: Every hour]

A **Save** button is located at the bottom right of the configuration area.

NOTE! Only administrators can access the **System** configuration page.

System

To edit the system settings, select **System > System**.

Host Name

The name is for camera identification. If the alarm function (see [Events \(Alarm Settings\), p. 52](#)) is enabled and is set to send alarm messages by Mail/FTP, the host name entered here will be displayed in the alarm message.

Time Zone

Select the time zone from the drop-down menu according to the location of the camera.

Enable Daylight Saving Time

To enable DST, please check the item and then specify the time offset and the DST duration. The format for time offset is [hh:mm:ss]; for instance, if the amount of time offset is one hour, please enter “01:00:00” into the field.

Time format

Choose a time format (yyyy/mm/dd or dd/mm/yyyy) from the drop-down menu. The format of the date and time displayed above the live video window will be changed according to the selected format.

Sync with Computer Time

Select the item, and video date and time display will synchronize with the PC's.

NOTE! Users MUST click on **Save** to confirm the setting. Otherwise, the time will not be synced.

Manual

The administrator can set video date and time manually. Entry format should be identical with the examples shown next to the enter fields.

Sync with NTP Server

Network Time Protocol (NTP) is an alternate way to synchronize the camera's clock with a NTP server. Please specify the server that is wished to synchronize in the entry field. Then select an update interval from the drop-down menu. For further information about NTP, please open the web site www.ntp.org.

NOTE! The synchronization will be done every time the camera boots up.

Click on **Save** to confirm the setting.

Security

To edit the security settings, select **System > Security**.

Click on **Security**, there will be a drop-down menu with tabs including **User**, **HTTPS**, **IP Filter**, and **IEEE 802.1X**.

User

To edit the user settings, select **System > Security > User**.

Admin Password

This item is for the administrator to reset password. Enter the new password in **Admin password** and **Confirm password**. The input characters/numbers will be displayed as dots for security purposes. Click on **Save** to confirm the changes. After the changes are confirmed, the web browser will ask the administrator to re-login to the camera with the new password.

NOTE! The password can have between 6 and 16 characters (at least one digit, no special characters allowed).

Add User

This item is for the administrator to add new users. Enter the new user’s name in **User name** and the password in **User password**. Username can be up to 16 characters, and the password can have between 6 and 16 characters (at least one digit, no special characters). Click on **Add** to add the new user. The name of the new added user will be displayed in the **User name** drop-down menu under **Manage User**. There is a maximum of twenty user accounts.

Activate the boxes below to give privileges for functions:

- **I/O access**

This item supports fundamental functions that enable users to view the live video when accessing to the camera.

- **Camera control**

This item allows the appointed user to change camera parameters on the **Camera** and **Pan Tilt** setting page.

- **Talk/Listen**

This item allows the appointed user in the local site (camera site) to communicate with, for instance, the administrator in the remote site.

Manage User

- **Delete user**

Pull down the **User name** drop-down menu and select the username that is wished to be deleted. Click on **Delete** to remove the selected name.

- **Edit user**

Pull down the **User name** drop-down menu and select the username. Click on **Edit** and a popup window will appear. In the appeared window, enter the new user password and reset the privileges. Click on **Save** to confirm the changes. Then click on **Close** to complete the editing.

HTTP Authentication Setting

This setting allows secured connections between the IP camera and web browser by enforcing access controls to web resources. When users approach to the web browser, it’ll ask for username and password, which protects the camera settings or live streaming information from snooping. There are two security models available: Basic and Digest. Refer to the descriptions below for more details.

- **Basic**

This mode can only provide basic protection for the connection security. There will still be risks for the password being intercepted.

- **Digest**

Digest mode is a safer option for protection. The password is sent in an encrypted format to prevent it from being stolen.

NOTE! Users MUST click on **Save** to apply the setting.

Streaming Authentication Setting

This setting provides security against unauthorized users from getting streaming via Real Time Streaming Protocol (RTSP). If the setting is enabled, users will be requested to enter user name and password before viewing the live streams. There are three security modes available: Disable, Basic and Digest. Refer to the descriptions below for more details.

- **Disable**

If disable mode is selected, there will be no security provided to against unauthorized access. Users will not be asked to input user name and password for authentication.

- **Basic**

This mode can only provide basic protection for the live streams. There will still be risks for the password being intercepted.

- **Digest**

Digest mode is a safer option for protection. The password is sent in an encrypted format to prevent it from being stolen.

NOTE! Users MUST click on **Save** to apply the setting.

Enable Account Lockout Function

The Account Lockout Function is to lock out an account when someone tries to log on unsuccessfully several times in a row. To protect user’s account, “Account Lockout Function” is activated when multiple login failures occur. Check the box **Enable Account Lockout Function** and enter the number of threshold and duration.

- **Threshold**

Threshold is a maximum number of login attempts, ranging from 5-20 times. The default value is 5 (attempts).

- **Duration**

Duration is the length of time that the account remains locked once the account lockout function is triggered, ranging from 1-60 minute(s). The default value is 10 (mins).

HTTPS

To edit the HTTPS settings, select **System > Security > HTTPS**.

HTTPS allows secure connections between the camera and the web browser using **Secure Socket Layer (SSL)** or **Transport Layer Security (TLS)**, which ensure camera settings or

Username/Password info from snooping. It is required to install a self-signed certificate or a CA-signed certificate for implementing HTTPS.

To use HTTPS on the camera, an HTTPS certificate must be installed. The HTTPS certificate can be obtained by either creating and sending a certificate request to a Certificate Authority (CA), or by creating a self-signed HTTPS certificate.

Enable HTTPS

Check the box to enable HTTPS secure connection. Once enabled, choose one of the following secure modes.

- **HTTP & HTTPS**

Under this mode, HTTP & HTTPS secure connections are enabled.

- **HTTPS only**

Under this mode, the secure connection is ensured by HTTPS only.

Click on **Save** to save the setting.

Generate Self-Signed Certificate

Before a CA-issued certificate is obtained, you can create and install a self-signed certificate first.

Beneath **Generate Self-signed Certificate**, click on **Create** and provide the requested information as outlined under [Provide the Certificate Information, p. 41](#).

NOTE! The self-signed certificate does not provide the same high level of security as when using a CA-issued certificate.

Install Signed Certificate

Click on **Create Certificate Request** under **Install Signed Certificate** to create and submit a certificate request in order to obtain a signed certificate from CA.

Provide the request information in the create dialog. Please [Provide the Certificate Information, p. 41](#) for more details.

When the request is complete, the subject of the Created Request will be shown in the field. Click on **Properties** below the Subject field, copy the PEM-formatted request and send it to the selected CA.

When the signed certificate is returned, install it by uploading the signed certificate.

Provide the Certificate Information

To create a Self-signed HTTPS Certificate or a Certificate Request to CA, please enter the information as requested.

Information Item	Create Self Signed Certificate	Create Certificate Request
Country	✓	✓
State or Province	✓	✓

Menu Reference

The “System” Tab

Information Item	Create Self Signed Certificate	Create Certificate Request
Locality	✓	✓
Organization	✓	✓
Organizational Unit	✓	✓
Common Name	✓	✓
Valid Days	✓	-

- **Country**

enter a two-letter combination code to indicate the country the certificate will be used in. For instance, type in “US” to indicate United States.

- **State or Province**

Enter the local administrative region.

- **Locality**

Enter other geographical information.

- **Organization**

Enter the name of the organization to which the entity identified in “Common Name” belongs.

- **Organization Unit**

Enter the name of the organizational unit to which the entity identified in “Common Name” belongs.

- **Common Name**

Indicate the name of the person or other entity that the certificate identifies (often used to identify the website).

- **Valid Days**

Enter the period in days (1 to 9999) to indicate the valid period of certificate.

Click on **OK** to save the Certificate Information after completing the setting.

IP Filter

To edit the IP filter settings, select **System > Security > IP Filter**.

With IP Filter, you can allow or deny specific IP addresses from accessing the camera.

Enable IP Filter

Check the box to enable the IP Filter function. Once enabled, the listed IP addresses (IPv4) in the **Filtered IP Addresses** list box will be allowed/denied to access the camera.

Select **Allow** or **Deny** from the drop-down menu and click on **Apply** to determine the IP filter behavior.

Add IP Address

Input IP address at the blank space below the **Filtered IP Address** list and click **Add**. The newly-added address will be shown in the list. Up to 256 IP address entries can be specified.

In addition, to filter a group of IP addresses, enter an address at the blank space followed with a slash and a number ranging from 1 to 31, e.g. 192.168.2.81/30. The number after the slash can define how many IP addresses will be filtered. For details, please refer to [Example: Filtering a Group of Consecutive IP Addresses](#), p. 43 below.

Delete IP Address

To remove an IP address from the **Filtered IP Address** list, select the address and click on **Delete**.

Example: Filtering a Group of Consecutive IP Addresses

1. Convert 192.168.2.81/30 to binary numbers (see [Appendix B: Converting IP Addresses from Decimal to Binary](#), p. 108). The binary numbers are 11000000.10101000.00000010.01010001. The number “30” after the slash is referring to the first 30 digits of the binary numbers.
2. Convert a few IP addresses before and after 192.168.2.81 to binary numbers. Then compare their first 30 digits with the binary numbers of 192.168.2.81.
 1. Convert 192.168.2.80 to binary numbers. The binary numbers are 11000000.10101000.00000010.01010000. The first 30 digits are the same with the binary numbers of 192.168.2.81, thus 192.168.2.80 will be filtered.
 2. Convert 192.168.2.79 to binary numbers. The binary numbers are 11000000.10101000.00000010.01001111. The first 30 digits are different with the binary numbers of 192.168.2.81, thus 192.168.2.79 will not be filtered. This also means the IP addresses before 192.168.2.79 will not be filtered. Therefore, you can stop converting the IP addresses before 192.168.2.79 to binary numbers.
 3. Repeat the same procedure in “a” with the IP addresses after 192.168.2.81. Stop when the situation occurs in “b” happened. Namely, the 30th digit of the binary numbers of IP address 192.168.2.84 is different, and will not be filtered.

As a result, the IP addresses 192.168.2.80 to 192.168.2.83 will be filtered when entering 192.168.2.81/30. The following table clearly shows the 30th digit of the binary numbers of IP addresses 192.168.79 and 192.168.84 are different from the others. Therefore, these two IP addresses will not be filtered.

IP Addresses	Binary Numbers
192.168.2.79	11000000.10101000.00000010.01001111
192.168.2.80	11000000.10101000.00000010.01010000
192.168.2.81	11000000.10101000.00000010.01010001
192.168.2.82	11000000.10101000.00000010.01010010

Menu Reference

The “System” Tab

IP Addresses	Binary Numbers
192.168.2.83	11000000.10101000.00000010.01010011
192.168.2.84	11000000.10101000.00000010.01010100

IEEE 802.1X

To edit the IEEE 802.1x settings, select **System > Security > IEEE 802.1X**.

The camera is allowed to access a network protected by 802.1X/EAPOL (Extensible Authentication Protocol over LAN).

Choose **On** to enable the IEEE 802.1X function.

Select one among the four protocol types: **EAP-MD5**, **EAP-TLS**, **EAP-TTLS** and **EAP-PEAP**.

Users need to contact with the network administrator for gaining certificates, user IDs and passwords.

CA Certificate

The CA certificate is created by the Certification Authority for the purpose of validating itself. Upload the certificate for checking the server’s identity.

Client Certificate/Private Key

Upload the Client Certificate and Private Key for authenticating the camera itself.

Settings

- **Identity**

Enter the user identity associated with the certificate. Up to 16 characters can be used.

- **Private Key Password**

Enter the password (maximum 16 characters) for user identity.

Save IEEE 802.1X

Click on **Save** to save the IEEE 802.1X/EAP- TLS setting.

Network

To edit the network settings, select **System > Network**.

Click on **Network**, there will be a drop-down menu with tabs including **Basic**, **QoS**, **SNMP**, and **UPnP**.

Basic

To edit the basic settings, select **System > Network > Basic**.

This setting page is for setting a new IP address for the camera, configuring other network-related parameters and activating IPv6 address (if the network supports it).

General

This setting menu is for configuring a new IP address for the camera. To setup an IP address, please find out the network type first. Contact the network provider for it. Then refer to the network type and follow the instructions to setup the IP address.

NOTE! If the network type is Point-to-Point Protocol over Ethernet (PPPoE), please obtain the PPPoE username and password from the network provider.

■ Get IP address automatically (DHCP)

Select the item and click **Save** to confirm the new setting. A note for camera system reboot will appear. Click **OK** and the camera system will restart. The camera will be assigned with a new IP address. Close the web browser and search the camera through the installer program: DeviceSearch.exe. Refer to the steps below to connect the camera through “DeviceSearch” software.

NOTE! Before searching the camera through DeviceSearch.exe, please record the camera’s MAC address, which can be found on the label or on the package container of the camera, for later use and identification in the future.

- Double-click on the program DeviceSearch.exe.
- After its window appears, click on **Device Search** on the top. All the finding IP devices will be listed in the page.
- Find the camera by its MAC address.
- Then double-click or right click and select **Browse** to access the camera directly by the web browser.
- A prompt window requesting for the username and the password will appear. Enter the username and the password to login to the camera.

■ Use fixed IP address

Select the item and insert the new IP address, e.g. 192.168.7.123. Note that the inserted IP address should be in the same LAN as the PC’s IP address. Then go to the Default gateway (explained later) blank and change the setting, e.g. 192.168.7.254. Click on **Save** to confirm the new setting. A note for system restart will appear, click **OK** and the camera system will restart. Wait for 15 seconds. The camera’s IP address in the URL bar will be changed, and users have to login again.

When using a static IP address to connect the camera, you can access the camera by inputting the IP address in the URL bar and hit **Enter** on the keyboard. Alternatively, you can access the camera by the installer program: DeviceSearch.exe. Refer to the steps below to connect the camera through “DeviceSearch” software with a static IP address.

- Double-click on the program DeviceSearch.exe.
- After its window appears, click on **Device Search** on the top. All the finding IP devices will be listed in the page.
- Find the camera by its IP address.
- Then double-click or right click and select **Browse** to access the camera directly by the web browser.
- A prompt window requesting for the username and the password will appear. Enter the username and the password to login to the camera.

- **IP address**

- This is necessary for network identification.

- **Subnet mask**

- It is used to determine if the destination is in the same subnet. The default value is “255.255.255.0”.

- **Default gateway**

- This is the gateway used to forward frames to destinations in different subnet. Invalid gateway setting will fail the transmission to destinations in different subnet.

- **Primary DNS**

- Primary DNS is the primary domain name server that translates hostnames into IP addresses.

- **Secondary DNS**

- Secondary DNS is a secondary domain name server that backs up the primary DNS.

■ Use PPPoE

For the PPPoE users, enter the PPPoE username and password into the enter fields, and click on **Save** to complete the setting.

Advanced

The following introduces the camera’s Web Server port, RTSP port, MJPEG over HTTP port, and HTTPS port.

- **Web Server port**

The default web server port is 80. With the default web server port ‘80’, you can simply input the IP address of the camera in the URL bar of a web browser to connect the camera. When the web server port is changed to any number other than 80, users have to enter the camera’s IP address followed by a colon and the port number. For instance, a camera whose IP address is set as 192.168.0.100 and web server port as 8080 can be connected by entering “http://192.168.0.100:8080” in the URL bar.

- **RTSP port**

The default setting of RTSP Port is 554; the RTSP Port should be set as 554 or from the range 1024 to 65535.

- **MJPEG over HTTP port**

The default setting of MJPEG over HTTP Port is 8008; the MJPEG over HTTP Port should be set as 8008 or from the range 1024 to 65535.

- **HTTPS port**

The default setting of HTTPS Port is 443; the HTTPS Port should be set as 443 or from the range 1024 to 65535.

NOTE! Please make sure the port numbers set above are not the same with each other; otherwise, network conflict may occur.

- **RTSP URL**

When users use RTSP players to view the live streaming, the camera provides the flexibility to configure the streaming access name for stream 1 to stream 4. The streaming format is **rtsp://ip address:rtsp port/access name**. Take a camera whose IP address is set as 192.168.0.100 for example, if users enter “liveview.1” in the blank of stream 1 access name, the streaming address of stream 1 will be **rtsp://192.168.0.100:554/liveview.1**.

NOTE! The maximum length of the access name is 32 characters, and the valid characters are A-Z, a-z, 0-9 and !#\$%&’-.@^_~.

IPv6 Address Configuration

If the network supports IPv6, you can check the box beside **Enable IPv6** and click **Save**. An IPv6 address will appear beside **Address**, and you can use it to connect to the camera.

QoS

To edit the QoS (*Quality of Service*) settings, select **System > Network > QoS**.

QoS allows providing differentiated service levels for different types of traffic packets, which guarantees delivery of priority services especially when network congestion occurs. Adapting the Differentiated Services (DiffServ) model, traffic flows are classified and marked with DSCP (DiffServ Codepoint) values, and thus receive the corresponding forwarding treatment from DiffServ capable routers.

DSCP Settings

The DSCP value range is from 0 to 63. The default DSCP value is 0 (DSCP disabled). The camera uses the following QoS Classes:

- **Management DSCP**

NOTE! The class consists of HTTP traffic: Web browsing.

- **Stream 1~4 DSCP**

NOTE! You can set the Audio/Video DSCP of each stream.

- **Video DSCP**

The class consists of applications such as MJPEG over HTTP, RTP/RTSP and RTSP/HTTP.

- **Audio DSCP**

This setting is only available for the cameras that support audio.

NOTE! To enable this function, please make sure the switches/routers in the network support QoS.

VLAN

To edit the VLAN settings, select **System > Network > VLAN**.

Check the box **Enable VLAN** to activate the VLAN function. Enter the VLAN ID. The allowed range of VLAN ID is from 1 to 4095. The default value is 20.

CoS

CoS stands for *Class of Service*. The higher the value of CoS is, the better transmission performance will be. The value also determines the transmission priority among the following three classes:

- **Live Video**

The value range is from 0 to 7.

- **Live Audio**

The value range is from 0 to 7.

- **Management**

The value range is from 0 to 7.

SNMP

To edit the SNMP (Simple Network Management Protocol) settings, select **System > Network > SNMP**.

With Simple Network Management Protocol (SNMP) support, the camera can be monitored and managed remotely by the network management system.

SNMP v1/v2

- **Enable SNMP v1/v2**

Select the version of SNMP to use by checking the box.

- **Read Community**

Specify the community name that has read-only access to all supported SNMP objects. The default value is “public”.

- **Write Community**

Specify the community name that has read/write access to all supported SNMP objects (except read-only objects). The default value is “private”.

SNMP v3

SNMP v3 supports an enhanced security system that provides protection against unauthorized users and ensures the privacy of the messages. Users will be requested to enter security name, authentication password and encryption password while setting the camera connections in the network management system. With SNMP v3, the messages sent between the cameras and the network management system will be encrypted to ensure privacy.

- **Enable SNMP v3**

Enable SNMP v3 by checking the box.

- **Security Name**

The maximum length of the security name is 32 characters.

NOTE! The valid characters are A-Z, a-z, 0-9 and !#\$%&'-.@^_~.

- **Authentication Type**

There are two authentication types available: MD5 and SHA. Select **SHA** for a higher security level.

- **Authentication Password**

The authentication password must be 8 characters or more. The input characters/numbers will be displayed as dots for security purposes.

NOTE! The valid characters are A-Z, a-z, 0-9 and !#\$%&'-.@^_~.

- **Encryption Type**

There are two encryption types available: DES and AES. Select **AES** for a higher security level.

- **Encryption Password**

The minimum length of the encryption password is 8 characters and the maximum length is 512 characters. The input characters/numbers will be displayed as dots for security purposes. The encryption password can also be left blank. However, the messages will not be encrypted to protect privacy.

NOTE! The valid characters are A-Z, a-z, 0-9 and !#\$%&'-.@^_~.

Traps for SNMP v1/v2/v3

Traps are used by the camera to send messages to a management system for important events or status changes.

- **Enable Traps**

Check the box to activate trap reporting.

- **Trap address**

Enter the IP address of the management server.

- **Trap community**

Enter the community to use when sending a trap message to the management system.

Trap Option

- **Warm Start**

A Warm Start SNMP trap signifies that the SNMP device, i.e. IP camera, performs software reload.

Click on **Save** when completed.

UPnP

To edit the UPnP settings, select **System > Network > UPnP**.

UPnP Setting

- **Enable UPnP**

When the UPnP is enabled, whenever the camera is presented to the LAN, the icon of the connected cameras will appear in My Network Places to allow for direct access.

NOTE! To enable this function, please make sure the UPnP component is installed on the computer. Please see [Appendix A: Installing UPnP Components, p. 108](#) for the installation procedure.

- **Enable UPnP port forwarding**

When the UPnP port forwarding is enabled, the camera is allowed to open the web server port on the router automatically.

NOTE! To enable this function, please make sure that the router supports UPnP and it is activated.

- **Friendly name**

Set a name for the camera for identity.

Click on **Save** when finished.

DDNS

To edit the DDNS settings, select **System > DDNS**.

Dynamic Domain Name System (DDNS) allows a host name to be constantly synchronized with a dynamic IP address. In other words, it allows those using a dynamic IP address to be associated to a static domain name so others can connect to it by name.

Enable DDNS

Check the item to enable DDNS.

Provider

Select one DDNS host from the provider list.

Host name

Enter the registered domain name in the field.

Username/E-Mail

Enter the username or E-mail required by the DDNS provider for authentication.

Password/Key

Enter the password or key required by the DDNS provider for authentication.

Mail

To edit the mail settings, select **System > Mail**.

The administrator can send an E-mail via Simple Mail Transfer Protocol (SMTP) when an alarm is triggered. SMTP is a protocol for sending E-mail messages between servers. SMTP is a relatively simple, text-based protocol, where one or more recipients of a message are specified and the message text is transferred.

Two sets of SMTP can be configured. Each set includes SMTP Server, Account Name, Password and E-mail Address settings. For SMTP server, contact the network service provider for more specific information.

Click on **Save** when finished. Then, please click on **Test** to check the connection between the camera and the specified SMTP server.

FTP

To edit the FTP settings, select **System > FTP**.

The administrator can set the camera to send the alarm messages to a specific File Transfer Protocol (FTP) site when an alarm is triggered. You can assign alarm message to up to two FTP sites. Enter the FTP details, which include server, server port, username, password and remote folder, in the fields.

Click on **Save** when finished. Then, please click on **Test** to check the connection between the camera and the specified FTP server.

HTTP

To edit the HTTP settings, select **System > HTTP**.

An HTTP Notification server can listen for the notification messages from the cameras by triggered events. Enter the HTTP details, which include server name (for instance, <http://192.168.0.100/admin.php>), username, and password in the fields. **Alarm** triggered and **Motion Detection** notifications can be sent to the specified HTTP server.

Click on **Save** when finished.

NOTE! Please see **Events > Application > Send HTTP Notification**, p. 55 for the HTTP notification settings.

Events (Alarm Settings)

To edit the events settings, select **System > Events**. You will see these sections:

- **Application**
- **Motion Detection**
- **Network Failure Detection**
- **Periodical Event**
- **Manual Trigger**
- **Audio Detection**

Application

To edit the application settings, select **System > Events > Application**.

The camera supports one alarm input and one relay output for cooperation with alarm system to catch event images. Refer to alarm pin definition below to connect alarm devices to the camera if needed.

Alarm Switch

The default setting for the Alarm Switch function is **Off**. Enable the function by selecting **On**. You can also activate the function according to the schedule previously set in the **Schedule** setting page. Select **By schedule** and click **Please select...** to choose the desired schedule from the drop-down menu.

Alarm Type

Select an alarm type, **Normal close** or **Normal open**, that corresponds with the alarm application.

Triggered Action

The administrator can specify alarm actions that will take when the alarm is triggered. All options are listed as follows.

- **Enable Alarm Output (high/low)**

Select the item to enable alarm relay output.

- **IR Cut Filter**

Select the item and the IR cut filter (ICR) of the camera will be removed (on) or blocked (off) when alarm input is triggered. This function is only available for models with IR cut filter.

NOTE! The IR Function (see [IR Function, p. 97](#)) could not be set as **Auto** mode if this triggered action is enabled.

- **Send Message by FTP/E-Mail**

The administrator can select whether to send an alarm message by FTP and/or E-mail when an alarm is triggered.

■ Upload Image by FTP

Select this item and the administrator can assign an FTP site and configure various parameters. When the alarm is triggered, event images will be uploaded to the appointed FTP site. Note that to implement this function, one of the streaming MUST be set as MJPEG; otherwise, this function will be grayed out and cannot be accessed.

The **Pre-trigger buffer** function allows users to check what caused the trigger. The **Pre-trigger buffer** frame rate could be pre-determined. **Post-trigger buffer** is for users to upload certain amount of images after the alarm input is triggered.

NOTE! The **Pre-trigger buffer** generally ranges from 1 to 20 frames. However, the range will change accordingly if the frame rate of MJPEG on **Streaming > Video Configuration** is 6 or lower.

Check the box **Continue image upload** to upload the triggered images during certain time or keep uploading until the trigger is off. Select **Upload for ___ sec** and enter the duration in the blank. The images of the duration will be uploaded to FTP when the alarm input is triggered. The setting range is from 1 to 99999 sec. Select **Upload while the trigger is active** to make the images keep being uploaded to FTP during the trigger active until the alarm is released. Set the Image frequency as the upload frame rate. The setting range is from 1 to 15 frames.

NOTE! Make sure FTP configuration has been completed. Refer to section FTP for further details.

■ **Upload Image by E-Mail**

Select this item and the administrator can assign an E-mail address and configure various parameters. When the alarm input is triggered, event images will be sent to the appointed E-mail address. Note that to implement this function, one of the streaming MUST be set as MJPEG; otherwise, this function will be grayed out and cannot be accessed.

The **Pre-trigger buffer** function allows users to check what caused the trigger. The **Pre-trigger buffer** frame rate could be pre-determined. On the other hand, **Post-trigger buffer** is for users to upload certain amount of images after alarm input is triggered.

NOTE! The **Pre-trigger buffer** generally ranges from 1 to 20 frames. However, the range will change accordingly if the frame rate of MJPEG on **Streaming > Video Configuration** is 6 or lower.

Check the box **Continue image upload** to upload the triggered images during certain time or keep uploading until the trigger is off. Select **Upload for ___ sec** and enter the duration in the blank. The images of the duration will be uploading by E-mail when the alarm input is triggered. The setting range is from 1 to 99999 sec. Select **Upload while the trigger is active** to make the images keep being uploaded to E-mail during the trigger active until the alarm is released. Set the Image frequency as the upload frame rate. The setting range is from 1 to 15 frames.

NOTE! Make sure SMTP configuration has been completed. Refer to section Mail for further details.

■ **Send HTTP Notification**

Check this item and select the destination HTTP address. Then specify the parameters for event notifications by **Alarm** triggered. When an alarm is triggered, the HTTP notification will be sent to the specified HTTP server.

For instance, if the custom parameter is set as “action=1&group=2”, and the HTTP server name is “http://192.168.0.100/admin.php”, the notification will be sent to HTTP server as “http://192.168.0.100/ admin.php/action=1&group=2” when alarm is triggered.

■ Record Video Clip

Check this item and select a video recording storage type, **SD Card** or **NAS** (Network-Attached Storage). The alarm-triggered recording will be saved into the microSD/SD card or the NAS.

The **Pre-trigger buffer** recording function allows users to check what caused the trigger. The pre-trigger buffer time range is from 1 to 3 sec.

Select **Upload for ___ sec** to set the recording duration after alarm is triggered. The setting range is from 1 to 99999 sec. Select **Upload while the trigger is active** to record the triggered video until the trigger is off.

NOTE! Please make sure the local recording (with microSD/SD card) or the remote recording (with NAS) is activated so that this function can be implemented. Refer to section Recording for further details.

File Name

Enter a file name in the blank, e.g. image.jpg. The file name format of the uploaded image can be set in this section. Please select the one that meets the requirements.

■ Add date/time suffix

File name: imageYYMMDD_HHNNSS_XX.jpg

Y: Year, M: Month, D: Day

H: Hour, N: Minute, S: Second

X: Sequence Number

■ Add sequence number suffix (no maximum value)

File name: imageXXXXXXXX.jpg

X: Sequence Number

■ Add sequence number suffix up to # and then start over

File Name: imageXX.jpg

X: Sequence Number

The file name suffix will end at the number being set. For example, if the setting is up to “10”, the file name will start from 00, end at 10, and then start all over again.

■ Overwrite

The original image in the FTP site will be overwritten by the new uploaded file with a static file name.

Save

Click on **Save** to keep the settings.

Motion Detection

To edit the motion detection settings, select **System > Events > Motion Detection**.

Motion Detection function allows the camera to detect suspicious motion and trigger alarms by comparing sampling pixels in the detection area of two consecutive live images. When motion volume in the detection area reaches/exceeds the determined sensitivity threshold value, the alarm will be triggered.

The function supports up to 4 sets of Motion Detection Settings. Settings can be chosen from the Motion Detection drop-down menu.

Motion Detection

By default, Motion Detection function for each Motion Detection Setting is **Off**. Select **On** to enable Motion Detection. You can also activate the function according to the schedule previously set in the **Schedule** setting page. Select **By schedule** and click **Please select...** to choose the desired schedule from the drop-down menu.

Motion Region Paint

The camera divides the detection area into 1200 (40x30) detection grids; you can draw the motion detection region using the paintbrush.

Check the box **Enable brush** and select the brush size, 1x1, 3x3 or 5x5. Then, left click and drag the mouse cursor to draw the preferred detection region. To erase the drawn detection region, left click and drag the mouse cursor on the colored grids.



Motion Detection Setting

Users could adjust various parameters of Motion Detection in this section.

- **Sampling pixel interval [1-10]:**

This item is used to examine the differences between two frames. You can configure the interval of sampling pixel. The default value is 1. For instance, if users set the interval as 3, IP camera system will take one sampling pixel from every 3 pixels of each row and each column in detection area (refer to the figure below). The alarm will be triggered when differences are detected.

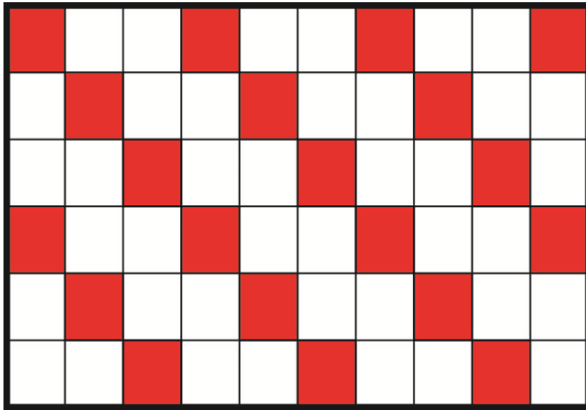

- **Detection level [1-100]:**

You can configure detection level for each sampling pixel. Detection level is how much the camera can accept the differences between two sampling pixels. The smaller the value is, the more minor motions it detects. The default level is 10.

- **Sensitivity level [1-100]:**

The default level is 80, which means if 20% or more sampling pixels are detected differently, system will detect motion. The bigger the value, the more sensitive it is. Meanwhile, when the value is bigger, the red horizontal line in the motion indication window will be lower accordingly.

- **Time interval (sec) [0-7200]:**

The value is the interval between each detected motion. The default interval is 10.

Motion Indication Bar

When Motion Detection function is activated and the motion is detected, the signals will be displayed on the motion indication bar. The motion indication bar will go green or red when there is any motion occurrence in the detection region.

Green suggests the occurring motion is detected and does not exceed the threshold of detection level and sensitivity level. No alarms will be triggered.



Red suggests the ongoing motion exceeds the threshold of detection level and sensitivity level. The alarm will be triggered.

Motion Indication Bar**Triggered Action (Multi-option)**

The administrator can specify alarm actions that will take when motion is detected. All options are listed as follows.

■ Enable Alarm Output (high/low)

Check the item and select the predefined type of alarm output to enable alarm relay output when motion is detected.

■ Send Alarm Message by FTP/E-Mail

The administrator can select whether to send an alarm message by FTP and/or E-mail when motion is detected.

■ Upload Image by FTP

Select this item and the administrator can assign an FTP site and configure various parameters. When motion is detected, event images will be uploaded to the appointed FTP site. Note that to implement this function, one of the streaming MUST be set as MJPEG; otherwise, this function will be grayed out and cannot be accessed.

The **Pre-trigger buffer** function allows users to check what caused the trigger. The **Pre-trigger buffer** frame rate could be pre-determined. On the other hand, **Post-trigger buffer** is for users to upload certain amount of images after motion event occurs.

NOTE! The **Pre-trigger buffer** generally ranges from 1 to 20 frames. However, the range will change accordingly if the frame rate of MJPEG on **Streaming > Video Configuration** is 6 or lower.

Check the box **Continue image upload** to upload the triggered images during certain time or keep uploading until the trigger is off. Select **Upload for __sec** and enter the duration in the blank. The images of the duration will be uploaded to FTP when the motion event occurs.

The setting range is from 1 to 99999 sec. Select **Upload while the trigger is active** to make the images keep being uploaded to FTP during the trigger active until the event stops. Set the Image frequency as the upload frame rate. The setting range is from 1 to 15 frames per second.

NOTE! Make sure FTP configuration has been completed. Refer to section FTP for further details.

■ Upload Image by E-Mail

Select this item and the administrator can assign an E-mail address and configure various parameters. When motion is detected, event images will be sent to the appointed E-mail address. Note that to implement this function, one of the streaming MUST be set as MJPEG; otherwise, this function will be grayed out and cannot be accessed.

The **Pre-trigger buffer** function allows users to check what caused the trigger. The **Pre-trigger buffer** frame rate could be pre-determined. On the other hand, **Post-trigger buffer** is for users to upload certain amount of images after the motion event occurs.

NOTE! The **Pre-trigger buffer** generally ranges from 1 to 20 frames. However, the range will change accordingly if the frame rate of MJPEG on **Streaming > Video Configuration** is 6 or lower.

Check the box **Continue image upload** to upload the triggered images during certain time or keep uploading until the trigger is off. Select **Upload for __sec** and enter the duration in the blank. The images of the duration will be uploading by E-mail when the motion event occurs. The setting range is from 1 to 99999 sec. Select **Upload while the trigger is active** to make the images keep being uploaded to E-mail during the trigger active until the event stops. Set the Image frequency as the upload frame rate. The setting range is from 1 to 15 frames per second.

NOTE! Make sure SMTP configuration has been completed. Refer to section Mail for further details.

■ Send HTTP Notification

Check this item, select the destination HTTP address, and specify the parameters for event notifications by **Motion Detection** triggered. When an alarm is triggered, the notification can be sent to the specified HTTP server.

For instance, if the custom parameter is set as “action=1&group=2”, and the HTTP server name is “http://192.168.0.100/admin.php”, the notification will be sent to HTTP server as “http://192.168.0.100/ admin.php/action=1&group=2” when alarm is triggered.

■ **Record Video Clip**

Check this item and select a video recording storage type, **SD Card** or **NAS** (Network-Attached Storage>. The Motion Detection recording will be stored in microSD/SD card or the NAS when motion is detected.

The **Pre-trigger buffer** recording function allows users to check what caused the trigger. The pre-trigger buffer time range is from 1 sec. to 3 sec. Select **Upload for __ sec** to set the recording duration after motion is triggered. The setting range is from 1 to 99999 sec. Select **Upload while the trigger is active** to record the triggered video until the trigger is off.

NOTE! Please make sure the local recording (with microSD/SD card) or the remote recording (with NAS) is activated so that this function can be implemented. Refer to section Recording for further details.

File Name

Enter a file name in the blank, e.g. image.jpg. The uploaded image’s file name format can be set in this section. Please select the one that meets the requirements.

■ **Add date/time suffix**

File name: imageYYMMDD_HHNNSS_XX.jpg

Y: Year, M: Month, D: Day

H: Hour, N: Minute, S: Second

X: Sequence Number

■ **Add sequence number suffix (no maximum value)**

File name: imageXXXXXXXXX.jpg

X: Sequence Number

■ **Add sequence number suffix up to # and then start over**

File Name: imageXX.jpg

X: Sequence Number

The file name suffix will end at the number being set. For example, if the setting is up to “10”, the file name will start from 00, end at 10, and then start all over again.

■ **Overwrite**

The original image in the FTP site will be overwritten by the new uploaded file with a static file name.

Save

Click on **Save** to keep the settings.

Network Failure Detection

To edit the network failure detection settings, select **System > Events > Network Failure Detection**.

Network Failure Detection allows the camera to ping another IP device (e.g. NVR, VSS, Video Server, etc.) within the network periodically and generates some actions in case of network failure occurs, for instance, a Video Server is somehow disconnected.

Being capable of implementing local recording (through microSD/SD card) or remote recording (via NAS) when network failure happens, the camera can be a backup recording device for the surveillance system.

Detection Switch

The default setting for the Detection Switch function is **Off**. Enable the function by selecting **On**. You can also activate the function according to the schedule time that is previously set in the **Schedule** setting page. Select **By schedule** and click **Please select...** to choose the desired schedule from the drop-down menu.

Detection Type

Input the IP device address and the period of ping time to ping. The camera will ping the IP device every N minute(s). If it fails for up to three times, the alarm will be triggered. The ping time setting range is from 1 to 99 min.

Triggered Action

The administrator can specify alarm actions that will take when network failure is detected. All options are listed as follows.

- **Enable Alarm Output (high/low)**

Select the item to enable alarm relay output.

- **Send Alarm Message by FTP/E-Mail**

The administrator can select whether to send an alarm message by FTP and/or E-mail when an alarm is triggered.

■ Record Video Clip

Check the item and select a video recording storage type, **SD Card** or **NAS** (Network-Attached Storage). The alarm-triggered recording will be saved into the microSD/SD card.

The **Pre-trigger buffer** recording function allows users to check what caused the trigger. The pre-trigger buffer time range is from 1 to 3 sec. Select **Upload for __ sec** to set the recording duration after alarm is triggered. The setting range is from 1 to 99999 sec. Select **Upload while the trigger is active** to record the triggered video until the trigger is off.

NOTE! Please make sure the local recording (with microSD/SD card) or the remote recording (with NAS) is activated so that this function can be implemented. Refer to section Recording for further details.

Save

Click on **Save** to keep the settings.

Autotracking

The **Autotracking** function will automatically detect a moving object in the preset area and follow it according to the defined settings.

NOTE! If this feature is not available, please contact the system installer or your MOBOTIX sales representative for a key to activate **Autotracking**. For more information about activating the Autotracking feature, please see [Entering the Activation Key, p. 63](#).

Click on **System > Autotracking** and the **Autotracking** and **Insert Key** tabs will be shown in the drop-down menu. Enter the setting menu by clicking the **Autotracking** tab.

Entering the Activation Key

To activate the feature, enter the product key in the blank space provided in the **Insert Key** page and click on **OK** to enable the function.

The default setting of the Autotracking function is **Off**. Select **On** to enable the feature.

NOTE! Setting items will be only available after **On** has been selected.

MAX Limit Setting

This setting menu allows users to define a tracking area for the detection and tracking movement of the camera.

To avoid disturbances by the camera’s tracking movement, please click on the **Turn Off** button.

NOTE! The Autotracking function needs to be reactivated to take effect after saving all the necessary settings. Please follow the steps below.

- Select **Off** under **Autotracking** at the top and click on **Save** for confirmation.
- Select **On** under **Autotracking** at the top and click on **Save** for confirmation.

Enable Tilt Limit

Activate the checkbox to enable the tilt limit setting.

Get U Tilt/D Tilt

Please click and drag the PTZ pointer in the view window to the desired up or down tilt position. Then click on the **Get U Tilt/Get D Tilt** button to get the boundary values.

Enable Pan Limit

Activate the checkbox to enable the pan limit setting.

Get L Pan/R Pan

Click and drag the PTZ pointer in the view window to the desired left or right pan position. Then click on the **Get L Pan/Get R Pan** button to get the boundary values.

Detection Range

Detection range can be set to detect motions around the center of the view window. Please choose a value to define the detection area (in percentage) around the center point. The available options are **L(60%)**, **M(50%)** and **S(40%)**.

Preset Setting

In this setting menu, the Autotracking function and its related functions can be activated for the first ten preset points of each sequence line.

NOTE! When **Preset Setting** is activated, the **Home Setting** and the **Guard Timer Setting** will be unavailable.

- **Off/On**
The default setting of the Preset Setting is **Off**. Select **On** to enable the function.
- **Sequence line**
Select a desired sequence line from the drop-down menu to set its Autotracking function.
- **Preset**
Select a desired preset point from the drop-down menu to set its Autotracking function. Please use the **Autotracking** drop-down menu below to activate/deactivate the tracking function for each chosen preset point.

- **Ratio**

Zoom ratio can be set for the camera to automatically zoom in/out when it is tracking a moving object. Please type in the ratio number in the blank space.

- **Guard Time**

Guard time is for defining the maximum tracking time of the camera for each chosen preset point. Please enter the time in seconds (range from 0 to 999) in the blank space. Click the **Set** button on the right to finish setting up a preset point.

NOTE! Repeat the steps from **Sequence line** to **Guard Time** for setting other preset points.

Home Setting

This function allows users to set the main monitoring area as the home position for the camera. In addition, maximum time can also be set for defining the time for the camera to keep watching a stopped tracking object. The camera will return to the home position according to the defined time setting.

NOTE! Preset Setting must be **Off** in order to configure the **Home Setting** function.

- **Off/On**

The default setting of Home Setting is **Off**. Select **On** to enable the function.

- **Home Position**

To set the home position, please click and drag the PTZ pointer in the view window to the desired position. Click on **Set** to confirm the position.

- **Time**

Please type in the time that the camera should keep watching a stopped tracking object. The camera will return to the home position after the defined time period.

- **Go**

Click on **Go** to move the camera to the home position.

Guard Timer Setting

This function allows users to set the main monitoring area as the guard position, and set the duration of time for the camera to track an object.

NOTE! Preset Setting must be **Off** in order to configure the **Guard Timer Setting** function.

- **Off/On**

The default setting of the Guard Timer Setting is **Off**. Select **On** to enable the function.

- **Guard Position**

To set the guard position, please click and drag the PTZ pointer in the view window to the desired position. Click on **Set** to confirm the position.

- **Time**

Please type in the duration of time that the camera should track a moving object.

- **Go**

Click on **Go** to move the camera to the guard position.

Click on **Save** to confirm the settings.

Periodical Event

To edit the periodical event settings, select **System > Events > Periodical Event**.

With Periodical Event setting, you can set the camera to upload images periodically to an FTP site or an E-mail address. For example, if the time interval is set to 60 seconds, the camera will upload images to the FTP site or the E-mail address every 60 seconds. The images to be uploaded are the images before and after the triggered moment. You can define how many images to be uploaded in the **Triggered Action** section of this setting page.

Periodical Event

The default setting for the Periodical Event function is **Off**. Enable the function by selecting **On**.

Time Interval

The default value of the time interval is 60 seconds. The setting range of the time interval is from 60 to 3600 seconds.

Triggered Action

■ Upload Image by FTP

Select this item and the administrator can assign an FTP site and configure various parameters. Images will be uploaded to the appointed FTP site periodically. Note that to implement this function, one of the streaming MUST be set as MJPEG; otherwise, this function will be grayed out and cannot be accessed.

The **Pre-trigger buffer** function can define how many images to be uploaded before the triggered moment. The **Post-trigger buffer** function can define how many images to be uploaded after the triggered moment.

NOTE! The **Pre-trigger buffer** generally ranges from 1 to 20 frames. However, the range will change accordingly if the frame rate of MJPEG on **Streaming > Video Configuration** is 6 or lower.

NOTE! Make sure FTP configuration has been completed. Refer to section FTP of this chapter for further details.

■ Upload Image by E-mail

Select this item and the administrator can assign an E-mail address and configure various parameters. Images will be uploaded to the appointed E-mail address periodically. Note that to implement this function, one of the streaming MUST be set as MJPEG; otherwise, this function will be grayed out and cannot be accessed.

The **Pre-trigger buffer** function can define how many images to be uploaded before the triggered moment. The **Post-trigger buffer** function can define how many images to be uploaded after the triggered moment.

NOTE! The **Pre-trigger buffer** generally ranges from 1 to 20 frames. However, the range will change accordingly if the frame rate of MJPEG on **Streaming > Video Configuration** is 6 or lower.

NOTE! Make sure SMTP configuration has been completed. Refer to section Mail of this chapter for further details.

■ **Upload Image to SD Card**

Select this item, and then the images will be uploaded to the SD card periodically. Note that to implement this function, one of the streaming **MUST** be set as MJPEG; otherwise, this function will be grayed out and cannot be accessed.

The **Pre-trigger buffer** function can define how many images to be uploaded before the triggered moment. The **Post-trigger buffer** function can define how many images to be uploaded after the triggered moment.

NOTE! The **Pre-trigger buffer** generally ranges from 1 to 20 frames. However, the range will change accordingly if the frame rate of MJPEG on **Streaming > Video Configuration** is 6 or lower.

NOTE! Before implementing **Upload Image to SD Card**, please make sure that the SD Card is properly detected and installed. Refer to **Storage Management > SD Card > Device Information** for further details.

File Name

Enter a file name in the blank, e.g. image.jpg. The uploaded image’s file name format can be set in this section. Please select the one that meets the requirements.

■ **Add date/time suffix**

File name: imageYYMMDD_HHNNSS_XX.jpg

Y: Year, M: Month, D: Day

H: Hour, N: Minute, S: Second

X: Sequence Number

■ **Add sequence number suffix (no maximum value)**

File name: imageXXXXXXX.jpg

X: Sequence Number

■ **Add sequence number suffix up to # and then start over**

File Name: imageXX.jpg

X: Sequence Number

NOTE! The file name suffix will end at the number being set. For example, if the setting is up to “10”, the file name will start from 00, end at 10, and then start all over again.

■ **Overwrite**

The original image in the FTP site will be overwritten by the new uploaded file with a static file name.

Save

Click on **Save** to keep the settings.

Manual Trigger

To edit the manual trigger settings, select **System > Events > Manual Trigger**.

With Manual Trigger setting, the current image(s) or video can be uploaded to the appointed destination, such as an FTP site or an E-mail address. The administrator can specify the triggered actions that will take when the users switch the Manual Trigger button to ON. All options are listed as follows.

Manual Trigger

The default setting for the Manual Trigger function is **Off**. Enable the function by selecting **On**. After the Manual Trigger function is enabled, click the Manual Trigger button on the Home page to start uploading data. Click again to stop uploading.

Triggered Action

The administrator can specify alarm actions that will take at an alarm occurrence. All options are listed as follows.

- **Enable Alarm Output (high/low)**

Select these items to enable alarm relay outputs.

- **IR Cut Filter**

Select the item and the IR cut filter (ICR) of the camera will be removed (on) or blocked (off) when alarm input is triggered. This function is only available for models with IR cut filter.

NOTE! The IR Function (see [IR Function, p. 97](#)) could not be set as **Auto** mode if this triggered action is enabled.

- **Send Message by FTP/E-Mail**

The administrator can select whether to send an alarm message by FTP and/or E-mail when an alarm is triggered.

■ Upload Image by FTP

Select this item and the administrator can assign an FTP site and configure various parameters. When the alarm is triggered, event images will be uploaded to the appointed FTP site. Note that to implement this function, one of the streaming MUST be set as MJPEG; otherwise, this function will be grayed out and cannot be accessed.

The **Pre-trigger buffer** function allows users to check what happened to cause the trigger. The **Pre-trigger buffer** frame rate could be pre-determined. On the other hand, **Post-trigger buffer** is for users to upload certain amount of images after the alarm input is triggered.

NOTE! The **Pre-trigger buffer** generally ranges from 1 to 20 frames. However, the range will change accordingly if the frame rate of MJPEG on **Streaming > Video Configuration** is 6 or lower.

Check the box **Continue image upload** to upload the triggered images during certain time or keep uploading until the trigger is off. Select **Upload for __sec** and enter the duration in the blank. The images of the duration will be uploaded to FTP when the alarm input is triggered. The setting range is from 1 to 99999 sec. Select **Upload while the trigger is active** to make the images keep being uploaded to FTP during the trigger active until the alarm is released. Set the Image frequency as the upload frame rate. The setting range is from 1 to 15 frames per second.

NOTE! Make sure the FTP configuration has been completed. Refer to section FTP for further details.

■ **Upload Image by E-Mail**

Select this item and the administrator can assign an E-mail address and configure various parameters. When the alarm is triggered, event images will be sent to the appointed E-mail address. Note that to implement this function, one of the streaming MUST be set as MJPEG; otherwise, this function will be grayed out and cannot be accessed.

The **Pre-trigger buffer** function allows users to check what happened to cause the trigger. The **Pre-trigger buffer** frame rate could be pre-determined. On the other hand, **Post-trigger buffer** is for users to upload certain amount of images after alarm input is triggered.

NOTE! The **Pre-trigger buffer** generally ranges from 1 to 20 frames. However, the range will change accordingly if the frame rate of MJPEG on **Streaming > Video Configuration** is 6 or lower.

Check the box **Continue image upload** to upload the triggered images during certain time or keep uploading until the trigger is off. Select **Upload for __sec** and enter the duration in the blank. The images of the duration will be uploading by E-mail when the alarm input is triggered. The setting range is from 1 to 99999 sec. Select **Upload while the trigger is active** to make the images keep being uploaded to E-mail during the trigger active until the alarm is released. Set the Image frequency as the upload frame rate. The setting range is from 1 to 15 frames per second.

NOTE! Make sure SMTP configuration has been completed. Please see [Mail, p. 51](#) for further details.

■ **Send HTTP notification**

Check this item, select the destination HTTP address, and specify the parameters for event notifications by **Alarm** triggered. When an alarm is triggered, the notification can be sent to the specified HTTP server.

For instance, if the custom parameter is set as “action=1&group=2”, and the HTTP server name is “http://192.168.0.1/admin.php”, the notification will be sent to the HTTP server as “http://192.168.0.1/admin.php?action=1&group=2” when alarm is triggered.

■ Record Video Clip

Check the item and select a video recording storage type, **SD Card** or **NAS** (Network-Attached Storage). The alarm-triggered recording will be saved into the microSD/SD card or the NAS.

The **Pre-trigger buffer** recording function allows users to check what caused the trigger. The pre-trigger buffer time range is from 1 to 3 sec. Select **Upload for __ sec** to set the recording duration after alarm is triggered. The setting range is from 1 to 99999 sec. Select **Upload while the trigger is active** to record the triggered video until the trigger is off.

NOTE! Please make sure the local recording (with microSD/SD card) or the remote recording (with NAS) is activated so that this function can be implemented. Refer to section Recording for further details.

File Name

Enter a file name in the File name field, ex. image.jpg. The uploaded image’s file name format can be set in this section. Please select the one that meets the requirements.

■ Add date/time suffix

File name: imageYYMMDD_HHNNSS_XX.jpg

Y: Year, M: Month, D: Day

H: Hour, N: Minute, S: Second

X: Sequence Number

■ Add sequence number suffix (no maximum value)

File name: imageXXXXXXXXX.jpg

X: Sequence Number

■ Add sequence number suffix up to # and then start over

File Name: imageXX.jpg

X: Sequence Number

NOTE! The file name suffix will end at the number being set. For example, if the setting is up to “10”, the file name will start from 00, end at 10, and then start all over again.

■ Overwrite

The original image in the FTP site will be overwritten by the new uploaded file with a static file name.

Save

Click on **Save** to keep the settings.

Audio Detection

To edit the audio detection settings, select **System > Events > Audio Detection**.

Audio Detection function allows the camera to detect audio and trigger alarms when audio volume in the detected area reaches/exceeds the determined sensitivity threshold value.

NOTE! Audio Detection function is only available for models equipped with Audio I/O function.

Audio Detection

In Audio Detection Setting, the default setting for the Audio Detection function is **Off**. Enable the function by selecting **On**.

Audio Detection Setting

Users could adjust various parameters of Audio Detection in this section.

- **Detection level [1-100]:**

The item is to set detection level for each sampling volume; the smaller the value, the more sensitive it is. The default level is 10.

- **Time interval (sec) [0-7200]:**

The value is the interval between each detected audio. The default interval is 10.

Triggered Action

The administrator can specify alarm actions that will take when audio is detected. All options are listed as follows.

- **Enable Alarm Output (high/low)**

Select these items to enable alarm relay outputs.

- **Send Alarm Message by FTP/E-Mail**

The administrator can select whether to send an alarm message by FTP and/or E-mail when audio is detected.

■ Upload Image by FTP

Select this item and the administrator can assign an FTP site and configure various parameters. When audio is detected, event images will be uploaded to the appointed FTP site. Note that to implement this function, one of the streaming MUST be set as MJPEG; otherwise, this function will be grayed out and cannot be accessed.

The **Pre-trigger buffer** function allows users to check what happened to cause the trigger. The **Pre-trigger buffer** frame rate could be pre-determined. On the other hand, **Post-trigger buffer** is for users to upload certain amount of images after audio event occurs.

NOTE! The **Pre-trigger buffer** generally ranges from 1 to 20 frames. However, the range will change accordingly if the frame rate of MJPEG on **Streaming > Video Configuration** is 6 or lower.

Check the box **Continue image upload** to upload the triggered images during certain time or keep uploading until the trigger is off. Select **Upload for __sec** and enter the duration in the blank. The images of the duration will be uploaded to FTP when the audio event occurs. The setting range is from 1 to 99999 sec. Select **Upload while the trigger is active** to make the images keep being uploaded to FTP during the trigger active until the event stops. Set the Image frequency as the upload frame rate. The setting range is from 1 to 15 frames per second.

NOTE! Make sure FTP configuration has been completed. Refer to section FTP for further details.

■ Upload Image by E-Mail

Select this item and the administrator can assign an E-mail address and configure various parameters. When audio is detected, event images will be sent to the appointed E-mail address. Note that to implement this function, one of the streaming MUST be set as MJPEG; otherwise, this function will be grayed out and cannot be accessed.

The **Pre-trigger buffer** function allows users to check what happened to cause the trigger. The **Pre-trigger buffer** frame rate could be pre-determined. On the other hand, **Post-trigger buffer** is for users to upload certain amount of images after the audio event occurs.

NOTE! The **Pre-trigger buffer** generally ranges from 1 to 20 frames. However, the range will change accordingly if the frame rate of MJPEG on **Streaming > Video Configuration** is 6 or lower.

Check the box **Continue image upload** to upload the triggered images during certain time or keep uploading until the trigger is off. Select **Upload for __sec** and enter the duration in the blank. The images of the duration will be uploading by E-mail when the audio event occurs. The setting range is from 1 to 99999 sec. Select **Upload while the trigger is active** to make the images keep being uploaded to E-mail during the trigger active until the event stops. Set the Image frequency as the upload frame rate. The setting range is from 1 to 15 frames per second.

NOTE! Make sure SMTP configuration has been completed. Refer to section Mail for further details.

■ Send HTTP Notification

Check this item, select the destination HTTP address, and specify the parameters for event notifications by **Audio Detection** triggered. When an alarm is triggered, the notification can be sent to the specified HTTP server.

For instance, if the custom parameter is set as “action=1&group=2”, and the HTTP server name is “http://192.168.0.1/admin.php”, the notification will be sent to HTTP server as “http://192.168.0.1/admin.php? action=1&group=2” when alarm is triggered.

■ Record Video Clip

Check this item and select a video recording storage type, **SD Card** or **NAS** (Network-Attached Storage). The Audio Detection recording will be stored in microSD/SD card or the NAS when audio is detected.

The **Pre-trigger buffer** recording function allows users to check what happened to cause the trigger. The pre-trigger buffer time range is from 1 to 3 sec. Select **Upload for __ sec** to set the recording duration after audio is triggered. The setting range is from 1 to 99999 sec. Select **Upload while the trigger is active** to record the triggered video until the trigger is off.

NOTE! Please make sure the local recording (with microSD/SD card) or the remote recording (with NAS) is activated so that this function can be implemented. Refer to section Recording for further details.

File Name

Enter a file name in the blank, e.g. image.jpg. The uploaded image’s file name format can be set in this section. Please select the one that meets the requirements.

■ Add date/time suffix

File name: imageYYMMDD_HHNNSS_XX.jpg

Y: Year, M: Month, D: Day

H: Hour, N: Minute, S: Second

X: Sequence Number

■ Add sequence number suffix (no maximum value)

File name: imageXXXXXXXX.jpg

X: Sequence Number

■ Add sequence number suffix up to # and then start over

File Name: imageXX.jpg

X: Sequence Number

NOTE! The file name suffix will end at the number being set. For example, if the setting is up to “10”, the file name will start from 00, end at 10, and then start all over again.

■ Overwrite

The original image in the FTP site will be overwritten by the new uploaded file with a static file name.

Save

Click on **Save** to keep the settings.

Storage Management

To edit the storage management settings, select **System > Storage Management**.

Click on **Storage Management**, there will be a drop-down menu with tabs including **SD Card** and **Network Share**.

SD Card

To edit the SD card settings, select **System > Storage Management > SD Card**.

You can implement local recording to the microSD/SDHC/SDXC card up to 1 TB. This page shows the capacity information of the microSD/SD card and a recording list with all the recording files saved on the memory card. You can also format the microSD/SD card and implement automatic recording cleanup through the setting page.

To implement microSD/SD card recording, please go to the **Recording** page (see [Recording, p. 80](#)) for activation.

NOTE! Please format the microSD/SDHC/SDXC card when using it for the first time. Formatting will also be required when a memory card is being used on one camera and later transferred to another camera with different software platform.

It is not recommended to record with the microSD/SD card for 24/7 continuously, as it may not be able to support long term continuous data read/write. Please contact the manufacturer of the microSD/SD card for information regarding the reliability and the life expectancy.

Device Information

After the microSD/SD card is inserted into the camera, the card information such as memory capacity and status will be shown at **Device Information**.

Recording Source

Select a video stream to set as the recording source. The default format of the video stream is **Stream 1**. Select a preferred stream from the drop-down list and click on **Save** to apply the setting.

Recording Filename Format

Select a format as the recording file name format. The default recording file name format is **Start time only**. Select a preferred format from the drop-down list and click on **Save** to apply the setting.

Device Setting

Click on **Format** to format the memory card. Two filesystems are provided, **vfat (default)** and **ext4 (recommended)**. It is recommended to select **ext4** as the filesystem for steady and better performances.

Disk Cleanup Setting

Check **Enable automatic disk cleanup** and specify the time **1~999 day(s) or 1~142 week(s)** and storage limits **1~99% full** to configure disk cleanup settings. Click on **Save** to confirm the settings.

Recording List

Enter the period in the date fields and click on **Search**. Select **Video / JPEG**, and then each video/image file on the microSD/SD card will be listed in the recording list. The maximum file size is 60 MB/per file.

When the recording mode is set as **Always** (consecutive recording) and the microSD/SD card recording is also allowed to be enabled by events triggered, once events occur, the system will immediately implement events recording to the memory card. After the recording of the events are finished, the camera will return to the regular recording mode.

- **Remove**

To remove a file, select the file first, and then click **Remove** button.

- **Sort**

Click on **Sort**, and the files in the Recording list will be listed in name and date order.

The capital letter at the beginning of a name indicates the type of recording:

Initial	Recording Type	Initial	Recording Type
A	Alarm	S	Periodical Event
M	Motion	R	Regular Recording
N	Network Failure	V	Manual Trigger
T	Tampering	U	Audio Detection

- **Download**

To open/download a video clip/image, select the file first, then click on **Download** below the **Recording** list. The selected file window will pop up. Click on the AVI/JPEG file to download the file to the specified location.

Network Share (NAS)

To edit the network share settings, select **System > Storage Management > Network Share**.

You can store the recording videos to a network share folder, or NAS (Network-Attached Storage). A NAS device is used for data storage and data sharing via network. This page displays the capacity information of the network device and a recording list with all the recording files saved on the network device. You can also format the NAS and implement automatic recording cleanup through the setting page.

Device Information

When a NAS is successfully installed, the device information such as the memory capacity and status will be shown at **Device Information**.

Storage Setting

The administrator can set the camera to send the alarm messages to a specific NAS site when an alarm is triggered. Enter the network device details, which include host (the IP of the NAS), share (the folder name of the NAS), user name, and password, in the fields.

Click on **Save** when finished.

Storage Tools

Click on **Format** to format the NAS.

Recording Source

Select a video stream to set as the recording source. The default format of the video stream is **Stream 1**. Select a preferred stream from the drop-down list and click on **Save** to apply the setting.

Recording Filename Format

Select a format to set as the recording file name format. The default recording file name format is **Start time only**. Select a preferred format from the drop-down list and click on **Save** to apply the setting.

Disk Cleanup Setting

Check **Enable automatic disk cleanup** and specify the time **1~999 day(s) or 1~142 week(s)** and storage limits **1~99% full** to configure disk cleanup settings. Click on **Save** to confirm the settings.

Recording List

Each video file on the Network Share will be listed in the Recording list. The maximum file size is 60 MB/per file.

When the recording mode is set as **Always** (consecutive recording) and the NAS recording is also allowed to be enabled by events triggered, once events occur, the system will immediately implement events recording to NAS. After the recording of the events are finished, the camera will return to the regular recording mode.

- **Remove**

To remove a file, select the file first, and then click on **Remove**.

■ **Sort**

Click on **Sort**, and the files in the Recording list will be listed in name and date order. The capital letter at the beginning of a name indicates the type of recording:

Initial	Recording Type	Initial	Recording Type
A	Alarm	S	Periodical Event
M	Motion	R	Regular Recording
N	Network Failure	V	Manual Trigger
T	Tampering	U	Audio Detection

■ **Download**

To open/download a video clip, select the file first, and then click on **download** below the Recording list field. The selected file window will pop up. Click on the AVI file to directly play the video in the player or download it to a specified location.

Recording

To edit the recording settings, select **System > Recording**.

In the **Recording** setting page, you can specify the recording schedule that fits the present surveillance requirement.

Recording

Recording Storage

SD Card
 Network Share

Recording Schedule

Disable
 Always
 Only during time frame

Weekday	Start time	Duration
1 O - - - - - O	00:00	24:00
2 - - - - -	----	----
3 - - - - -	----	----
4 - - - - -	----	----
5 - - - - -	----	----
6 - - - - -	----	----
7 - - - - -	----	----
8 - - - - -	----	----
9 - - - - -	----	----
10 - - - - -	----	----

Sun Mon Tue Wed Thu Fri Sat

Start time: Duration:

Recording Storage

Select a recording storage type, **SD Card** or **Network Share**.

Enable Recording Schedule

Two types of schedule mode are offered: **Always** and **Only during time frame**. You can select **Always** to activate microSD/SD card or Network Share Recording all the time. Or, select a set of schedule from the time frame blank, check specific weekdays and setup the start time (hour:minute) and time period (hour:minute) to activate the recording at certain time frames. The setting range for the duration time is from 00:00 to 168:59. Please click on **Save** to save the setup. To delete a schedule, select one from the schedule list, and click **Delete**.

Schedule

To edit the schedule settings, select **System > Schedule**.

	Weekday	Start time	Duration
1	<input type="radio"/> - - - - - <input type="radio"/>	day	----
2	<input type="radio"/> <input checked="" type="radio"/> <input checked="" type="radio"/> - - - - -	06:00	12:00
3	- - - - -	----	----
4	- - - - -	----	----
5	- - - - -	----	----
6	- - - - -	----	----
7	- - - - -	----	----
8	- - - - -	----	----
9	- - - - -	----	----
10	- - - - -	----	----

Sun Mon Tue Wed Thu Fri Sat

Day
 Night
 Time

Start time: Duration:

Schedules Setup

1. Select a time frame from the time frame list.
2. Check the weekday boxes below to choose the specific weekdays.
3. Select a time mode, Day, Night or Time. Under Time mode, specify the start time (hour:minute) and the time duration (hour:minute) to activate the schedule triggered features. The setting range for the time duration is from 00:00 to 168:59.
4. Click on **Save** to save the setup. Alternatively, click on **Delete** to delete a chosen time frame.

Time Mode

- **Day**

The camera profile will be loaded when IR cut filter is on.

- **Night**

The camera profile will be loaded when IR cut filter is off.

- **Time**

This indicates the start time and the time duration for the schedule.

NOTE! Users MUST select **By schedule** under each feature setting page to enable the schedule function.

File Location (Snapshots and Web Recording)

To edit the file location settings, select **System > File Location**.

You can specify a storage location on the PC or in the hard drive for the snapshots and the live video recordings. The default setting is: C:\. Once the setting is confirmed, click on **Save**, and all the snapshots and the web recordings will be saved in the designate location.

NOTE! Make sure the selected file path contains valid characters such as letters and numbers.

View Information

To edit the view information settings, select **System > View Information**.

Click on **View Information**, there will be a drop-down menu with tabs including **Log File**, **User Information**, and **Parameters**.

Log File

To edit the log file settings, select **System > View Information > Log File**.

Click on the tab to view the system log file. The camera keeps a record of the system’s behavior and information related to the camera. These log data can be exported for future use. Click **generate syslog** and the Save File As dialog window will pop up. The default file name is named after the model name and the MAC address as “Model Name-MAC-log.tgz”. Select the file destination and click **Save** to export the log data.

NOTE! “Save File As” dialog window may not show up immediately for the camera needs some time to process the log data.

User Information

To edit the user information settings, select **System > View Information > User Information**.

The administrator can view the privileges of each user (refer to [Security, p. 38](#)). User lines follow this syntax:

```
<User name>: <I/O access>:<camera control>:<talk>:<listen>
```

Example: <main-entrance>: 1:1:0:1

Values for <I/O access>, <camera control>, <talk>, and <listen>:

- 1: function allowed
- 0: function blocked

NOTE! The talk and listen privileges will be set regardless of the audio capabilities of the camera.

Parameters

To edit the parameters settings, select **System > View Information > Parameter**.

Click on this item to view the parameter settings of the entire system, such as Camera Settings, Mask Information and Network Information.

Factory Default

To edit the factory default settings, select **System > Factory Default**.

You can follow the instructions on this page to reset the camera to factory default settings if needed.

Full Restore

Click on **Full Restore** to recall the factory default settings. The camera system will restart in 30 seconds. The IP address will be restored to default. After the camera system is restarted, reconnect the camera using the default IP address. The default IP address is 192.168.0.250.

Partial Restore

Click on **Partial Restore** to recall the factory default settings (excluding network settings). The camera system will restart in 30 seconds. Refresh the browser page after the camera system is restarted.

NOTE! The IP address will not be restored to default.

Reboot

Click on **Reboot** and the camera system will restart without changing the current settings. Refresh the browser page after the camera system is restarted.

Software Version

To see the software version, select **System > Software Version**.

Software Upgrade

To edit the software upgrade settings, select **System > Software Upgrade**.

NOTE! Make sure the upgrade software file is available before carrying out software upgrade.

The procedure of software upgrade is as below.

1. Click on **Browse** and locate the upgrade file, for example, “ulmage_userland”.

NOTE! Do not change the name of the upgrade file, or the system will fail to find the file.

2. Pick a file type from the drop-down menu. In this case, select “ulmage+userland.img”.
3. Click on **Upgrade**. Then the system will prepare to start the software upgrade. Subsequently, an upgrade status bar will be displayed on the page to show the current upgrade process. After the upgrade process is finished, the viewer will return to the **Home** page.
4. Close the video browser.
5. Click on **Start** and activate the **Control Panel**. In the appeared window, double-click on **Add or Remove Programs**. A window with the **Currently install programs** list will pop up. In the list, select the viewer and click on **Remove** to uninstall the existing program.
6. Open a new web browser and re-login the camera. Users will be prompted to download the viewer. Once the viewer is downloaded and installed, the live video will be available.

Maintenance

To edit the maintenance settings, select **System > Maintenance**.

You can export configuration files to a specified location and retrieve data by uploading the configuration file to the camera.

Export Files

You can save the system settings by exporting a configuration file (.bin) to a specified location for future use. Click on **Export**, and the popup File Download window will come out. Click on **Save** and specify a desired location for saving the configuration file.

Upload Files

To upload a configuration file to the camera, click on **Browse** to select the configuration file and then click on **Upload** for uploading.

The “Streaming” Tab

The **Streaming** tab contains the following sections:

Video Configuration, Video Rotation, Video Text Overlay, Video OCX Protocol, and Audio.

To edit the video configuration settings, select **Streaming > Video Configuration**.

The screenshot displays the 'Video Configuration' interface for the MOBOTIXMOVE system. The top navigation bar includes 'Home', 'System', 'Streaming' (the active tab), 'Camera', 'PTZ', and 'Logout'. A language dropdown is set to 'English'. On the left, a sidebar lists menu items: 'Video Configuration', 'Video Rotation', 'Video Text Overlay', 'Video OCX Protocol', and 'Audio'. The main content area is titled 'Video Configuration' and shows settings for four streams. Stream 1 has Encoding set to 'Yes', Encode Type 'MJPEG', Resolution '1920 x 1080', Q Factor '35', and Framerate '20'. Stream 2 has Encoding 'Yes', Encode Type 'H.264', Resolution '640 x 480', Rate Control 'VBR', Profile 'Main profile', Framerate '25', Bitrate '4096', and GOV Length '50'. Stream 3 and Stream 4 both have Encoding set to 'No'. At the bottom right, there are 'Save' and 'Reset' buttons.

NOTE!

- Only the administrator can access the **Streaming** configuration page.
- The preset resolution and other settings will vary depending on the current camera model.

Video Configuration

To edit the video configuration, select **Streaming > Video Configuration**.

Encoding

Select **Yes** from the drop-down menu to enable Stream 2~Stream 4 encoding. Or select **No** to disable the streaming encoding.

Encode Type

The available video resolution formats include H.265, H.264, and MJPEG. You can select the preferred encode type from the drop-down menu.

Default Resolution

The following table lists the default resolution of the camera.

IP Camera Model		Default Resolution
3MP Speed Dome IR Light Camera Mx-SD1A-340-IR	WDR on/off	H.265/H.264: 2065 × 1533 (30 fps) + MJPEG: 1080 × 720 (30 fps)

NOTE! The maximum resolution of the camera can only be achieved when using **H.264/H.265** as encoding. When using **MJPEG** encoding, the **maximum resolution is limited to 1920 ×1080 pixels**.

Frame Rate

Video frame rate is for setting the frames per second (fps) if necessary.

The default setting of Stream 1 is 30 fps (NTSC) or 25 fps (PAL). The maximum frame rate range of each stream will change according to the selected video resolution.

NOTE! Low frame rate will decrease video smoothness.

Profile

NOTE! Please make sure the higher compression ratio is supported by the system before setup.

Rate Control

The following H.265/H.264 bit rate modes are supported:

- **CBR (Constant Bit Rate)**

The sent-out video bit rate will be fixed and consistent to maintain the bandwidth.

- **VBR (Variable Bit Rate)**

Video bit rate varies according to the activity of the monitoring environment to achieve better image quality.

■ **LBR (Low Bit Rate)**

LBR keeps low bit rate and ensures superior image quality. To implement LBR control, setup the compression level and dynamic GOV for each streaming accordingly beforehand.

■ **Compression**

Based on the current application area and streaming bit rate, select the most suitable compression level, high/mid/low.

- Set **High**, and bit rate will vastly be reduced; however, image quality may be degraded at the same time.
- Set **Low**, and bit rate will stably keep low while image quality remains high.

■ **Dynamic GOV**

According to the amount of motion in the application area, the GOV length of the video will be adjusted dynamically to reduce more bit rate, especially for scenes with minor changes. The length of Dynamic GOV is from **GOV Length** to **Max. GOV** (4094).

- Select **Enabled** and set **Max. GOV**. Then, click on **Save** to activate the setting.
- If there is small or zero activity in the scene, set **Max. GOV** larger, the GOV length will be longer, resulting in lower bit rate and bandwidth.
- If there are constant dynamic changes in the scene, it is suggested just adjust **GOV Length** and disable **Dynamic GOV**.

Click on **Save** to confirm the setting.

Bit Rate

The default setting of the H.265/H.264 bit rate for Stream 1/2 is 4096 kbit/s; for Stream 3/4 is 2048 kbit/s. The setting range is from 64 to 20480 kbit/s, and the total bit rate should not exceed 26624 kbit/s.

GOV Length

You can set the GOV length to determine the frame structure (I-frames and P-frames) in a video stream to save bandwidth. Less bandwidth is needed if the GOV length is set to a high value. However, the shorter the GOV length, the better the video quality is.

The default setting for the available streams is 50. The setting range of the GOV length is from 1 to 4094.

Q (Quality) Factor (MJPEG Only)

The default setting of MJPEG Q factor is 35; the setting range is from 1 to 70.

BNC Support

The **BNC Support: (Yes/No)** item indicates whether the current resolution combination supports BNC output.

If users want to check the camera view via connecting a BNC monitor, please configure the stream/resolution settings as below:

Stream	Resolution
Single Stream	All available resolutions of Stream 1
Dual Stream	(1) Stream 1 = Stream 2 or (2) Stream 2 \leq D1
Triple Stream	Stream 1 = Stream 2 = Stream 3
Quad Stream	Stream 1 = Stream 2 = Stream 3 = Stream 4

Video Rotation

Rotate Function

You can change video display type if necessary. Selectable video rotate types include Mirror video and 90/180/270 degree clockwise rotate. Refer to the following descriptions for the different video rotate type.

- **Mirror**

Select **yes** from the drop-down menu, and the image will be rotated horizontally.

- **Rotate Type**

You can choose 0, 90, 180, or 270 degree from the drop-down menu to rotate the image.

Click on **Save** to confirm the setting.

Video Text Overlay

You can select the items to display data including date & time/text string/subtitle/image on the live video pane.

Overlay Type

You can select at most three items out of four options including date & time/text string/subtitle/image to display on the live video pane.

- **Include Date & Time**

Check the box to enable date & time display on the Live Video Pane and a Video Text Overlay Window will show up. Move the mouse cursor to the center of the window then click and drag the window to preferred display position. You can choose to display date, time, or date & time from the drop-down menu, and decide the string align position (left/right).

■ **Include Text String**

Check the box to enable text string display on the Live Video Pane and a Video Text Overlay Window will show up. Move the mouse cursor to the center of the window then click and drag the window to preferred display position. Type the text to display in the entry field and decide the string align position (left/right). The maximum length of the text string is 15 alphanumeric characters.

■ **Include Subtitle**

Check the box to enable subtitle display on the Live Video Pane and a Video Text Overlay Window will show up. Move the mouse cursor to the center of the window then click and drag the window to preferred display position. Type the text to display in the entry field and decide the string align position (left/right). You can set at most 5 subtitles, and the maximum length of each subtitle is 16 alphanumeric characters.

■ **Include Image**

Check the box to enable image display on the Live Video Pane and a Video Text Overlay Window will show up. Move the mouse cursor to the center of the window, click and drag the window to preferred display position, and then decide the string align position (left/right).

Click on **Set** to confirm the setting.

Text Overlay Setting

You can choose the Text Overlay Color (black, white, yellow, red, green, blue, cyan, or magenta) and Text Overlay Size (small, medium, or large) of the display date & time/text string/subtitle.

Click on **Set** to confirm the setting.

Image Overlay Setting

Users must save the image as a 8-bit BMP file; the length should be the multiple of 32, and the width should be the multiple of 4. The maximum resolution of the image should not exceed 32768 pixels.

Click on **Set** and **Upload** to confirm the setting.

Video OCX Protocol

To edit the video OCX protocol settings, select **Streaming > Video OCX Protocol**.

In the **Video OCX protocol** setting page, the administrator can select RTP over UDP, RTP over RTSP (TCP), RTSP over HTTP or MJPEG over HTTP, for streaming media over the network. In the case of multicast networking, you can select the Multicast mode. Click on **Save** to confirm the setting.

Video OCX protocol setting options include:

- **RTP over UDP/RTP over RTSP(TCP) / RTSP over HTTP/MJPEG over HTTP**
- **Multicast Mode**

Enter all required data, including **Multicast Stream 1~4 Video Address/Multicast Stream Audio Address, Multicast Port** and **Multicast TTL** into each blank.

Click on **Save** to confirm the setting.

Audio (Audio Mode and Bit Rate Settings)

To edit the audio mode settings, select **Streaming > Audio**.

In this page, the administrator can adjust the sound transmission mode, the audio gain levels and the audio bit rate. Setting for enabling sound recording to the microSD/SD card is also available.

Transmission Mode

- **Full-duplex (Talk and Listen simultaneously)**
In the Full-duplex mode, the local and remote sites can communicate with each other simultaneously, i.e. both sites can speak and listen to the other side at the same time.
- **Half-duplex (Talk or Listen, not at the same time)**
In the Half-duplex mode, the local/remote site can only talk or listen to the other site at a time.
- **Simplex (Talk only)**
In the Talk only Simplex mode, the local/remote site can only talk to the other site.
- **Simplex (Listen only)**
In the Listen only Simplex mode, the local/remote site can only listen to the other site.
- **Disable**
Select the item to turn off the audio transmission function.

Server Gain Setting

Set the audio input/output gain levels for the sound amplification. The audio input gain value is adjustable from 1 to 10. The audio output gain value is adjustable from 1 to 6. The sound will be turned off if the audio gain is set to “Mute”.

Bit Rate

Selectable audio transmission bit rate include 16 kbit/s, 24 kbit/s, 32 kbit/s, 40 kbit/s, uLAW (64 kbit/s), ALAW (64 kbit/s), AAC (128 kbit/s), PCM (128 kbit/s), PCM (256 kbit/s), PCM (384 kbit/s), and PCM (768 kbit/s). Higher bit rate will let higher audio quality and require bigger bandwidth. Click on **Save** to confirm the setting.

Input Type

Selectable input type is **Line in**. If the audio input is from the audio device connected via the Audio In connectors, users should select “Line in”. If the audio input is from the microphone connected via the Audio In connectors, users should select “External Mic” for better sound quality. Click on **Save** to confirm the setting.

Recording to Storage

Select **Enable** from the drop-down menu to enable audio recording with videos into the microSD/SD card or the NAS.

NOTE! If the chosen bit rate is not compatible with the player, there will only be noise instead of audio during playback.

Click on **Save** to confirm the setting.

The “Camera” Tab

The **Camera** tab contains the following sections:

- **Exposure**
- **White Balance**
- **Picture Adjustment**
- **IR Function**
- **Noise Reduction**
- **WDR Function**
- **Digital Zoom**
- **Backlight**
- **Profile**
- **TV System**

The screenshot shows the MOBOTIXMOVE web interface. At the top, there is a navigation bar with links for Home, System, Streaming, Camera (which is highlighted), PTZ, and Logout. A language dropdown menu is set to English. On the left side, a dark blue sidebar menu lists various camera settings: Exposure, White Balance, Picture Adjustment, IR Function, Noise Reduction, WDR Function, Image Stabilizer, Digital Zoom, Profile, and TV System. Below the TV System menu item, there is a sub-menu for 'WDR 2 shutt'. The main content area shows a live video stream of a train station platform with several high-speed trains. Above the video, it says 'Stream 1' and the timestamp '2022/08/03 09:16'. Below the video, there is a control panel with the following settings:

- ZOOM:** WIDE, TELE, 11x zoom (dropdown), x11
- FOCUS:** NEAR, FAR, AUTO (selected), MANUAL, ZOOM
- IRIS:** CLOSE, OPEN, RESET

On the right side of the control panel, there are several circular icons for camera functions: a downward arrow, a camera icon, a video camera icon, a square icon, a red stop icon, and a bell icon.

Exposure

To edit the exposure settings, select **Camera > Exposure**.

Exposure is the amount of light received by the image sensor. It is determined by the width of lens diaphragm opening, the shutter speed and other exposure parameters. With these items, you can define how the Auto Exposure function works. You can select one of the exposure modes according to the operating environment. Each exposure mode is specified as follows.

NOTE! The available settings and the shutter speed range will vary depending on the lens/CMOS sensor combination.

Auto Mode

- **Max Gain**

Maximum Gain can be set to reduce image noises. The Max Gain ranges from 1 dB to 24 dB, or select **Off** to disable the function. The default setting is 24 dB.

- **Auto Iris**

In this mode, the camera will automatically adjust the iris to suit the environment illumination. The minimum shutter speed can be set from 1/30 to 1/2 sec. (NTSC) or 1/25 to 1/3 sec. (PAL). AGC (Auto Gain Control) will function automatically according to the light conditions of the subject.

■ P-Iris Priority Mode

The minimum shutter speed can be set from 1/500 to 1/2 sec. (NTSC) or 1/425 to 1/3 sec. (PAL).

■ Iris Priority Mode

In this mode, it is the iris that has premier priority in control of the exposure. The range of the iris size is from 0 to 9, or select **Full open** to fully open the iris. The minimum shutter speed can be set from 1/30 to 1 sec. (NTSC) or 1/25 to 1/1.5 sec. (PAL).

■ Auto Shutter Mode

In this mode, the camera will automatically adjust the shutter speed and the iris size according to the light intensity. It is also effective if a fixed iris lens is being used. The minimum shutter speed can be set from 1/500 to 1/2 sec. (NTSC) or 1/425 to 1/3 sec. (PAL).

■ Shutter Priority Mode







In this mode, it is the shutter speed that takes the main control of the exposure. The range is configurable from 1/500 to 1/30 sec. (NTSC) or 1/425 or 1/25 sec. (PAL).

Manual Mode

With this mode, you can select the suitable shutter speed, iris size and gain value according to the environmental illumination. The shutter speed ranges from 1/10000 to 1/2 sec. (NTSC) or from 1/10000 to 1/3 sec. (PAL)

The range of the iris size is from 0 to 9, or select **Full open** to fully open the iris. The gain value range is from 1 to 9, or select **Off** to disable the function.

NOTE! The **Iris Size** setting is only available for models with Zoom Lens.

NOTE! For Motorized Lens models, the iris size setting differs. To set the iris size, click on , and the camera will auto detect the best iris size for the environment. If necessary, users still can manually adjust the iris size by selecting  and . Alternatively, click on  to reset the iris size. The iris size will be set to the largest. Then, you can manually adjust the iris size by selecting  and .

White Balance

To edit the white balance settings, select **Camera > White Balance**.

A camera needs to find reference color temperature, which is a way of measuring the quality of a light source, for calculating all the other colors. The unit for measuring this ratio is in degree Kelvin (K). You can select one of the White Balance Control modes according to the operating environment. The following table shows the color temperature of some light sources for reference.

Menu Reference

The “Camera” Tab

Light Sources	Color Temperature in K
Cloudy Sky	6,000 to 8,000
Noon Sun and Clear Sky	6,500
Household Lighting	2,500 to 3,000
75-watt Bulb	2,820
Candle Flame	1,200 to 1,500

Auto Mode

The Auto White Balance mode is suitable for environments with light source having color temperature in the range roughly from 2700K to 7800K.

ATW Mode (Auto Tracking White Balance)

With Auto Tracking White Balance function, the white balance in a scene will be automatically adjusted while temperature color is changing. The ATW mode is suitable for environments with light source having color temperature in the range roughly from 2500K to 10000K.

Smart Mode

The Smart mode is suitable for environments with one single background color which is strongly saturated, for instance, in a forest.

One Push

With One Push function, white balance is adjusted and fixed according to the scene the currently sees. This function is best for situations with minimal scene changes and continuous lighting. The function is suitable for light sources with any kind of color temperature. Follow the steps below to set the white balance.

- Point the camera to the monitoring area.
- Select **One Push** in the White Balance setting menu
- Click the  button to adjust the color tone of the live images.

NOTE! In this mode, the value of white balance will not change as the scene or the light source varies. Therefore, users might have to re-adjust the white balance by clicking the  button again when needed.

Smart Touch Mode

With Smart Touch function, you can select an area in the camera scene as the reference point for white balance. Please ensure that the background color of the selected area is white. Smart Touch function is suitable for environments with unchanged brightness level.

Manual Mode

In this mode, you can manually adjust the White Balance value. Input a number between 0 to 249 for “Rgain/Bgain” to adjust the red/blue illuminant on the Live Video Pane. The following describes several situations that might occur during the White Balance manual adjustment.

- The video image turns reddish (as the left picture below).

The higher the Rgain value, the redder the image will be. To solve the problem, reduce the Rgain value, and the video image will turn less reddish.



Reddish Image



Corrected White Balance

- The video image turns greenish (as the left picture below).

The lower the Rgain value, the greener the image will be. To solve the problem, Increase the Rgain value, and the video image will turn less greenish.



Greenish Image



Corrected White Balance

- The video image turns bluish (as the left picture below).

The higher the Bgain value, the bluer the image will be. To solve the problem, reduce the Bgain value, and the video image will turn less bluish.



Bluish Image



Corrected White Balance

Menu Reference

The “Camera” Tab

- The video image turns yellowish (as the left picture below).
The lower the Bgain value, the yellower the image will be. To solve the problem, Increase the Bgain value, and the video image will turn less yellowish.



The following image displays the general color shifts of the scene when different Rgain/Bgain combinations are applied.



Picture Adjustment

To edit the picture adjustment settings, select **Camera > Picture Adjustment**.

Brightness

The brightness level of the images is adjustable from -12 to +13. The default value is 0.

Sharpness

The sharpness level of the images is adjustable from +0 to +15. The edge of the objects is enhanced as the sharpness level increases. The default value is +4.

Contrast

The contrast level of the images is adjustable from -6 to +19. The default value is 0.

Saturation

The saturation level of the images is adjustable from -6 to +19. The default value is 0.

Hue

The hue level of the images is adjustable from -12 to +13. The default value is 0.

IR Function

To edit the IR function settings, select **Camera > IR Function**.

Day/Night Function

This item is for users to define the action of the IR cut filter and IR LED lights. Refer to the descriptions of each option below to select a suitable mode.

- **Auto Mode**

With this mode, the camera will decide when to remove the IR cut filter. Please refer to [Day/Night Threshold, p. 98](#) for further details.

- **Night Mode**

Use this mode when the environment light level is low. The IR cut filter will be removed to allow the camera to deliver clear images in black and white.

- **Day Mode**

Select this mode to turn on the IR cut filter. The IR cut filter can filter out the IR light and allows the camera to deliver high quality images in color.

- **Smart Mode**

With Smart mode, the camera will decide the occasion to remove the IR cut filter. The Smart mode mechanism can judge whether the main light source is from IR illumination. If so, the IR cut filter will be kept removed (i.e. monochrome/night mode).

NOTE! It is recommended to select “Smart Mode” when the camera sets high zoom ratio for close-up view.

- **Light Sensor Mode (Default)**

In this mode, for cameras with built-in IR LED modules, the light sensor will decide the occasion to turn the IR LED lights on/off. For cameras with non-IR modules, the light sensor will decide the occasion to take the IR cut filter on/off.

- **Light On Mode (Built-in IR LED Modules Only)**

In this mode, IR LED lights will always be on.

- **Light Off Mode (Built-in IR LED Modules Only)**

In this mode, IR LED lights will always be off.

Day/Night Threshold

This item is for users to set when the camera should switch from day mode to night mode or vice versa. The camera will sense the surrounding brightness, and the threshold value stands for the level of the light. Once the camera detects the light level reaches the set threshold, the camera will automatically switch to Day/Night Mode. The range of the level is from 0 to 10, (darker = 0; brighter = 10).

- **Night Mode to Day Mode** 

The lower the value, the earlier the camera switches to Day mode. The default value is 7.

- **Day Mode to Night Mode** 

The higher the value, the earlier the camera switches to Night mode. The default value is 3.

NOTE! Equipped with different CMOS sensors, the time the camera switches to Day/Night mode may also vary from models to models even if the threshold is set to the same value.

IR Light Compensation

With the IR Light Compensation function, the camera can prevent the center object close to the camera from being too bright when IR LED lights are turned on.

NOTE! IR Light Compensation function is **NOT** available when **Auto Exposure Window Setting** function is enabled.

Noise Reduction

To edit the noise reduction settings, select **Camera > Noise Reduction**.

The camera provides multiple **Noise Reduction** options for delivering optimized image quality especially in extra low-light conditions.

3DNR

3DNR (3D Noise Reduction) function delivers optimized image quality especially in extra low-light conditions.

Different levels of 3DNR are provided, including 3DNR Low, 3DNR Mid and 3DNR High. Higher level of 3DNR generates relatively enhanced noise reduction.

2DNR

2DNR (2D Noise Reduction) function delivers clear images without motion blurs in extra low-light conditions.

Select **on** to turn on 2DNR function; otherwise, select **off** to turn off 2DNR function.

ColorNR

In a dark or insufficient light environment and the camera is under color mode, ColorNR (Color Noise Reduction) can eliminate color noise.

Three levels of ColorNR, including Color Low, Color Mid and Color High, are provided. The higher level of ColorNR generates relatively enhanced noise reduction.

WDR Function

To edit the WDR settings, select **Camera > WDR Function**.

The Wide Dynamic Range (WDR) function is for solving high contrast or changing light issues to enhance video display quality. Different level options for WDR include Low, Mid and Hi. Higher level of WDR represents wider dynamic range, so that the camera can catch a greater scale of brightness.

Digital Zoom

To edit the digital zoom settings, select **Camera > Digital Zoom**.

The digital zoom of the camera is adjustable from x2 to x10.

Backlight

To edit the backlight settings, select **Camera > Backlight**. Backlight function is NOT available when TV system is set as “WDR 2 Shutter”.



The Backlight Compensation function prevents the center object from being too dark in surroundings where excessive light is behind the center object. Select **on** to turn on the function; otherwise, select **off** to turn off the function.

Profile

To edit the camera profile settings, select **Camera > Profile**.

Camera Profile allows users to setup the desired image parameters for specific environments with different time schedules. You can setup at most 10 sets of camera parameter configuration under the Camera tab. To enable this function, users must setup the schedules in advance. Refer to section Schedule for further details of schedule setup. Then, follow the steps below to setup a camera profile.

Camera Profile Setup

1. In the “Camera” tab, setup the camera parameters, such as White Balance, Picture Adjustment, etc., excluding TV System.
2. Click on Profile and its setting menu will be displayed. Select a number from the Num drop-down menu.
3. Input a name for the profile in the Name field.
4. Click on  below the Name field. The camera configuration is saved and applied to the profile. Now a camera profile is created and saved.
5. Select a profile from the Num drop-down menu.
6. Tick the By schedule box. Check the desired schedule(s) from the Schedule drop-down menu. Multiple schedules can be applied to one profile.
7. Click on  below **By schedule**.
8. Follow the steps above to set the rest of the profiles.

Now, the camera will automatically switch profiles according to the schedule. Alternatively, manually select a number from the Num drop-down menu. Then, click on , the camera will load and apply the setting of the profile.

NOTE! If users wish to set the camera parameters to factory default setting, select **Normal** from the Num drop-down menu. The camera will start loading the default values.

NOTE! Users MUST set the camera parameter of the last profile as the default setting. Thus, if there are gaps among schedules, the camera will apply the setting of the last profile.

TV System

To edit the TV system settings, select **Camera > TV System**.

Select the video format that matches the present TV system from the drop-down menu. The following table shows the available video formats for different types of models. The supported video formats for each model are marked by “√”.

Video Format		3MP Speed Dome IR Light Camera
NTSC	30 fps	√
	WDR 2 Shutter	√
PAL	25 fps	√
	WDR 2 Shutter	√

The “PTZ” Tab

The **PTZ** tab contains the following sections:

Preset, Cruise, Auto Pan, Sequence, Home Function, Tilt Range, Privacy Mask, PTZ Setting, RS485.

The screenshot shows the MOBOTIXMOVE web interface. At the top, there is a navigation bar with 'Home', 'System', 'Streaming', 'Camera', 'PTZ', and 'Logout'. A language dropdown is set to 'English'. On the left, a vertical menu lists various PTZ functions: Preset, Cruise, Auto Pan, Sequence, Home Function, Tilt Range, Privacy Mask, PTZ Setting, and RS485. The 'Preset' section is active, showing 'Preset setting' with 'PrePage' and 'NextPage' buttons, a 'Num(1~10):' dropdown set to '1', a 'Name:' input field, and 'Set' and 'Delete' buttons. Below this is the 'Preset go' section with a 'Presetlist' dropdown. To the right is a live video feed of a train station. Below the video feed are control buttons for 'ZOOM' (WIDE, TELE, 11x zoom, x11), 'FOCUS' (NEAR, FAR, AUTO, MANUAL, ZOOM), and 'IRIS' (CLOSE, OPEN, RESET).

Preset

To edit preset points, select **PTZ > Preset**.

The camera supports up to 256 preset points. Please refer to the instructions below to set a preset point.

Preset Setting

Follow the steps to set up a preset point.

1. Move the cursor to the live view pane.
2. Left click and drag the red pointer with the PTZ controls to a desired position and adjust the fine zoom/focus ratio.
3. Assign a number for the current position from the drop-down Number list (click **PrePage** or **NextPage** button to reach number 1 to 256), and enter its descriptive name.
4. Click **Set** to save the settings.

Preset Go

To have the camera move to a specified preset position, select the preset point from the Preset list (click **PrePage** or **NextPage** button to reach preset number 1 to 256). The camera will move to the target position.

Cruise

To edit cruise programming, select **PTZ > Cruise**.

The camera supports up to eight cruise paths. Please follow the instructions below for cruise path setup.

Cruise Setting

Refer to the steps below to set up a cruise path.

1. Select a path number from the drop-down list.
2. Move the cursor to the live view pane, and move the camera to a desired view (PTZ controls) as the start point of a Cruise Path.
3. Click **Set** button of **Record Start** and start programming the Cruise Path via PTZ controls.
4. When finishing programming, click the **Set** button of **Record End** to complete recording the Cruise Path.

Cruise Run

Select the specified cruise path from the drop-down list, click the **Run** button, and the camera will start touring around as recorded.

To view the camera touring in full screen mode, move the cursor onto the live view pane, right-click and left-click to select **Fullscreen**. Then you can view the camera navigation in full screen.

To stop a cruise path, simply move the cursor to the live view pane and move the camera in any direction.

Auto Pan

To edit auto pan programming, select **PTZ > Auto Pan**.

The camera supports up to four Auto Pan paths. Please refer to the instructions below to set an Auto Pan path.

Auto Pan Setting

Follow the steps to set up an Auto Pan path.

1. Select a path number from the drop-down list.
2. Select the speed ratio from the **Speed** drop-down list; the speed ratio ranges from 0 (low) to 3 (fast).
3. Choose to run the auto pan path in right/left direction from the **Direction** drop-down list.
4. Move the cursor to the live view pane, and move the camera to a desired view as the Start Point of an auto pan path.
5. Click **Set** button of **Start Point** and the current view will be automatically saved as the start point of the auto pan path.
6. Move the camera to another desired position as the end point of the auto pan path.
7. Click **Set** button of **End Point** to save the setting.

NOTE! The zoom ratio of an auto pan’s start point remains the same throughout the path.

Auto Pan Run

Select the specified auto pan path from the drop-down list, click the **Run** button, and the camera will start moving horizontally as recorded.

To view the camera panning in full screen mode, move the cursor onto the live view pane, right-click and left-click to select **Fullscreen**. Then you can view the camera navigation in full screen.

To stop running an auto pan path, simply move the cursor to the live view pane and move the camera in any direction.

Sequence

To edit sequence line programming, select **PTZ > Sequence**.

The camera supports up to eight sequence lines; each sequence line consists of up to 64 Preset points. Please refer to the instructions below to program a sequence line.

NOTE! Before setting this function, users must pre-define at least two Preset points.

Sequence Settings

Click the **Edit** button of **Sequence Setting** to enter the menu.

- **Sequence Line**

Select the number of sequence lines to be set from the drop-down list in the top of the Sequence Setting menu.

- **Sequential Preset Points**

Set up each preset point of the programmed sequence line in order. Select a preset point from the **Name** list for the specified number of preset points and enter both Dwell Time (0 to 127) and Speed (0 to 14) into the corresponding fields. When finishing the sequential setting of preset points, click the **Save** button in the top of the Sequence setting menu.

Sequence Run

Select the specified sequence line from the drop-down list, click the **Go** button, and then the camera will start moving forward each scene sequentially as programmed.

To view the camera executing a sequence line in full screen mode, please move the cursor onto the live view pane, right-click and left-click to select **Fullscreen**. Then you can view the camera navigation in full screen.

To stop running the sequence line, simply move the cursor to the live view pane and move the camera in any direction.

Home Function

To edit the Home settings, select **PTZ > Home Function**.

You can set an operation mode to ensure constant monitoring. If the camera idles for a period of time, the selected function will be activated automatically; this is the Home function. The Home function allows constant and accurate monitoring to avoid the camera idling or missing events.

Home Setting

- **Switch**

Select **On** or **Off** to activate or disable the Home function. Then click the **Set** button to apply the setting.

- **Time**

Time in this context represents the duration of camera idle time previous to running a preset point/cruise line/auto pan path/sequence line. When the Home function is activated, the camera will start to count down when it idles, and then execute the predefined action as time expires. The time period ranges from 1 min. to 128 min.; specify it in the field.

Click **Set** to save the settings.

- **Type & Line**

Select a Home action type (Preset Point/Cruise Line/Auto Pan Path/Sequence Line) and specify the number of preset points/cruise lines/auto pan paths/sequence lines from the drop-down **Type** and **Line** lists.

Click **Set** button to save the Home settings.

Tilt Range

To edit the tilt range settings, select **PTZ > Tilt Range**.

The camera’s tilt angle is adjustable from minimum -20° to maximum $+100^{\circ}$. Enter the desired minimum and maximum tilt angles into the corresponding fields.

Click **Set** button to save the tilt angle settings.

Privacy Mask

To edit privacy masks, select **PTZ > Privacy Mask**.

The Privacy Mask function aims to avoid any intrusive monitoring. When setting a mask, it is suggested to set it at least twice bigger (height and width) than the masked object. The camera will assume the center of the selected view as the starting point. It is therefore advisable to keep the target object/region nearly positioned in the center of the scene.

Mask Setting

- **Switch**

Select **On** or **Off** to activate or disable the Privacy Mask function. Click **Set** button to apply the setting.

- **Color**

Select a color from the **Color** drop-down list for the specified Privacy Mask. Click **Set** button to apply the setting.

- **Mask Number (1~20)**

Specify the number of the programmed privacy mask in the entry field.

■ Zoom Factor

Normally, a privacy mask will be repositioned and resized to cover the masked area whenever pan/tilt/zoom functions are used. The zoom factor allows users to hide the mask if the zoom ratio is set lower than the original ratio.

For example, when the privacy mask is set at a certain zoom ratio (e.g. 5x), the privacy mask will be resized when the camera is zoomed in (e.g. from 5x to 20x); however, when the camera zooms out (e.g. from 5x to 2x), the privacy mask will be hidden. Select **On** or **Off** to activate or disable the Zoom Factor function. Follow the steps below to set up a privacy mask.

1. Set Switch to **On** and click the **Set** button to turn on the Privacy Mask function.
2. Select a color for the mask from the **Color** drop-down list and click the **Set** button to apply the color setting.
3. Specify the mask a number, e.g. 17. If Zoom Factor is needed, select **On** to enable this function. Then, click the **Add** button and a privacy mask will be displayed on the Live Video Pane on the right.
4. To shift the mask to the intended location, move the mouse cursor to the center of the mask and click and drag.
5. To change the shape and the size of the mask, click any edge of the mask and draw it outward/inward.
6. If needed, set up Zoom/Focus/Iris.
7. Click **Set** button to save and apply the setting. The privacy mask will be displayed in the color set previously.

If you want to edit the previously-set mask, input the mask number in the Mask(1~20) entry field and click the **Edit** button. The camera will go to the set location and display the mask. You can then follow Steps 4 to 6 to edit the mask.

To cancel mask editing, just click the **Return** button to exit the editing.

Mask Clearing

To delete an existing privacy mask, select it from the drop-down list and click the **Clear** button. The selected privacy mask will disappear.

PTZ Setting

To edit the PTZ settings, select **PTZ > PTZ Setting**.

Flip (Image Flip)

You can track an object continuously when it passes under the camera by setting **Flip** to **M.E. Mode** (mechanical mode) or digital flip **Image Mode**:

- **M.E. Mode**

M.E. is a standard mechanical operation. As the camera tilts to the maximum angle, it will pan 180°, and then continue tilting to keep tracking objects.

- **Image Mode**

The digital image flip mode allows tracking the objects seamlessly. Compared to **M.E. Mode**, there is hardly any perceptible delay.

NOTE!

- The **Flip** setting is only controlled manually. If a preset position or a point for other function (e.g. a sequence) is set in the position that can only be reached through FLIP motion, when the Flip function is turned off, the position cannot be reached anymore.
- To make the camera tilt between a specific range, such as -10° to +100° or -10° to +190°, please go to the **Tilt Range** setting page to set the tilt angle range. Otherwise, the camera will tilt 90° as the default setting.

Save

Click on **Save** to keep the settings.

RS485

To edit the RS485 settings, select **PTZ > RS485**.

RS-485 Protocol Type

With the correct RS-485 protocol selected, you can remotely control the PTZ function of the camera using a joystick or keyboard.

Select the proper RS485 protocol for your joystick/keyboard from the drop-down list:

- DSCP
- PelcoD
- PelcoP

After selecting the protocol type, you can adjust the parameters from the drop-down lists on the right.

Save

Click on **Save** to keep the settings.

The “Logout” Tab

Click on the tab **Logout** on the top of the page, and the login window will pop up. This enables logging in with a different username.

Appendix A: Installing UPnP Components

Please follow the instructions below to install UPnP components on Windows computers.

1. In Windows, go to **Start**, click on **Control Panel**, and then double-click on **Add or Remove Programs**.
2. Click on **Add/Remove Windows Components** in the **Add or Remove Programs** page.
3. Select **Networking Services** from the Components list in Components Wizard window of the Windows, and then click **Details**.
4. Select **UPnP User Interface** in the Networking Services’ subcomponents list and then click on **OK**.
5. Click on **Next** in the Windows Components Wizard window.
6. Click on **Finish** to complete installation.

Appendix B: Converting IP Addresses from Decimal to Binary

Follow the example below to convert the IP addresses to binary numbers. Use the calculator on the computer for conversion: **Start > All Programs > Accessories > Calculator**.

- Windows 7/8: Click **View** on the calculator and click **Programmer**.
- Windows 10/11: Click on the menu button  and select **Programmer**.

The example below shows how to convert 192.168.2.81 to binary numbers.

1. On the left of the calculator, select **Dec**. Then enter the first decimal number of the IP address, “192”. Select **Bin** and the number will be converted to binary number. Repeat the same procedure with the rest of decimal numbers. Remember to select **Dec** before entering the next decimal number. Otherwise a decimal number cannot be entered. The table below shows the binary representation of each decimal number.

Decimal Numbers	Binary Numbers
192	11000000
168	10101000
2	10
81	1010001

2. Each binary number should have eight digits. If a binary number does not have eight digits, please add leading zeros until it does. The binary number of each decimal number should be as follows.

Decimal Numbers	Binary Numbers
192	11000000
168	10101000
2	00000010
81	01010001

Therefore, the binary representation of IP address 192.168.2.81 is

11000000.10101000.00000010.01010001.

Technical Support Information

This section contains the following information:

Technical Specifications	112
---------------------------------------	------------

Technical Specifications

Remotely Upgradable Firmware

The firmware of the MOBOTIX MOVE 3MP Speed Dome IR Light Camera can be upgraded remotely. This applies to the IP system and the pan/tilt/zoom block. This feature instantly adds new features and greatly reduces maintenance costs.

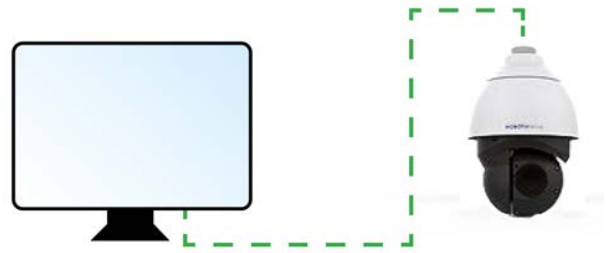

Servo Feedback

The MOBOTIX MOVE 3MP Speed Dome IR Light Camera features **Servo Feedback** technology. When encountering external force, such as vandalism or vibration, the PTZ immediately returns to its original position.



Product Information

Product Name	3MP Speed Dome IR Light Camera
Order Code	Mx-SD1A-340-IR

Image Quality

Image Sensor	3MP 1/2.8" Progressive CMOS
Effective (Used) Pixels	H x V = 2065x1553 (3MP)
Pixel Size	2.5 μm
Frame Rate (maximum)	WDR on/off: H.265/H.264: 3MP@30 fps MJPEG: 1080p@30fps

Lens

Minimum Illumination	Color: 0.04 lux B/W: 0.002 lux
Lens Characteristics	Motorized Lens: Zoom, Focus, P-IRIS, Auto-IRIS Focal Length: 4.3 to 129 mm Aperture: F1.6 Horizontal Field of View: 63.7° (Wide), 1.7° (Tele) Vertical Field of View: 49.2° (Wide), 1.3° (Tele)

Camera

Day/Night	Automatically switchable IR-cut filter
Shutter Time	1 to 1/10000 s
Shutter Priority Mode	Up to 1/45 s
WDR	Up to 120 dB
EIS	Yes
Auto tracking	On/off
Zoom	Optical: 40x, Digital 10x
Image Settings	Color, Brightness, Sharpness, Contrast, White Balance, Exposure Control, 2DNR, 3DNR, NR by Motion, Masking, Text Overlay
Image Rotation	90°, 180°, 270°
Servo Feedback	Yes (see Servo Feedback, p. 112)

Video Codec

Compression/Encoding	H.265/H.264/MJPEG
Streaming	Up to 3 individually configurable streams in H.264/H.265/MJPEG. Configurable resolution, frame rate, bandwidth LBR/VBR/CBR in H.265/H.264.

Audio Codec

Compression/Encoding	G.711/G.726/AAC/LPCM
Streaming	Two-way Configurable resolution, frame rate, bandwidth LBR/VBR/CBR in H.265/H.264.
Audio Input	Line In
Audio Output	Line Out

Cyber Security Features

Password Protection	Yes
IP address filtering	Yes
IEEE 802.1X network access control	Yes
Digest authentication	Yes
AES encryption for password protection	Yes
SNMP, TLS, HTTP, HTTPS	Yes
User and Group Management	Yes
SSL connections	Yes
VPN	Yes
Digital image signature	Yes
RSA encryption (2048 bits)	Yes

Network

Interface	10/100 Mbps Ethernet
Supported Protocols	ARP, PPPoE, IPv4/v6, ICMP, IGMP, QoS, TCP, UDP, DHCP, UPnP, SNMP, SMTP, RTP, RTSP, HTTP, HTTPS, FTP, NTP, DDNS, SMBv2
ONVIF conformance	Supports profiles S/G/T
Supported Browsers	All current browsers are supported.

System Integration

Base Video Analytics	Motion detection, audio detection
Event Triggers	<ul style="list-style-type: none"> ▪ External Input ▪ Analytics ▪ Network failure detection ▪ Periodical event ▪ Manual trigger
Event Actions	<ul style="list-style-type: none"> ▪ External output activation ▪ Video and audio recording to edge storage ▪ File upload: FTP, network share and email ▪ Notification: HTTP, FTP, email

General

Housing material	Metal and plastic
Power Requirements	Forced 4-pair UPoE, max 39.60 W AC24V, max 44.00 W, max 64.90 VA
PoE Modes Supported	Mode A and Mode B required
Connectors	<ul style="list-style-type: none"> ▪ RJ45 ▪ 4 x Alarm in, 2x Alarm out terminal block ▪ DC 12 V terminal block ▪ AC 24 V terminal block ▪ Audio In terminal block ▪ Audio Out terminal block ▪ CVBS connector (available with max. 2 activated streams) ▪ RS485 terminal block
IR Illumination	850 nm; up to 200 m distance depending on scenery reflection
Video Storage	Micro SD/SDHC/SDXC card support up to 1 TB, Support for recording to NAS, MOBOTIX MOVE NVR
Remotely Upgradable	Yes (see Remotely Upgradable Firmware, p. 112)
Environmental Protection Class	IP66/IK10 (housing only)
Operating Temperature	-55 to 55 °C/-67 to 131 °F with heater
Relative Humidity	10 to 90 % non-condensing

Technical Support Information

Technical Specifications

Storage Conditions	-20 to 70 °C/-4 to 158 °F
Approvals	EMC: CE/FCC, Safety: LVD, Environmental: IP66
Dimensions	ø 207.4 x 300.4 mm with sun shield
Weight	3400 g

PTZ Features

Preset positions	Up to 256 positions, 1 Home position
Sequences	Up to 8 sequences with 64 preset positions each
Cruise Path	up to 8
Auto pan paths	Up to 4
Display Position	Pan/Tilt degrees can be displayed in live image
Tilt Angle	Between -20° and +100°
Pan Angle	360° endless
Tilt Speed	Manual Tilt Speed: 0.1°-60°/s; Preset Tilt Speed: 7°-300°/s
Pan Speed	Preset up to 400°/s
Joystick/Keypoint Control	RS485 protocols DSCP, Pelco-D and Pelco-P

NOTE! Observe the [MOBOTIX MOVE Installation Hints](#) document to ensure optimum performance of the camera features.

MOBOTIX

BeyondHumanVision

[EN_08/22](#)

MOBOTIX AG • Kaiserstrasse • D-67722 Langmeil • Tel.: +49 6302 9816-103 • sales@mobotix.com • www.mobotix.com

MOBOTIX is a trademark of MOBOTIX AG registered in the European Union, the U.S.A., and in other countries. Subject to change without notice. MOBOTIX do not assume any liability for technical or editorial errors or omissions contained herein. All rights reserved. © MOBOTIX AG 2020