

# Technical Specifications

## MOBOTIX MOVE 2MP Vandal Dome Camera

A performant 2MP, full HD 1080p resolution camera for the daily security and surveillance needs. The camera easily adapts to different indoor and outdoor scenes.

- 2.8 to 12 mm Manual Vari-Focal Lens
- Wide Dynamic Range (WDR) max. 130 dB
- Light Sensitivity: Color 0.08 lux, B/W 0.008 lux
- PoE Power Support
- Integrated IR LEDs up to 40 m distance
- Outdoor suitable (IP66) and vandal proof design (IK10)
- ONVIF Profile S/G/T/M support
- Temperature Range -55 to 60 °C/-67 to 140 °F



## Technical Specifications

### MOBOTIX MOVE 2MP Vandal Dome Camera

---

## Product Information

Product Name	2MP Vandal Dome Camera
--------------	------------------------

Order Code	Mx-VD2A-2-IR
------------	--------------

---

## Image Quality

Image Sensor	5MP, 1/2.7" Progressive scan
--------------	------------------------------

Effective (Used) Pixels	H x V = 1920x1080 (2MP)
-------------------------	-------------------------

Pixel Size	2.0 $\mu\text{m}$
------------	-------------------

Frame Rate (maximum)	<b>WDR on:</b> H.265/H.264: 1920x1080@30fps + 720x480@30fps MJPEG: 1080p@30fps <b>WDR off:</b> H.265/H.264: 1920x1080@30fps + 720x480@30fps MJPEG: 1080p@30fps
----------------------	---

---

## Lens

Minimum Illumination	Color: 0.08 lux B/W: 0.008 lux
----------------------	-----------------------------------

Lens Characteristics	Manual Vari-Focal Lens Focal Length: 2.8 to 12 mm Aperture: F1.4 to F2.8 Horizontal Field of View: 96.76° (Wide), 34.13° (Tele) Vertical Field of View: 52.21° (Wide), 19.24° (Tele)
----------------------	--

Lens Mechanics	3-Axis adjustment
----------------	-------------------

---

## Camera

Day/Night	Automatic mechanically switchable IR-cut filter
Shutter Time	<b>Manual mode:</b> WDR: 1/17550 s Linear: 30 fps, 1/37440 s <b>Automatic Mode:</b> 1 to 1/10000 s
WDR	Up to 130 dB Multi Exposure WDR & HDR Engine support
Zoom	Optical: 4.29x, Digital: 10x
Image settings	Color, Brightness, Sharpness, Contrast, White Balance, Exposure Control, 2DNR, 3DNR, NR by Motion, Masking, Text Overlay
Corridor Mode	90°, 180°, 270° Rotation

---

## Video Codec

Compression/Encoding	H.265/H.264/MJPEG
Streaming	Up to 4 individually configurable streams in H.264/H.265/MJPEG Configurable resolution/frame rate/bandwidth LBR/ VBR/CBR in H.265/H.264

---

## Cyber Security Features

Password Protection	Yes
IP address filtering	Yes
IEEE 802.1X network access control	Yes
Digest authentication	Yes
AES encryption for password protection	Yes
SNMP, TLS, HTTP, HTTPS	Yes
User and Group Management	Yes
SSL connections	Yes
VPN	Yes

---

## Technical Specifications

### MOBOTIX MOVE 2MP Vandal Dome Camera

---

Digital image signature	Yes
RSA encryption (2048 bits)	Yes

---

## Network

Interface	10/100 Mbps Ethernet
Supported Protocols	ARP, PPPoE, IPv4/v6, ICMP, IGMP, QoS, TCP, UDP, DHCP, UPnP, SNMP, SMTP, RTP, RTSP, HTTP, HTTPS, FTP, NTP, DDNS, SMBv2
ONVIF conformance	Supports profiles S/G/T/M
Supported Browsers	All current browsers are supported.

---

## System Integration

Base Video Analytics	<ul style="list-style-type: none"><li>▪ Motion Detection</li><li>▪ Tampering</li></ul>
Event Triggers	<ul style="list-style-type: none"><li>▪ Analytics</li><li>▪ Network failure detection</li><li>▪ Periodical event</li><li>▪ Manual trigger</li></ul>
Event Actions	<ul style="list-style-type: none"><li>▪ Video recording to edge storage</li><li>▪ File upload: FTP, network share and email</li><li>▪ Notification: HTTP, FTP, email</li></ul>

---

## General

Casing	Metal Housing
Power Requirements	PoE IEEE802.3af, class 0, max. 7.5 W
PoE Modes Supported	Mode A or Mode B
Connectors	RJ45
IR Illumination	850 nm; up to 40 m distance depending on scenery reflection
Video Storage	Micro SD/SDHC/SDXC card support up to 1 TB, Support for recording to NAS, MOBOTIX MOVE NVR

---

## Technical Specifications

### MOBOTIX MOVE 2MP Vandal Dome Camera









---

Environmental Protection Class	IP66/IK10
Operating Temperature	-55 to 60 °C/-67 to 140 °F
Cold Start Temperature	-20 °C/-4 °F
Relative Humidity	10 to 90 % non-condensing
Storage Conditions	-20 to 70 °C/-4 to 158 °F
Approvals	EMC: CE/FCC, Safety: LVD, Environmental: IP66, IK10
Dimensions	ø 133.8 x 117.4 mm
Weight	760 g

---

**NOTE!** Observe the [MOBOTIX MOVE Installation Hints](#) document to ensure optimum performance of the camera features.

# Accessories

Picture	Order Code	Description
	Mx-M-VD-W	Wall Mount set (2 pieces) for MOBOTIX MOVE Vandal Dome Cameras
	Mx-M-VD-P	Pole Mount (junction mount) for MOBOTIX MOVE Vandal Dome Cameras
	Mx-M-VD-C	Corner Mount for MOBOTIX MOVE Vandal Dome Cameras
	Mx-M-VD-IC	Ceiling Flush Mount for MOBOTIX MOVE Vandal Dome Cameras
	Mx-M-VD-DCT	Clear Replacement Bubble for MOBOTIX MOVE Vandal Dome Cameras
	Mx-M-VD-DCS	Tinted (smoked) Replacement Bubble for MOBOTIX MOVE Vandal Dome Cameras
	Mx-NPA-UPOE1A-60W	UPoE Network Power Injector 60 W
	Mx-A-ETP1A-2601-SET	Media Converter Set Ethernet (PoE+) – Twisted-Pair

---

# Dimensions

**NOTE!** Download the drilling template from the section or on the MOBOTIX website: [www.mobotix.com](http://www.mobotix.com) > Support > Download Center > Marketing & Documentation > Drilling Templates.

**CAUTION!** Always print or copy the drilling template at 100% of the original size!

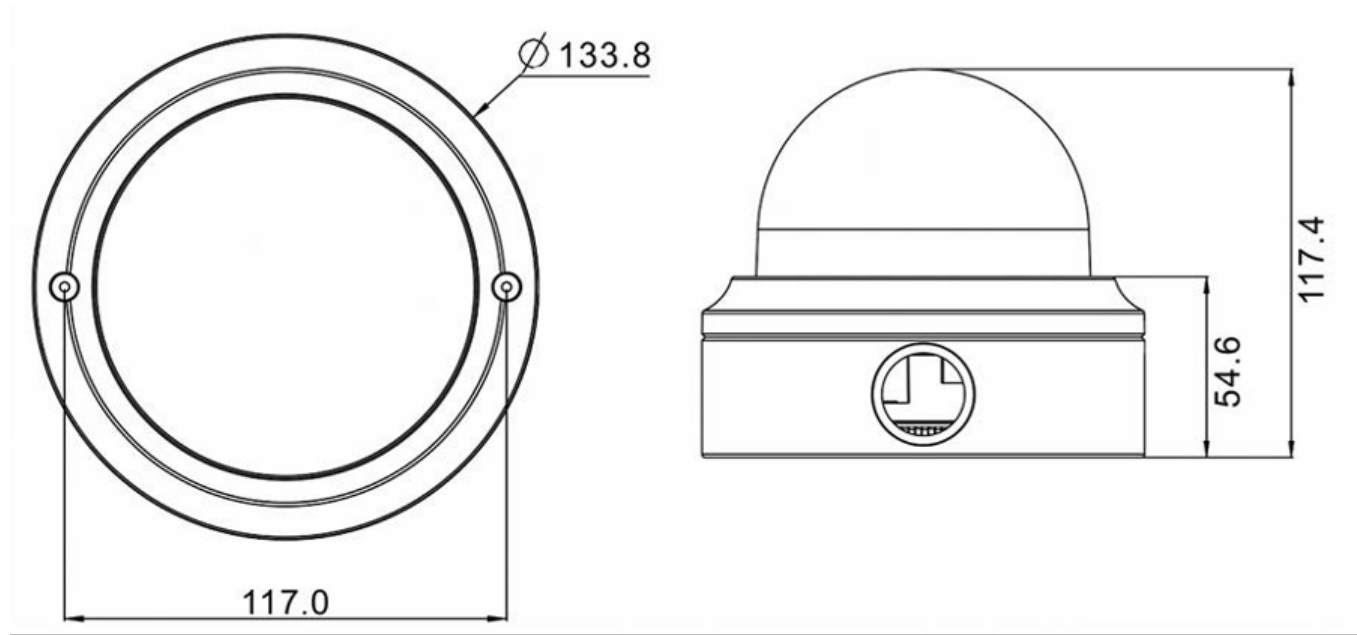

Fig. 1: 2MP Vandal Dome Camera: All measurements in mm

## Further Reading

Manuals and Quick Installation documents



Technical Specifications



MOBOTIX MOVE Installation Hints





# MOBOTIX

BeyondHumanVision

[EN\\_09/22](#)

MOBOTIX AG • Kaiserstrasse • D-67722 Langmeil • Tel.: +49 6302 9816-103 • [sales@mobotix.com](mailto:sales@mobotix.com) • [www.mobotix.com](http://www.mobotix.com)

MOBOTIX is a trademark of MOBOTIX AG registered in the European Union, the U.S.A., and in other countries. Subject to change without notice. MOBOTIX do not assume any liability for technical or editorial errors or omissions contained herein. All rights reserved. © MOBOTIX AG 2020