

Technical Specifications

MOBOTIX MOVE 5MP Vandal Fixed Dome Analytics Camera

Performant 5MP resolution camera with integrated Video Analytics features, perfect for the daily security and surveillance needs. The camera performs fast and reliable auto focus and adapts to different indoor and outdoor scenes. The MOBOTIX EverClear superhydrophilic and self-cleaning nano coating of the dome ensures best image quality even in rain and reduces cleaning efforts and operational costs.

- EverClear coating of dome
- Motorized Vari-Focal Lens 2.7 to 12 mm, F1.6 to F2.9 with Zoom and One-Push Auto Focus
- Wide Dynamic Range (WDR) max. 130 dB
- MOBOTIX MxMessageSystem communication system
- Integrated Video Analytics
- Integrated IR LEDs up to 40 m Distance
- ONVIF Profile S/G/T/M support
- Triple Power Support (PoE/12 VDC/24 VAC)
- Temperature Range -55 to 60 °C/-67 to 140 °F
- IP66 and IK10
- Quick Connection Mount



Technical Specifications

MOBOTIX MOVE 5MP Vandal Fixed Dome Analytics Camera

Product Information

Product Name	5MP Vandal Fixed Dome Analytics Camera
--------------	--

Order Code	Mx-VD2A-5-IR-VA
------------	-----------------

Image Quality

Image Sensor	5MP, 1/2" Progressive CMOS
--------------	----------------------------

Effective (Used) Pixels	H x V = 2720x1976 (5MP)
-------------------------	-------------------------

Pixel Size	2.0 μm
------------	-------------------

Frame Rate (maximum)	WDR on:
----------------------	----------------

H.265/H.264: 2688x1944@30 fps + 1024x768@30 fps

H.265/H.264: 2592x1944@30 fps + 1280x720@30 fps

H.265/H.264: 2688x1512@30 fps + 1280x1024@30 fps

H.265/H.264: 1920x1080@30 fps + 1920x1080@30 fps

MJPEG: 1080p@30 fps

WDR off:

H.265/H.264: 2688x1944@30 fps + 1024x768@30 fps

H.265/H.264: 2592x1944@30 fps + 1280x720@30 fps

H.265/H.264: 2688x1512@30 fps + 1280x1024@30 fps

H.265/H.264: 1920x1080@60 fps + 1280x1024@44 fps

H.265/H.264: 1920x1080@60 fps + 1280x720@60 fps

Stream 1 (main stream) with resolutions below 1920x1080 can support 2 streams@60 fps

MJPEG: 1080p@60 fps

Dome Coating	Superhydrophilic MOBOTIX EverClear nano coating transforms water droplets into an ultra-thin water film upon impact. The coating ensures best image quality in rain and difficult external conditions and it reduces reflections and noise in low-light scenarios. EverClear is dirt-repellent and increases the stability as well as the scratch-resistance of the dome, further reducing maintenance efforts. Coating endurance up to 3 years depending on environmental conditions and cleaning treatment.
--------------	---

MOBOTIX MOVE 5MP Vandal Fixed Dome Analytics Camera

Lens

Minimum Illumination	Color: 0.08 lux B/W: 0.008 lux
Lens Characteristics	Motorized Lens: Zoom, Focus, P-IRIS Focal Length: 2.7 to 12 mm Aperture: F1.6 to F2.9 Horizontal Field of View: 102.1° (Wide), 31.5° (Tele) Vertical Field of View: 70.3° (Wide), 22.7° (Tele)
Lens Mechanics	3-Axis adjustment

Camera

Day/Night	Automatic mechanically switchable IR-cut filter
Shutter Time	Manual Mode: WDR: up to 1/17550 s Linear: up to 1/37440 s Automatic Mode: Up to 1/10000 s
WDR	Up to 130 dB Multi Exposure WDR & HDR Engine support
Zoom	Optical: 4.4x, Digital: 10x
Image settings	Color, Brightness, Sharpness, Contrast, White Balance, Exposure Control, 2DNR, 3DNR, NR by Motion, Masking, Text Overlay
Corridor Mode	90°, 180°, 270° Rotation

Video Codec

Compression/Encoding	H.265/H.264/MJPEG
Streaming	Up to 4 individually configurable streams in H.264/H.265/MJPEG Configurable resolution/frame rate/bandwidth LBR/VBR/CBR in H.265/H.264

Technical Specifications

MOBOTIX MOVE 5MP Vandal Fixed Dome Analytics Camera

Audio Codec

Compression/Encoding	G.711/G.726/AAC/LPCM
Streaming	2-Way, bidirectional
Audio Input	Line In: Max 6.2 Vpp Signal In, Input Impedance: 33 k Ω
Audio Output	Line Out: 1 Vrms Signal Out, Output Resistance: 200 Ω

Cyber Security Features

Password Protection	Yes
IP address filtering	Yes
IEEE 802.1X network access control	Yes
Digest authentication	Yes
AES encryption for password protection	Yes
SNMP, TLS, HTTP, HTTPS	Yes
User and Group Management	Yes
SSL connections	Yes
VPN	Yes
Digital image signature	Yes
RSA encryption (2048 bits)	Yes

Network

Interface	10/100 Mbps Ethernet
Supported Protocols	ARP, PPPoE, IPv4/v6, ICMP, IGMP, QoS, TCP, UDP, DHCP, UPnP, SNMP, SMTP, RTP, RTSP, HTTP, HTTPS, FTP, NTP, DDNS, SMBv2
ONVIF conformance	Supports profiles S/G/T/M
Supported Browsers	All current browsers are supported.

System Integration

Base Video Analytics	<ul style="list-style-type: none"> ▪ Motion detection ▪ Noise detection (ext. microphone required)
Enhanced Video Analytics (embedded)	<ul style="list-style-type: none"> ▪ Abandoned objects ▪ Intrusion ▪ Sabotage ▪ Wrong direction ▪ Loitering ▪ Object counting ▪ Object removal ▪ Stopped vehicle
2 analytics functions can be activated simultaneously	
Event Triggers	<ul style="list-style-type: none"> ▪ External input ▪ Analytics ▪ Network failure detection ▪ Periodical event ▪ Manual trigger
Event Actions	<ul style="list-style-type: none"> ▪ External output activation ▪ Video and audio recording to edge storage ▪ File upload: FTP, network share and email ▪ Notification: HTTP, FTP, email

General

Casing	Metal Housing
Camera Module Adjustment	3-Axis Gimbal (Pan/Tilt/Rotate)
Device Color	<p>Metal body housing: RAL 9003</p> <p>Logo color: Pantone 286C and Pantone Gray 6 Cu</p>
Power Requirements	<p>PoE IEEE802.3af, class 0, max 12.95 W</p> <p>DC12V, max 14.88 W</p> <p>AC24V, max 15.25 W, max 26.16 VA</p> <p>Zero-Down-Time Power Source Switching</p>

Technical Specifications

MOBOTIX MOVE 5MP Vandal Fixed Dome Analytics Camera

PoE Modes Supported	Mode A or Mode B
Connectors	RJ45, Alarm in x2, Alarm out x1, 12 VDC Terminal Block, 24 VAC Terminal Block, Audio in 3.5 mm Jack, Audio out 3.5 mm Jack, CVBS Connector COAX (75 Ohm) (CVBS output available with max. 2 activated streams, requires optional adapter 2-pin COAX cable)
IR Illumination	Up to 40 m/131 ft distance depending on scenery reflection
Video Storage	Micro SD/SDHC/SDXC card support up to 1 TB, Support for recording to NAS, MOBOTIX MOVE NVR
Environmental Protection Class	IP66/IK10
Operating Temperature	-55 to 60 °C/-67 to 140 °F
Cold Start Temperature	-30 °C/-22 °F
Relative Humidity	10 to 90 % non-condensing
Storage Conditions	-20 to 70 °C/-4 to 158 °F
Approvals	EMC: CE/FCC Safety: LVD Environmental: IP66, IK10
MTBF	95,000 hours
Warranty	5 years
Dimensions	ø 133.8 x 117.4 mm
Weight	760 g

NOTE! Observe the [MOBOTIX MOVE Installation Hints](#) document to ensure optimum performance of the camera features.

Alarm Input/Output Current and Voltage









Alarm In

3.3 V with 10 k Ω pull up, 50 mA

Alarm Out

350 V DC/AC, 130 mA

Accessories

Picture	Order Code	Description
	Mx-M-VD-W	Wall Mount set (2 pieces) for MOBOTIX MOVE Vandal Dome Cameras
	Mx-M-VD-P	Pole Mount (junction mount) for MOBOTIX MOVE Vandal Dome Cameras
	Mx-M-VD-C	Corner Mount for MOBOTIX MOVE Vandal Dome Cameras
	Mx-M-VD-IC	Ceiling Flush Mount for MOBOTIX MOVE Vandal Dome Cameras
	Mx-M-VD-DCT	Clear Replacement Bubble for MOBOTIX MOVE Vandal Dome Cameras
	Mx-M-VD-DCS	Tinted (smoked) Replacement Bubble for MOBOTIX MOVE Vandal Dome Cameras
	Mx-NPA-UPOE1A-60W	UPoE Network Power Injector 60 W
	Mx-A-ETP1A-2601-SET	Media Converter Set Ethernet (PoE+) – Twisted-Pair

Dimensions

NOTE! Download the drilling template from the section or on the MOBOTIX website: www.mobotix.com > Support > Download Center > Marketing & Documentation > Drilling Templates.

CAUTION! Always print or copy the drilling template at 100% of the original size!

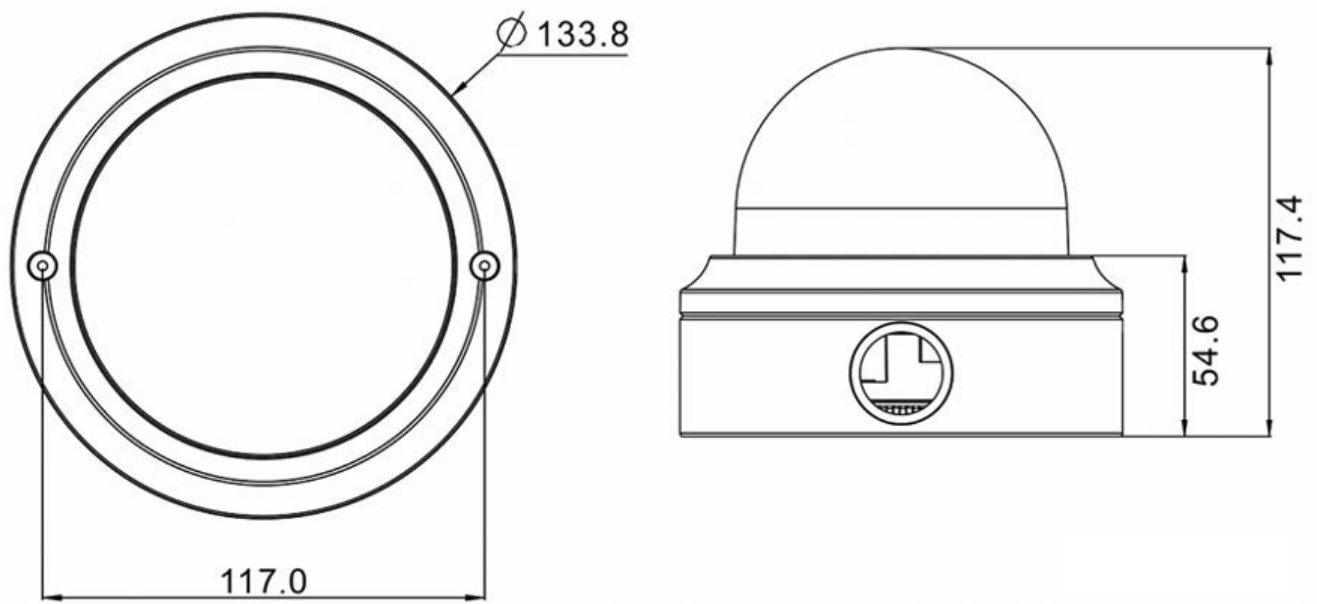

Fig. 1: 5MP Vandal Fixed Dome Analytics Camera: All measurements in mm

Further Reading

Manuals and Quick Installation documents



Technical Specifications



MOBOTIX MOVE Installation Hints



MOBOTIX

BeyondHumanVision

[EN_12/22](#)

MOBOTIX AG • Kaiserstrasse • D-67722 Langmeil • Tel.: +49 6302 9816-103 • sales@mobotix.com • www.mobotix.com

MOBOTIX is a trademark of MOBOTIX AG registered in the European Union, the U.S.A., and in other countries. Subject to change without notice. MOBOTIX do not assume any liability for technical or editorial errors or omissions contained herein. All rights reserved. © MOBOTIX AG 2020