

Quick Installation

MOBOTIX 5MP Indoor Micro Dome Camera Mx-MD1A-5-IR

© 2023 MOBOTIX AG

NOTE!

This guide is only valid for **installing and connecting** the 5MP Indoor Micro Dome Camera. For more information on the camera, please refer to the other documents (see [Further Reading, p. 7](#)).

Important Installation Notes

- This camera must be installed by qualified personnel and the installation should conform to all local codes.
- This product must not be used in locations exposed to the dangers of explosion.
- Do not look directly into the infra-red LEDs that may be active on the product.
- Do not use this product in a dusty environment.
- Protect this product from moisture or water entering the housing.
- Install this product as outlined in this document. A faulty installation can damage the product!
- Do not replace batteries of the camera. Risk of explosion may occur if the battery is replaced by an incorrect type.
- This equipment is not suitable for use in locations where children are likely to be present.
- External power supplies must comply with the Limited Power Source (LPS) requirements and share the same power specifications with the camera.
- When using a Class I adapter, the power cord shall be connected to a socket-outlet with proper ground connection.
- To comply with the requirements of EN 50130-4 regarding the power supply of alarm systems for 24/7 operation, it is highly recommended to use an uninterruptible power supply (UPS) for backing up the power supply of this product.
- This equipment is to be connected only to PoE networks without routing to other networks.

NOTE! Observe the [MOBOTIX MOVE Installation Hints](#) document to ensure optimum performance of the camera features.

Camera Connectors

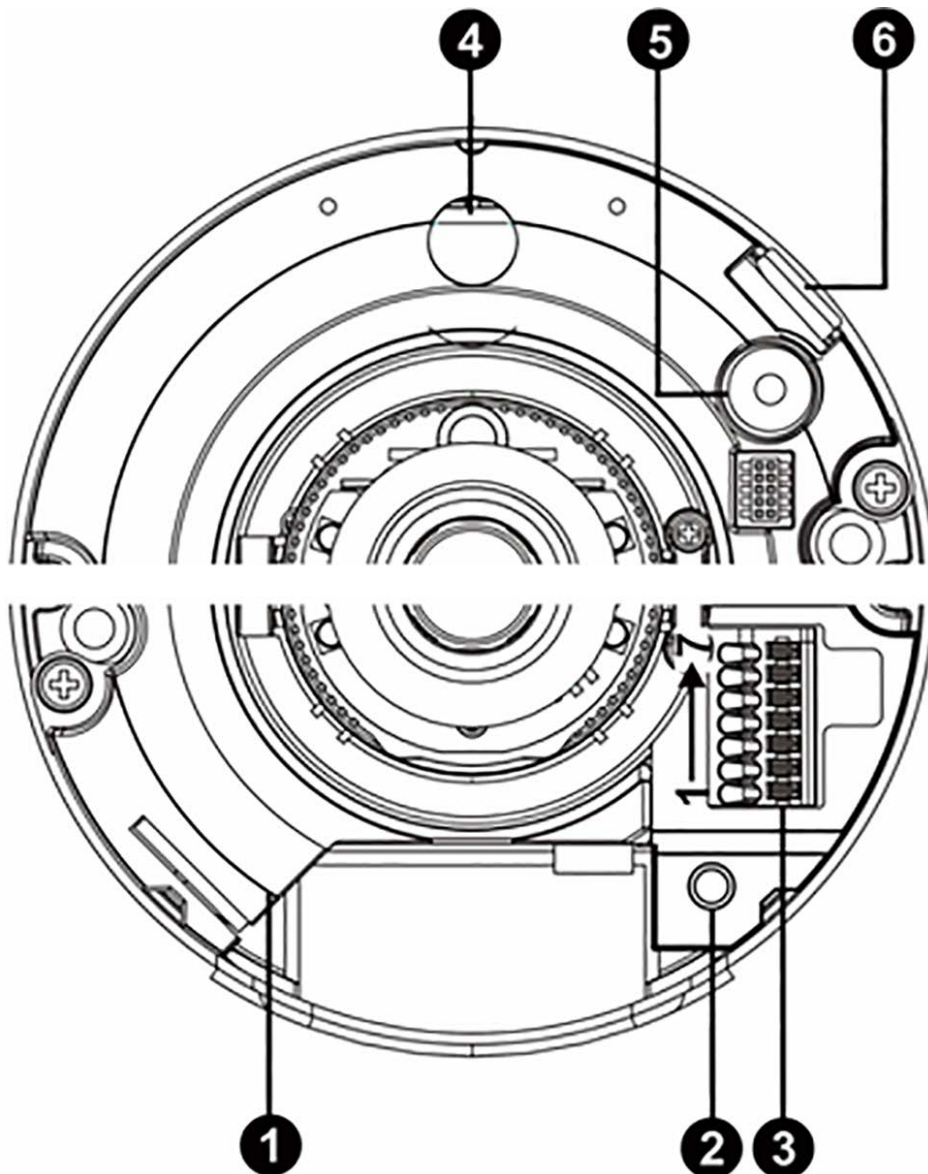

No.	Connector	Pin	Definition	Remarks
1	RJ-45	-	For network and PoE connections	
2	Reset Button	-	Press the reset button with a proper tool for at least 20 seconds to restore the factory defaults.	
3	Audio I/O	7	Audio In (Line In)	Two-way audio transmission
		6	Audio Out (Line Out)	
		5	GND	
4	Built-in Speaker	-	Audio Out	

No.	Connector	Pin	Definition	Remarks
5	Built-in Microphone	–	Audio In	
6	microSD Card Slot	–	Insert the microSD card into the card slot to store videos and snapshots. Do not remove the microSD card when the camera is powered on.	

NOTE! To avoid audio quality degradation, **do not** connect the built-in microphone and external audio-input device (via Line In) at the same time. The same applies to the audio output connections.

microSD Card Slot/Default Button

CAUTION! Always power down the camera before performing the following steps!

microSD Card Slot

Insert the microSD card into the card slot to store videos and snapshots.

NOTE!

- It is not recommended to record with the microSD card for 24/7 continuously, as it may not be able to support long term continuous data read/write. Contact the manufacturer of the microSD card for information regarding the reliability and the life expectancy.
- Remember to format a new microSD card as shown in [Formatting the SD Card](#) below.

Default Button

Press the default button with a proper tool for at least 20 seconds to restore the system.

Camera Cabling

Power Connection

Connect the Ethernet cable to the RJ-45 connector of the camera, and plug the other end of the cable to a suitable Power Sourcing Equipment (PSE) / Power over Ethernet (PoE) switch.

NOTE! If PoE is used, make sure PSE is in use in the network.

Ethernet Cable Connection

Connect one end of the Ethernet cable to the RJ-45 connector of the camera, and plug the other end of the cable to the network switch or PC.

Ethernet Cable Connection

Connect one end of the Ethernet cable to the RJ-45 connector of the camera and plug the other end of the cable into the network switch or PC.

NOTE!

- The length of the Ethernet cable should not exceed 100 m/300 ft.
- Check the status of the link indicator and the activity indicator LEDs of the switch. If the LEDs are unlit, please check the LAN connection.
- In some cases, an Ethernet crossover cable may be needed when connecting the camera directly to the PC.

Ethernet Connector LEDs



- Green **Link** LED indicates good network connection.
- Orange **Activity** LED flashes for network activity indication.

NOTE! The ITE is to be connected only to PoE networks without routing to the outside plant or equivalent description.

Accessing the Camera

The 5MP Indoor Micro Dome Camera supports all current browsers without requiring any additional plug-ins or add-ons (e.g. for H.264/H.265/MJPEG support).

Camera Login

The default IP address of the camera is: 10.x.x.x. By default, the camera starts as DHCP client and automatically tries to get an IP address from a DHCP server.

1. Enter the camera's IP address in the URL bar of the web browser and hit "Enter".
2. Enter the default username (**admin**) and password (**meinsm**).

NOTE! User names and passwords are case sensitive.

3. You will be prompted to set a new admin user password.

NOTE! The password can have between 6 and 16 characters (at least one digit, no special characters allowed).

4. After setting a new password, you will be prompted to log in again. Remember to use the new password.

Browser-Based Viewer

The main page of the IP camera user interface is shown as the figure below. The function buttons vary depending on the camera model.

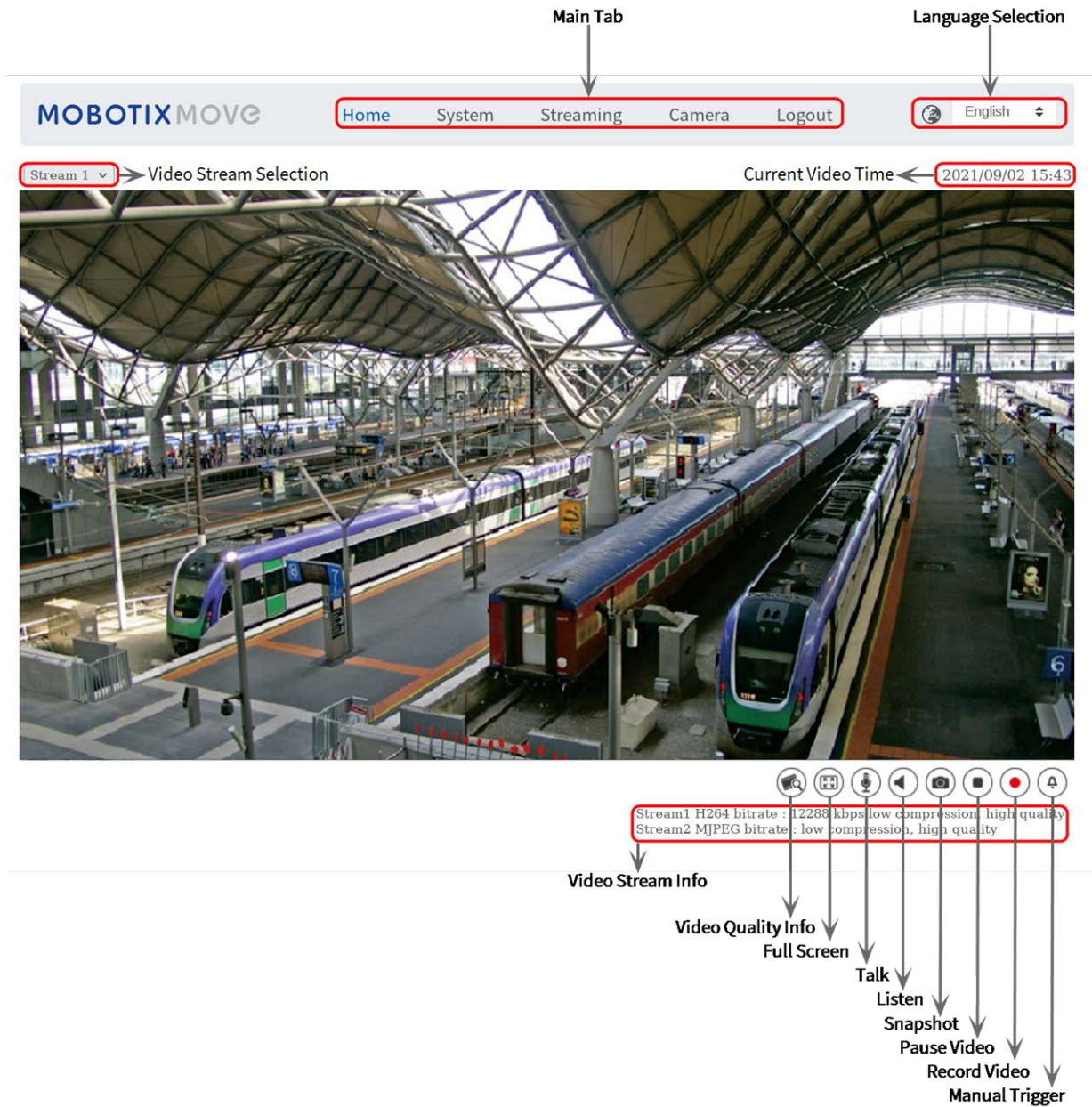

Formatting the SD Card

After inserting a new or replacing a used SD card, the card must be formatted before the camera can use it to record video streams.

1. Connect to the camera.
2. Open **System > Storage Management > SD Card**.
3. In the **Device Setting** section, click on **Format** to start the formatting process.

Once formatting has finished, the camera can use the SD card for recording.

Camera Maintenance

It is recommended that you perform the following maintenance tasks at regular intervals to keep the 5MP Indoor Micro Dome Camera in good working condition:

- Clean the dome using plain water and a soft cloth.

CAUTION! Do not use any detergents or alcohol to prevent damaging the coating!

- Check the mounting and make sure that all screws are properly tightened to prevent the camera from falling down.
- When opening the camera, add a silica gel dry pack to prevent condensation accumulating at the dome.

Further Reading

Manuals and Quick Installation documents



Technical Specifications



MOBOTIX MOVE Installation Hints



MOBOTIX

BeyondHumanVision

EN_01/23

MOBOTIX AG • Kaiserstrasse • D-67722 Langmeil • Tel.: +49 6302 9816-103 • sales@mobotix.com • www.mobotix.com

MOBOTIX is a trademark of MOBOTIX AG registered in the European Union, the U.S.A., and in other countries. Subject to change without notice. MOBOTIX do not assume any liability for technical or editorial errors or omissions contained herein. All rights reserved. © MOBOTIX AG 2020