



Technical Specifications

MOBOTIX MOVE 2MP Speed Dome Low Light Camera

The MOBOTIX MOVE 2MP Speed Dome Low Light Camera is equipped with the SONY Ultra Low-Light Sensor chipset supporting light sensitivities of down to 0.02 lux in color mode. The camera features Servo Feedback Technology. When encountering external force, such as vandalism or vibration, the PTZ can return immediately to its original position. The MOBOTIX EverClear superhydrophilic and self-cleaning nano coating of the dome ensures best image quality even in rain and reduces cleaning efforts and operational costs.

- EverClear coating of dome
- Servo Feedback – No Drifting
- WDR up to 130 dB
- Electronic Image Stabilizer (EIS)
- H.264/H.265/MJPEG Simultaneous Streaming
- High Low-Light performance, Color-Mode: 0.02 lux
- Dual power (PoE+/AC24 V)
- IP66 and Full IK10
- ONVIF Profile S/G/T Support
- Temp. Range –40 to 55 °C/-40 to 131 °F with heater
- 3D Motion Compensated Noise Reduction (MCTF)
- Smart Event Functions
- Text Overlay and Privacy Masks
- Smart Low Bitrate Control
- Triple Stream Support
- RS485 Support
- Up to 30x Optical Zoom
- Auto Object Tracking



Technical Specifications

MOBOTIX MOVE 2MP Speed Dome Low Light Camera

Remotely Upgradable Firmware

The firmware of the MOBOTIX MOVE 2MP Speed Dome Low Light Camera can be upgraded remotely. This applies to the IP system and the pan/tilt/zoom block. This feature instantly adds new features and greatly reduces maintenance costs.

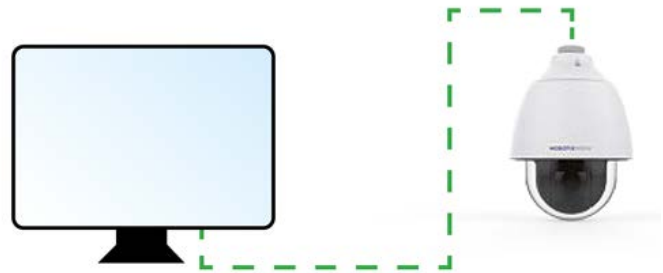

Servo Feedback

The MOBOTIX MOVE 2MP Speed Dome Low Light Camera features **Servo Feedback** technology. When encountering external force, such as vandalism or vibration, the PTZ immediately returns to its original position.



Product Information

Product Name	2MP Speed Dome Low Light Camera
Order Code	Mx-SD1A-230-LL

Image Quality

Image Sensor	2MP 1/2.8" Progressive CMOS
Effective (Used) Pixels	H x V = 1920x1080 (2MP)
Pixel Size	2.9 μm
Frame Rate (maximum)	WDR on/off: H.265/H.264: 2MP@30 fps MJPEG: 1080p@30fps
Dome Coating	Superhydrophilic MOBOTIX EverClear nano coating transforms water droplets into an ultra-thin water film upon impact. The coating ensures best image quality in rain and difficult external conditions and it reduces reflections and noise in low-light scenarios. EverClear is dirt-repellent and increases the stability as well as the scratch-resistance of the dome, further reducing maintenance efforts. Coating endurance up to 3 years depending on environmental conditions and cleaning treatment.

Lens

Minimum Illumination	Color: 0.02 lux B/W: 0.001 lux
Lens Characteristics	Motorized Lens: Zoom, Focus, P-IRIS, Auto-IRIS Focal Length: 4.3 to 129 mm Aperture: F1.6 – F4.7 Horizontal Field of View: 59° (Wide), 2.4° (Tele) Vertical Field of View: 35.2° (Wide), 1.4° (Tele)

Camera

Shutter Time	1 to 1/10000 s
Shutter Priority Mode	Up to 1/45 s
WDR	Up to 130 dB
Electronic Image Stabilizer (EIS)	Yes
Auto Object Tracking	On/off
Zoom	Optical: 30x, Digital: 10x
Image Settings	Color, Brightness, Sharpness, Contrast, White Balance, Exposure Control, 2DNR, 3DNR, NR by Motion, Masking, Text Overlay
Image Rotation	90°, 180°, 270°
Servo Feedback	Yes (see Servo Feedback, p. 2)

Video Codec

Compression/Encoding	H.265/H.264/MJPEG
Streaming	Up to 3 individually configurable streams in H.264/H.265/MJPEG. Configurable resolution, frame rate, bandwidth LBR/VBR/CBR in H.265/H.264.

Technical Specifications

MOBOTIX MOVE 2MP Speed Dome Low Light Camera

Cyber Security Features

Password Protection	Yes
IP address filtering	Yes
IEEE 802.1X network access control	Yes
Digest authentication	Yes
AES encryption for password protection	Yes
SNMP, TLS, HTTP, HTTPS	Yes
User and Group Management	Yes
SSL connections	Yes
VPN	Yes
Digital image signature	Yes
RSA encryption (2048 bits)	Yes

Network

Interface	10/100 Mbps Ethernet
Supported Protocols	ARP, PPPoE, IPv4/v6, ICMP, IGMP, QoS, TCP, UDP, DHCP, UPnP, SNMP, SMTP, RTP, RTSP, HTTP, HTTPS, FTP, NTP, DDNS, SMBv2
ONVIF conformance	Supports profiles S/G/T
Supported Browsers	All current browsers are supported.

System Integration

Base Video Analytics	Motion detection
Event Triggers	<ul style="list-style-type: none">External InputAnalyticsNetwork failure detectionPeriodical eventManual trigger

Event Actions	<ul style="list-style-type: none">▪ External output activation▪ Video recording to edge storage▪ File upload: FTP, network share and email▪ Notification: HTTP, FTP, email
---------------	---

General

Housing material	Metal and plastic
Power Requirements	PoE+ IEEE802.3at, class 4, max 23.11 W AC24V, max 24.20 W, max 39.60 VA
PoE Modes Supported	Mode A or Mode B
Connectors	<ul style="list-style-type: none">▪ RJ45▪ 4 x Alarm in, 2x Alarm out terminal block▪ AC 24 V terminal block▪ RS485 terminal block
Video Storage	Micro SD/SDHC/SDXC card support up to 1 TB, Support for recording to NAS, MOBOTIX MOVE NVR
Remotely Upgradable	Yes (see Remotely Upgradable Firmware, p. 2)
Environmental Protection Class	IP66/IK10
Operating Temperature	-40 to 55 °C/-40 to 131 °F with heater
Relative Humidity	10 to 90 % non-condensing
Storage Conditions	-20 to 70 °C/-4 to 158 °F
Approvals	EMC: CE/FCC, Safety: LVD, Environmental: IP66, IK10
Warranty	5 years
Dimensions	ø 210 x 279 mm
Weight	3100 g

Technical Specifications

MOBOTIX MOVE 2MP Speed Dome Low Light Camera

PTZ Features

Preset positions	Up to 256 positions, 1 Home position
Sequences	Up to 8 sequences with 64 preset positions each
Cruise Paths	Up to 8
Auto Pan Paths	Up to 4
Display Position	Pan/Tilt degrees can be displayed in live image
Tilt Angle	Between -20° and $+100^{\circ}$
Pan Angle	360° endless
Tilt Speed	Manual Tilt Speed: 0.1° – $60^{\circ}/s$ Preset Tilt Speed: 7° – $300^{\circ}/s$
Pan Speed	Preset up to $400^{\circ}/s$
Joystick/Keypoint Control	RS485 protocols DSCP, Pelco-D and Pelco-P

NOTE! Observe the [MOBOTIX MOVE Installation Hints](#) document to ensure optimum performance of the camera features.

Alarm Input/Output Current and Voltage

Alarm In	Alarm Out
5 V with 10 k Ω pull up, 50 mA	400 V DC/AC, 120 mA



DORI Specifications

In the video surveillance context, “DORI” stands for Detection, Observation, Recognition and Identification and is based on IEC EN62676-4: 2015. These levels define the minimum pixels that a face of a person must have to provide proper identification, for example.

- **Detection:** Up to this distance, you can reliably determine if a person or vehicle is present.
- **Observation:** Up to this distance, you can see characteristic details of an individual, such as distinctive clothing.
- **Recognition:** Up to this distance, you can determine with a high degree of certainty whether an individual is the same as someone that has been seen before.
- **Identification:** Up to this distance, you can determine the identity of an individual beyond reasonable doubt.





DORI Level	Detection		Observation		Recognition		Identification	
	Wide	Tele	Wide	Tele	Wide	Tele	Wide	Tele
Mx-SD1A-230-LL	70 m/ 230 ft	1768 m/ 5801 ft	28 m/ 92 ft	702 m/ 2303 ft	14 m/ 46 ft	354 m/ 1161 ft	7 m/ 23 ft	177 m/ 581 ft

Accessories

Picture	Order Code	Description
	Mx-A-SD-DBC-EC	Clear replacement dome with EverClear coating
	MX-A-SD-DBT-EC	Tinted replacement dome with EverClear coating
	Mx-M-SD-C	Corner Mount for MOBOTIX MOVE SpeedDome models (only in combination with SpeedDome Wall Mount Mx-M-SD-W/WM)
	Mx-M-SD-GN	Parapet Mount (Gooseneck) with integrated junction box for MOBOTIX MOVE SpeedDome models
	Mx-M-SD-P	Pole Mount for MOBOTIX MOVE SpeedDome models (only in combination with SpeedDome Wall Mount Mx-M-SD-W/WM)
	Mx-M-SD-PM	Pendant Mount Kit 25 cm for MOBOTIX MOVE SpeedDome models
	Mx-M-SD-PMEXT	Pendant mount extension 25 cm for use with Pendant Mount Kit Mx-M-SD-PM
	Mx-M-SD-W	Wall Mount for MOBOTIX MOVE SpeedDome models; can be combined with Pole Mount Mx-M-SD-P or Corner Mount Mx-M-SD-C

Technical Specifications

MOBOTIX MOVE 2MP Speed Dome Low Light Camera

Picture	Order Code	Description
	Mx-M-SD-WM	Wall Mount with room for optional junction box Mx-M-SD-WMJB for MOBOTIX MOVE SpeedDome models
	Mx-M-SD-WMJB	Wall Mount Junction Box for MOBOTIX MOVE SpeedDome models
	Mx-NPA-UPOE1A-60W	UPoE Network Power Injector 60 W
	Mx-A-ETP1A-2601-SET	Media Converter Set Ethernet (PoE+) – Twisted-Pair

Dimensions

NOTE! Download the drilling template from the section or on the MOBOTIX website: www.mobotix.com > Support > Download Center > Marketing & Documentation > Drilling Templates.

CAUTION! Always print or copy the drilling template at 100% of the original size!

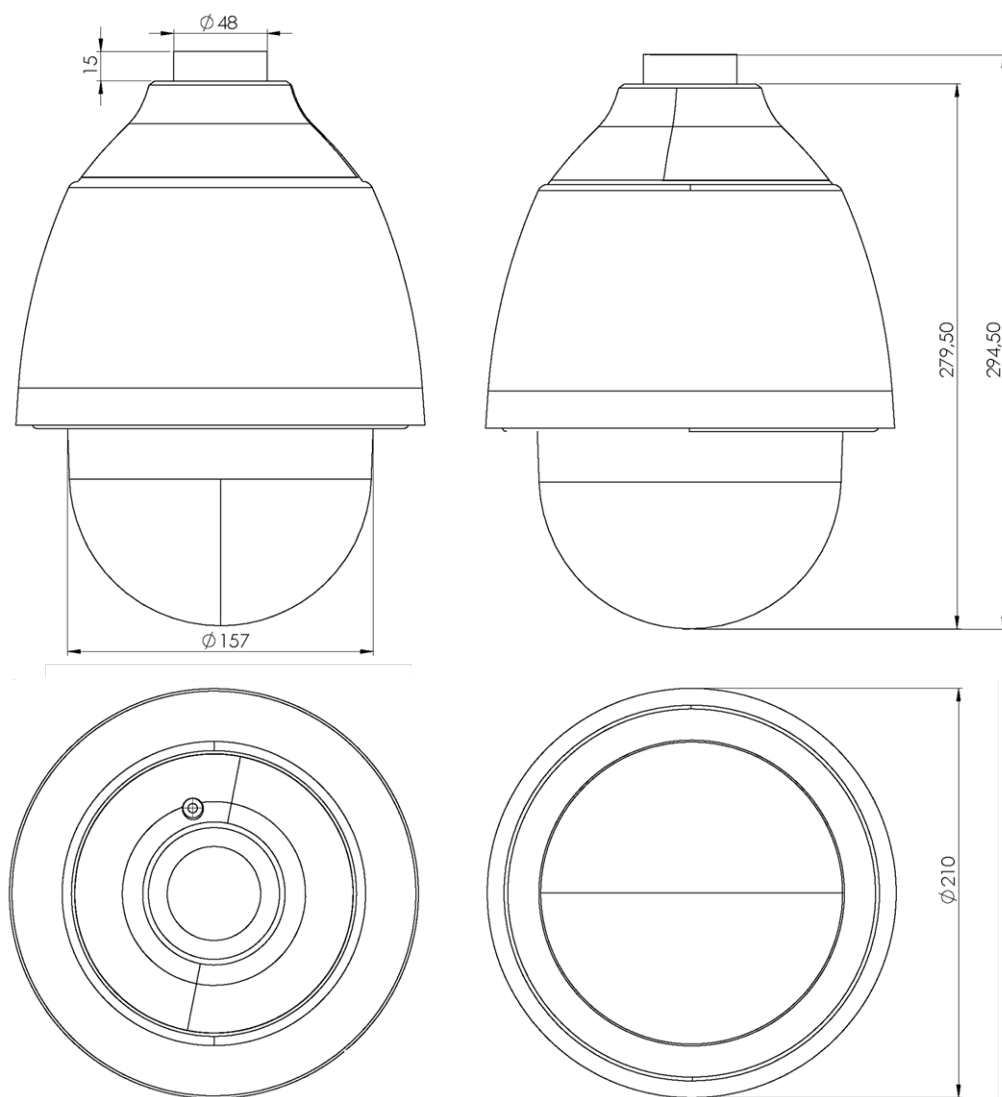

Fig. 1: 2MP Speed Dome Low Light Camera: All measurements in mm

Further Reading

Manuals and Quick Installation documents



Technical Specifications



MOBOTIX MOVE Installation Hints



MOBOTIX

BeyondHumanVision

EN_01/23

MOBOTIX AG • Kaiserstrasse • D-67722 Langmeil • Tel.: +49 6302 9816-103 • sales@mobotix.com • www.mobotix.com

MOBOTIX is a trademark of MOBOTIX AG registered in the European Union, the U.S.A., and in other countries. Subject to change without notice. MOBOTIX do not assume any liability for technical or editorial errors or omissions contained herein. All rights reserved. © MOBOTIX AG 2021