

Quick Installation

MOBOTIX 3MP Speed Dome Camera

Mx-SD1A-330

© 2023 MOBOTIX AG

NOTE!

This guide is only valid for **installing and connecting** the 3MP Speed Dome Camera. For more information on the camera, please refer to the other documents (see [Further Reading, p. 9](#)).

Important Installation Notes

- This product must not be used in locations exposed to the dangers of explosion.
- Do not use this product in a dusty environment.
- Protect this product from moisture or water entering the housing.
- Install this product as outlined in this document. A faulty installation can damage the product!
- Do not replace batteries of the camera. Risk of explosion may occur if the battery is replaced by an incorrect type.
- This equipment is not suitable for use in locations where children are likely to be present.
- External power supplies must comply with the Limited Power Source (LPS) requirements and share the same power specifications with the camera.
- When using a Class I adapter, the power cord shall be connected to a socket-outlet with proper ground connection.
- To comply with the requirements of EN 50130-4 regarding the power supply of alarm systems for 24/7 operation, it is highly recommended to use an uninterruptible power supply (UPS) for backing up the power supply of this product.
- This equipment is to be connected only to PoE networks without routing to other networks.

NOTE! Observe the [MOBOTIX MOVE Installation Hints](#) document to ensure optimum performance of the camera features.

NOTE! To ensure that the unit is not affected by vibration, twisting, etc. after adjusting the camera, properly tighten all mounting screws.

Camera Connectors

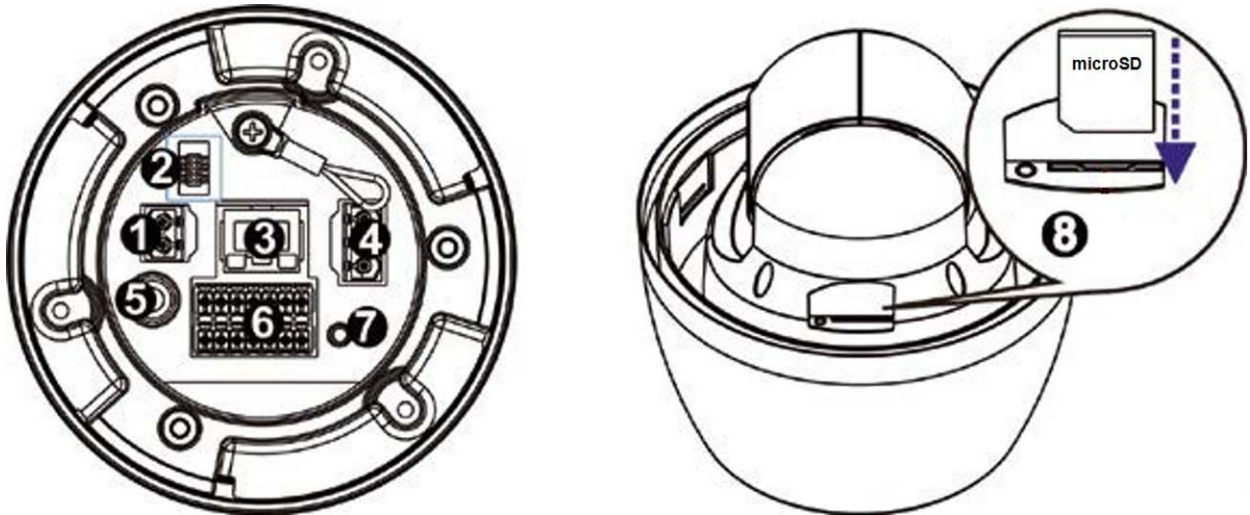

No.	Connector	Definition
1	Power Connector (DC12V)	DC12V power connection
2	Console Connector	This connector is used to burn firmware into the camera when the camera is returned for repair/maintenance. Please contact the camera manufacturer for further information.
3	RJ-45 Port	For network and PoE+ connections
4	Power Connector (AC24V)	AC24V power connection (see Connecting Power, p. 3 below)
5	BNC*	For analog video output (available only with max. 2 activated streams)
6	Audio/Alarm I/O & RS485 Connector**	Audio/Alarm I/O & RS485 connection (see Connect Audio and Alarm I/O below)
7	Reset Button	Press the button with a proper tool for at least 20 seconds to restore the system.
8	SD Card Slot	Insert the SD card into the card slot to store videos and snapshots. Do not remove the SD card when the camera is powered on.

*Contact the manufacturer for a compatible BNC cable.

**Do NOT connect an external power supply to the alarm I/O connector of the camera.

NOTE! To purchase a power adapter, please contact MOBOTIX for further information.

CAUTION! Never connect both DC12V power and AC24V power since this **will cause unforeseeable damage**.

microSD Card Slot/Default Button

CAUTION! Always power down the camera before performing the following steps!

microSD Card Slot

Insert the microSD card into the card slot to store videos and snapshots.

NOTE!

- It is not recommended to record with the microSD card for 24/7 continuously, as it may not be able to support long term continuous data read/write. Contact the manufacturer of the microSD card for information regarding the reliability and the life expectancy.
- Remember to format a new microSD card as shown in [Formatting the SD Card](#) below.

Default Button

Press the default button with a proper tool for at least 20 seconds to restore the system.

Connecting Power

Using Power over Ethernet (PoE)

Use a PoE+ switch (Class 4) and connect the Ethernet cable to the RJ-45 port of the camera.

Using AC24V or DC12V

To power up the camera, connect **either the DC12V or the AC24V** power adapter to the power connector of the camera and the power outlet.

CAUTION! Never connect both DC12V power and AC24V power since this **will cause unforeseeable damage**.

Diagram and Pin Definition for AC24V Power Connection

Pin	Definition
1	AC24V L
2	GND
3	AC24V N

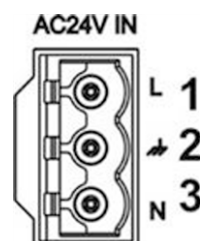

Zero Downtime Power Switching (ZDT)

If the camera is connected to two power sources, it will switch the power input seamlessly in this order:

- **AC and PoE connected:** AC > PoE
- **DC and PoE connected:** PoE > DC

CAUTION! Never connect both DC12V power and AC24V power since this **will cause unforeseeable damage.**

Ethernet Cable Connection

Connect one end of the Ethernet cable to the RJ-45 connector of the camera and plug the other end of the cable into the network switch or PC.

NOTE!

- The length of the Ethernet cable should not exceed 100 m/300 ft.
- Check the status of the link indicator and the activity indicator LEDs of the switch. If the LEDs are unlit, please check the LAN connection.
- In some cases, an Ethernet crossover cable may be needed when connecting the camera directly to the PC.

Ethernet Connector LEDs

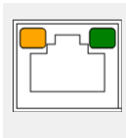

- Green **Link** LED indicates good network connection.
- Orange **Activity** LED flashes for network activity indication.

NOTE! The ITE is to be connected only to PoE networks without routing to the outside plant or equivalent description.

Audio/Alarm I/O & RS485 Connector

Please refer to the diagram and pin definition tables below for using the audio/alarm I/O & RS485 connection.

Pin	Definition
1	Audio Out
2	GND (Audio I/O)
3	Alarm Out A1
4	Alarm Out A2
5	Alarm Out B1

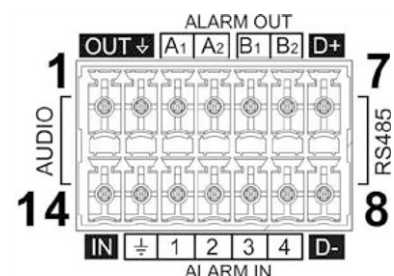

Pin	Definition
6	Alarm Out B2
7	RS485 D+
8	RS485 D-
9	Alarm In 4
10	Alarm In 3
11	Alarm In 2
12	Alarm In 1
13	GND (Alarm I/O and RS485)
14	Audio In

Camera Installation Notice

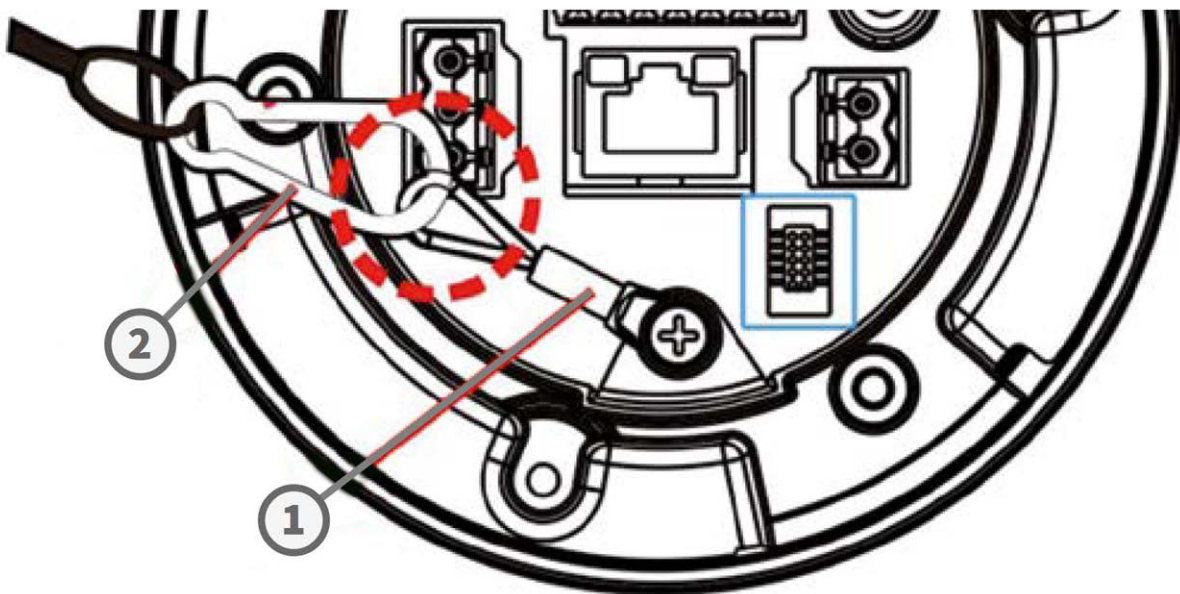

NOTE! For safety reasons, it is recommended to hook up the camera's anti-drop ring ① with the anti-drop chain ② of the pendant when installing the camera. For more information about the pendant and anti-drop chain, please see the corresponding Quick Installation document available at www.mobotix.com > **Support** > **Download Center** > **Marketing & Documentation** > **Manu-als** in the *Speed Dome Accessories* section..

Accessing the Camera

The 3MP Speed Dome Camera supports all current browsers without requiring any additional plugins or add-ons (e.g. for H.264/H.265/MJPEG support).

Camera Login

The default IP address of the camera is: 10.x.x.x. By default, the camera starts as DHCP client and automatically tries to get an IP address from a DHCP server.

1. Enter the camera's IP address in the URL bar of the web browser and hit "Enter".
2. Enter the default username (**admin**) and password (**meinsm**).

NOTE! User names and passwords are case sensitive.

3. You will be prompted to set a new admin user password.

NOTE! The password can have between 6 and 16 characters (at least one digit, no special characters allowed).

4. After setting a new password, you will be prompted to log in again. Remember to use the new password.

Browser-Based Viewer

The main page of the IP camera user interface is shown as the figure below. The function buttons vary depending on the camera model.

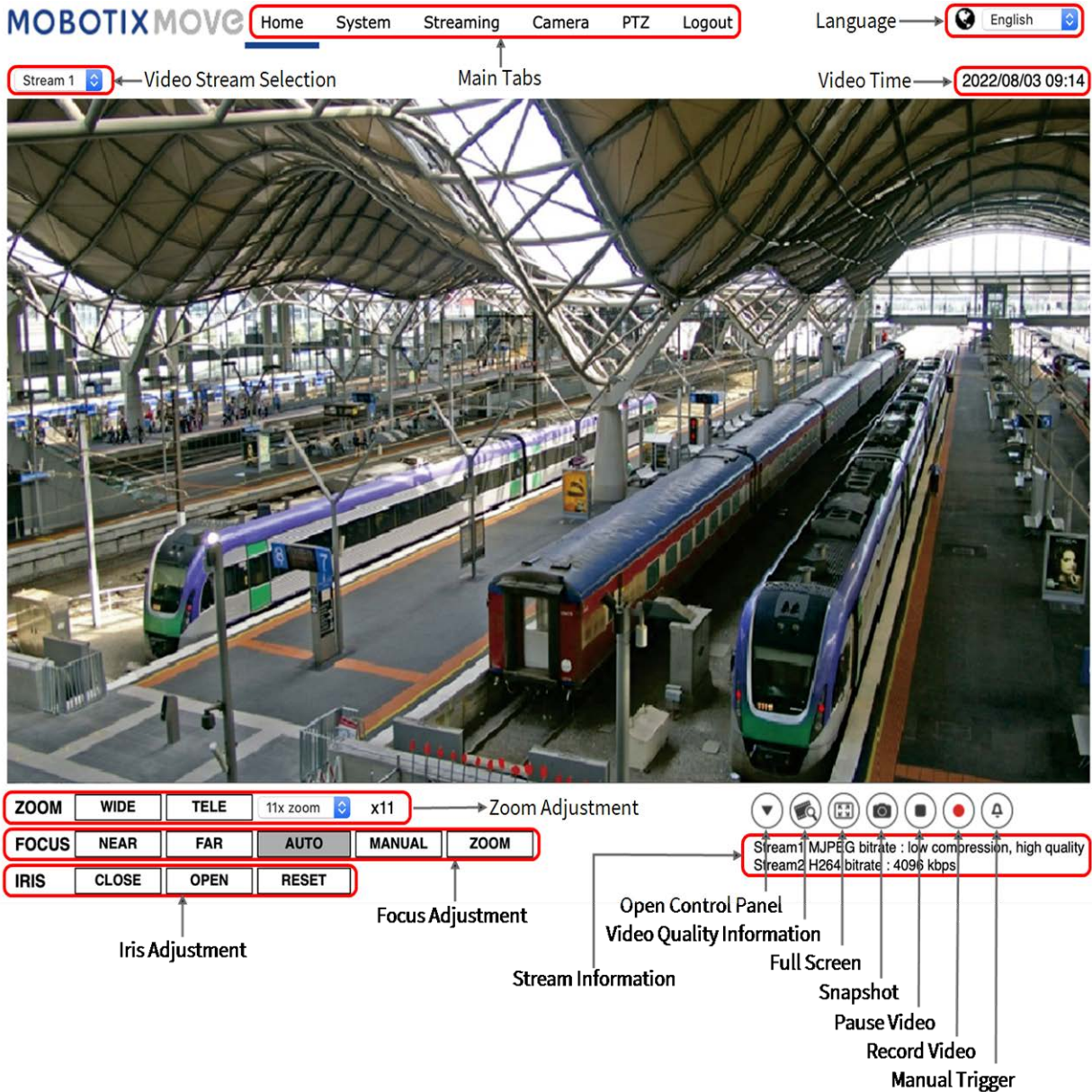

Formatting the SD Card

After inserting a new or replacing a used SD card, the card must be formatted before the camera can use it to record video streams.

1. Connect to the camera.
2. Open **System > Storage Management > SD Card**.
3. In the **Device Setting** section, click on **Format** to start the formatting process.

Once formatting has finished, the camera can use the SD card for recording.

Camera Maintenance

It is recommended that you perform the following maintenance tasks at regular intervals to keep the 3MP Speed Dome Camera in good working condition:

- Clean the dome using plain water and a soft cloth.

CAUTION! Do not use any detergents or alcohol to prevent damaging the coating!

- Check the mounting and make sure that all screws are properly tightened to prevent the camera from falling down.
- When opening the camera, add a silica gel dry pack to prevent condensation accumulating at the dome.

Further Reading

Manuals and Quick Installation documents



Technical Specifications



MOBOTIX MOVE Installation Hints



MOBOTIX

BeyondHumanVision

EN_02/23

MOBOTIX AG • Kaiserstrasse • D-67722 Langmeil • Tel.: +49 6302 9816-103 • sales@mobotix.com • www.mobotix.com

MOBOTIX is a trademark of MOBOTIX AG registered in the European Union, the U.S.A., and in other countries. Subject to change without notice. MOBOTIX do not assume any liability for technical or editorial errors or omissions contained herein. All rights reserved. © MOBOTIX AG 2018