

Quick Installation

MOBOTIX MOVE NVR-16

© 2023 MOBOTIX AG



HEVC Advance™



BeyondHumanVision

MOBOTIX

Table of Contents

Table of Contents	2
Before You Start	5
Support	6
Safety Notes	6
Legal Notes	7
Installation	9
Package Contents	9
Front Panel	10
Rear Panel	11
HDD Installation	14
List of Tested Hard Disks	16
Configuration	19
Power On the NVR	20
Login/Logout NVR System	20
Power Off the NVR	21
Function Tabs	21
Language and Date/Time Setup	21
Language Setup	21
Date/Time Setup	22
Network Setup	22
IP Camera Connection	22
Add Device	23
Check IP Camera Status	23
Playback/Export	24
Local Playback by Time	24
Local Playback By Event	24
Video Export By Time	25
Video Export By Event	25
Snapshot	25
Snapshot Export	26
Playback Control Icons	26
Video Export Function Icons	26
Snapshot Function Icons	26

Technical Specifications	27
Product Information	27
System	27
Recording/Playback	28
Storage & I/O	28
Onboard Hardware Interface	28
Network	29
General	29

Before You Start

This section contains the following information:

Support	6
Safety Notes	6
Legal Notes	7

Support

If you need technical support, please contact your MOBOTIX dealer. If your dealer cannot help you, he will contact the support channel to get an answer for you as quickly as possible.

If you have internet access, you can open the MOBOTIX help desk to find additional information and software updates. Please visit:

www.mobotix.com > [Support](#) > [Help Desk](#)



Safety Notes

- This product must not be used in locations exposed to the dangers of explosion.
- Do not use this product in a dusty environment.
- Protect this product from moisture or water entering the housing.
- Install this product as outlined in this document. A faulty installation can damage the product!
- This equipment is not suitable for use in locations where children are likely to be present.
- When using a Class I adapter, the power cord shall be connected to a socket-outlet with proper ground connection.
- To comply with the requirements of EN 50130-4 regarding the power supply of alarm systems for 24/7 operation, it is highly recommended to use an uninterruptible power supply (UPS) for backing up the power supply of this product.

Legal Notes

Legal Aspects of Video and Sound Recording

You must comply with all data protection regulations for video and sound monitoring when using MOBOTIX AG products. Depending on national laws and the installation location of the cameras, the recording of video and sound data may be subject to special documentation or it may be prohibited. All users of MOBOTIX products are therefore required to familiarize themselves with all applicable regulations and to comply with these laws. MOBOTIX AG is not liable for any illegal use of its products.

Declaration of Conformity

The products of MOBOTIX AG are certified according to the applicable regulations of the EC and other countries. You can find the declarations of conformity for the products of MOBOTIX AG on www.mobotix.com under **Support > Download Center > Marketing & Documentation > Certificates & Declarations of Conformity**.

RoHS Declaration

The products of MOBOTIX AG are in full compliance with European Unions Restrictions of the Use of Certain Hazardous Substances in Electrical and Electronic Equipment (RoHS Directive 2011/65/EC) as far as they are subject to these regulations (for the RoHS Declaration of MOBOTIX, please see www.mobotix.com, **Support > Download Center > Marketing & Documentation > Brochures & Guides > Certificates**).

Disposal

Electrical and electronic products contain many valuable materials. For this reason, we recommend that you dispose of MOBOTIX products at the end of their service life in accordance with all legal requirements and regulations (or deposit these products at a municipal collection center). MOBOTIX products must not be disposed of in household waste! If the product contains a battery, please dispose of the battery separately (the corresponding product manuals contain specific directions if the product contains a battery).

Disclaimer

MOBOTIX AG does not assume any responsibility for damages, which are the result of improper use or failure to comply to the manuals or the applicable rules and regulations. Our General Terms and Conditions apply. You can download the current version of the **General Terms and Conditions** from our website at www.mobotix.com by clicking on the corresponding link at the bottom of every page.

FCC Disclaimer

This equipment has been tested and found to comply with the limits for a Class A digital device, pursuant to part 15 of the FCC Rules. These limits are designed to provide reasonable protection against harmful interference when the equipment is operated in a commercial environment. This equipment generates, uses, and can radiate radio frequency energy and, if not installed and used in accordance with the instruction manual, may cause harmful interference to radio communications. Operation of this equipment in a residential area is likely to cause harmful interference in which case the user will be required to correct the interference at his own expense.

Installation

Package Contents

Make sure the delivered box contains the following items:

MOBOTIX MOVE NVR-16



Power Adapter



Power Cord

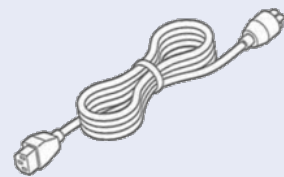

NOTE!

19" Rack Mounting Kit is not included, but can be obtained as optional accessory Mx-M-NVR16-RM for MOVE NVR-16 with serial number RD20600301 and higher.



Documentation

Scan the QR code or follow the link to find the MOBOTIX MOVE NVR-16 documentation:



www.mobotix.com > [Support](#) > [Download Center](#) > [Marketing & Documentation](#) > [Manuals](#) > [Accessories](#) > MOVE NVR-16.

Front Panel

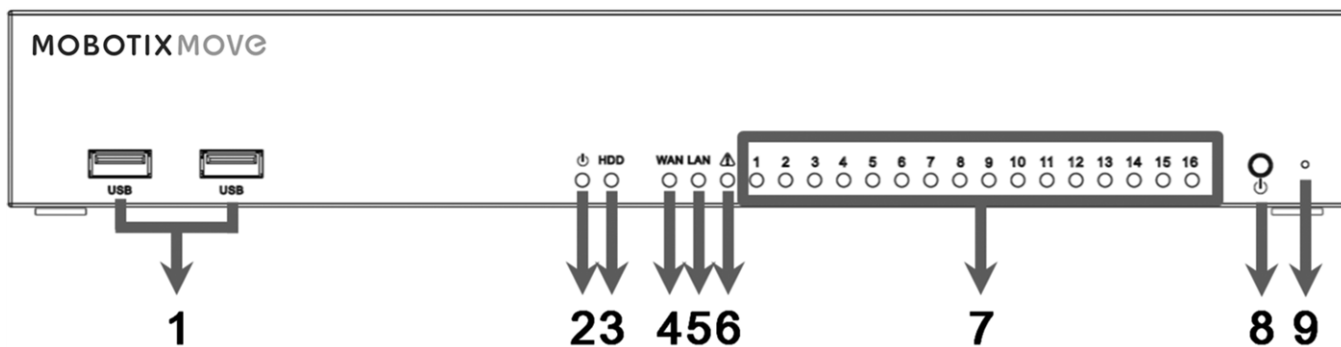

Item	Name	Description
1	USB 2.0 Port x2	USB ports allow users to connect external USB devices, such as a USB mouse, a USB keyboard, a USB storage device, etc.
2	Power LED	Lights up when the power is on.
3	HDD LED	<ul style="list-style-type: none"> ▪ Flashing: The HDD is reading/writing data. ▪ OFF: The HDD is not running.
4	WAN LED	<ul style="list-style-type: none"> ▪ Orange: Network speed is 1000Mbps. ▪ Green: Network speed is 10/100Mbps.
5	LAN LED	
6	P. Max	Lights up when there are 10 watts left to reach the power budget of PoE switch.
7	Camera LED	Lights up when the camera is powered up and has good network connection. <ul style="list-style-type: none"> ▪ Lights up in Green when the power source is from NVR.

Item	Name	Description
		<ul style="list-style-type: none"> Lights up in Orange when the camera is powered by external power supply.
8	Power Button	Press to power on the NVR system.
9	Reset Button	<p>To restore the factory defaults of the NVR system, use a proper tool for pressing the Reset button, then proceed as follows:</p> <ul style="list-style-type: none"> Power off the NVR system. Press and hold the Reset button. Power on the NVR system and keep the button pressed for another ten seconds.

Rear Panel

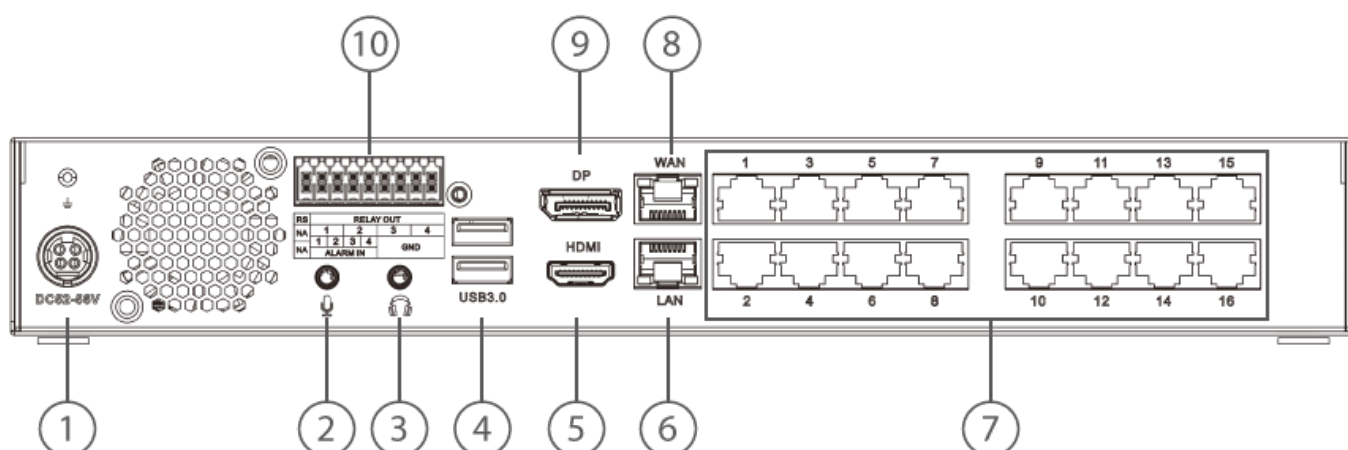

Item	Name	Description
1	Power Jack (DC 52 – 56 V)	Connect the power adapter and the power cord shipped with the NVR to power on the NVR system. Use other power supply may cause overloading.
2	Mic In	A 3.5 mm phone jack is provided to input/output audio.
3	Audio Out	
4	USB 3.0 Port x2	The USB ports allow users to connect external USB devices, such as a USB mouse, a USB keyboard, a USB storage device, etc.
5	HDMI Monitor	For connecting a monitor using its HDMI connector.
6	LAN (RJ-45)	The NVR is capable of connecting the Smart PoE Switch via LAN port.

Installation

Rear Panel

Item	Name	Description
	10/100/1000 Mbps	<ul style="list-style-type: none"> ▪ Green LED: Flashes when data is being transmitted via network. ▪ Orange LED: <ul style="list-style-type: none"> — Lights up in green when network speed is 10/100 Mbps. — Lights up in orange when network speed is 1000 Mbps.
7	PoE Switch	Provides network connectivity and power supply for up to 16 IP cameras.
8	WAN (RJ-45) 10/100/1000 Mbps	<p>This port is for connecting to the Internet (i.e., DSL router).</p> <ul style="list-style-type: none"> ▪ Green LED: Flashes when data is being transmitted via network. ▪ Orange LED: <ul style="list-style-type: none"> — Lights up in green when network speed is 10/100 Mbps. — Lights up in orange when network speed is 1000 Mbps
9	DisplayPort	For connecting a monitor using its DisplayPort connector.
10	Alarm I/O Connectors	For connecting other devices to the NVR (see pin definition below).

Alarm I/O Connectors

NOTE! These connectors are available on MOVE NVR-16 devices with a serial number of RD20C00201 and higher.

Pin Definition of Alarm I/O

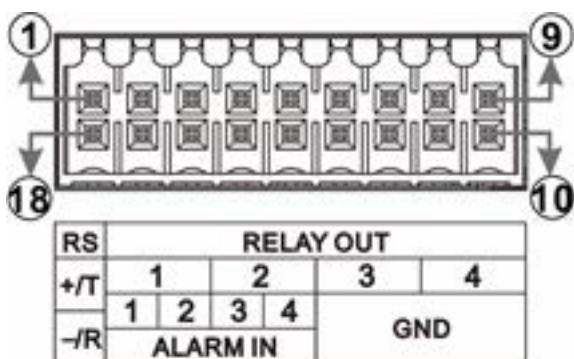

Pin	Definition	Pin	Definition	Pin	Definition	Pin	Definition
1	RS485+/T	6	Relay Out 3	10	GND 1	14	Alarm In 4
2	Relay Out 1	7		11	GND 2	15	Alarm In 3
3		8	Relay Out 4	12	GND 3	16	Alarm In 2

Pin	Definition	Pin	Definition	Pin	Definition	Pin	Definition
4	Relay Out 2	9		13	GND 4	17	Alarm In 1
5						18	RS485-/R

HDD Installation

CAUTION! Before you start:

- Make sure the device is powered off!
- Remove the power supply from the device!

Follow the steps below to install an HDD to the NVR:

1. Open top cover.
2. Remove HDD rack by unscrewing the four fixing screws.

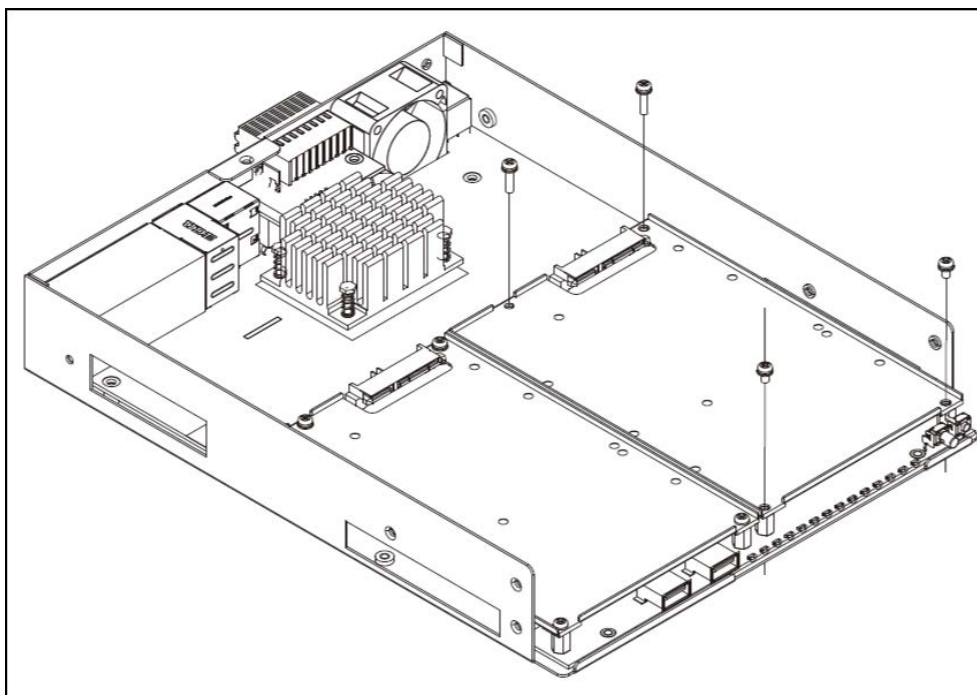

3. Fasten the HDD with the fixing screws delivered with the HDD as shown below.

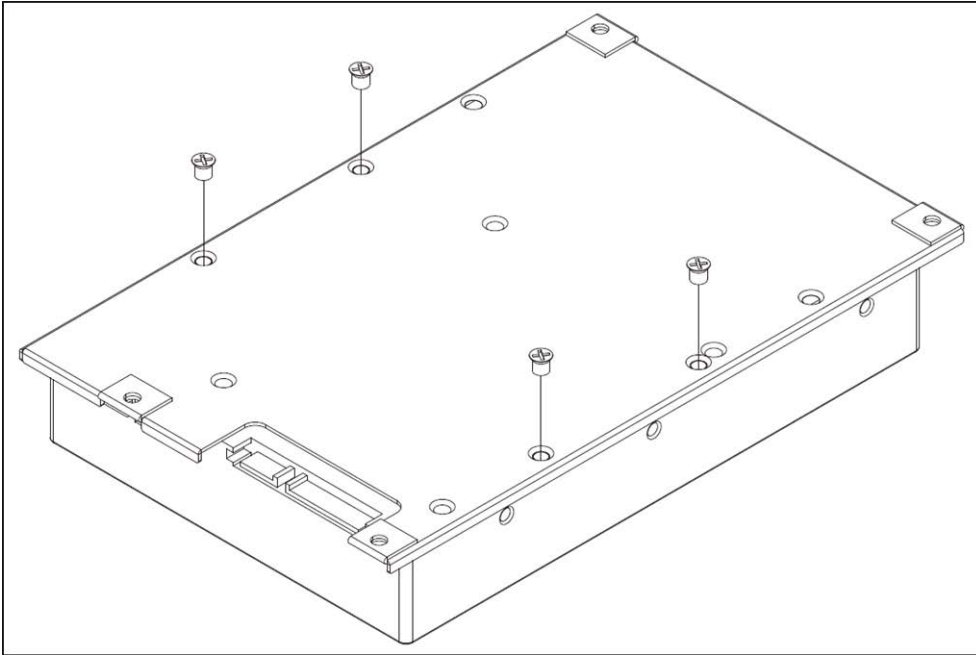

4. Mount the HDD rack back to its original position. No SATA cable required; the HDD is connected automatically.
5. Close top cover.

List of Tested Hard Disks

NOTE! To ensure long-term reliable operation, make sure that you are using **server-grade hard disks** from the manufacturers' series listed below.

Brand	Series	Model Number	Capacity
Seagate	Skyhawk	ST1000VX005	1 TB
		ST2000VX008	2 TB
		ST2000VX015	2 TB
		ST3000VX009	3 TB
		ST4000VX007	4 TB
		ST4000VX013	4 TB
		ST6000VX001	6 TB
		ST8000VX004	8TB
	SkyHawk AI	ST8000VE000	8 TB
		ST10000VE001	10 TB
		ST14000VE0008	14 TB
		ST16000VE000	16 TB
		ST18000VE002	18 TB
	Ironwolf	ST12000VN0008	12 TB
	Ironwolf Pro	ST16000NE000	16 TB

Brand	Series	Model Number	Capacity
Western Digital	Purple	WD10PURZ	1 TB
		WD20PURZ	2 TB
		WD30PURZ	3 TB
		WD40PURZ	4 TB
		WD60EJRX	6 TB
		WD60PURZ	6 TB
		WD62PURZ	6 TB
		WD82PURZ	8 TB
		WD84PURZ	8 TB
		WD102PURZ	10 TB
		WD121PURZ	12 TB
		WD140PURZ	14 TB
		WD180EJRX	18 TB
		WD180PURZ	18 TB
	Purple pro	WD8001PURP	8 TB
		WD141PURP	14 TB
	Gold (Ultrastar)	WD102KRYZ	10 TB
		WD121KRYZ	12 TB
		WD141KRYZ	14 TB
		WD161KRYZ	16 TB
		WD181KRYZ	18 TB
		WUH721818ALE6L4	18 TB

Configuration

NOTE!

Out of the box, the firmware of the MOVE NVR-16 supports its primary function as a Network Video Recorder.

By using an alternative firmware, the MOVE NVR-16 can be used as *Failover/Backup* server. Make sure to load this firmware on the target NVR **before setting up and configuring** the device. Open the MOBOTIX Download Center www.mobotix.com > **Support > Download Center > Software Downloads** and click on **MOVE NVR** to download the firmware.

If the MOVE NVR-16 is used as Failover/Backup server, it will no longer support the direct recording functionality.

For more information on the Failover/Backup server functionality, see the section ***NVR Failover Service*** in the *MOVE NVR-16 User Guide*.

Power On the NVR

1. **Before powering on the NVR, connect the necessary devices first:**

- USB Mouse & USB Keyboard
- Internet (WAN)
- Monitor (HDMI and/or DisplayPort)
- eSATA Storage Device (Optional)
- IP Cameras via PoE ports

2. Be sure to check the type of power source before plugging the power cord and power adapter into the NVR.

3. Press the Power Key on the front panel to power up the NVR system.

NOTE! If you want to use temporary USB storage media, make sure those devices are connected only **after** the NVR has been powered on.

Login/Logout NVR System

First Login

When logging in for the first time, you need to set the password for the Admin account. Make sure to store this password information in a safe place.

NOTE!

- Password length is 6 to 12 characters.
- These characters are allowed: A-Z, a-z, 0-9, !#\$%&'-.@^_~

At this point, you can also choose your preferred user interface language.

Login

Once the NVR is powered on, a popup window will appear:

- Click on OK to continue as user **Guest**.



NOTE! As guest user, you can only see live video. It is not possible to change any settings or to export data.

- Select a different user and enter the password.

Logout

To log out, click on the user name and select **LogOut**.

Power Off the NVR

1. Click Power icon  at the top-right corner of the monitor, and the Power Panel will show up.
2. Click Power Off icon , and the NVR system will start the shutdown procedure.
3. Otherwise, click Cancel icon  to abort.

NOTE! Do not remove the power source until the NVR is completely off.

Function Tabs

There are six function tabs including **Live View**, **Playback/Export**, **Add Device**, **Record**, **Setup** and **Log**.

- **Live View:** This function tab allows users to watch the live view of the connected IP devices and configure camera settings, such as PTZ control, image setup, video format, motion detection setup, etc.
- **Playback/Export:** You can playback/export the recorded videos filtered by time/event and review/-export the saved snapshots.
- **Add Device:** You can search and add the IP devices to the NVR via network and through PoE ports.
- **Record:** The Record function tab allows users to arrange recording schedule, configure circular recording, and setup alarm behavior configuration.
- **Setup:** Under Setup function tab, you can setup the basic NVR settings, such as language, factory default, date/time setup, network setup, storage setup, user account management, etc.
- **Log:** The NVR divides the log data into four categories, User Operation Log, IP Camera Event, VA Detected Event and PoE Switch Event. You can view, search and export the log data under this function tab.



Language and Date/Time Setup

Language Setup

1. Under **Setup** function tab, select **Language** to enter the language setting menu.
2. Select the preferred language from the language drop-down list and click **Apply** to save the setting.
3. Otherwise, click **Cancel** to cancel the setting.

Date/Time Setup

To edit the date/time settings, select **Setup > System > Date/Time**.

1. To set a date, select the correct date from the calendar and click **Apply** to save the setting.
2. To set up time, click on the target position in the time field (hour:minute:second AM/PM).
3. Click buttons  or  or scroll the mouse wheel up/down to adjust the time values.
4. Click **Apply** to save the setting.

Network Setup

Configure the network setup for the NVR to properly function with Ethernet connection. The Network setting menu can be found in this path: **Setup > Network**.

- **Interface:** You can setup WAN and LAN configuration under this setting menu. Select "WAN" to enter WAN configuration menu, and select "LAN" to setup the LAN settings.
- **DHCP Setup:** In the WAN configuration menu, the DHCP function allows users to obtain a dynamic IP address from DHCP (Dynamic Host Configuration Protocol) server when the NVR boots up.
- For DHCP users, check **Enable DHCP** box and click **Restart**. The IP address, Subnet Mask, Gateway and DNS settings listed in IPv4 will be retrieved from network servers. DHCP is dynamic that the settings change from time to time.
- For Non-DHCP users, uncheck **Enable DHCP** box, and fill out the required values listed in IPv4 by clicking on the box next to each item and using the displayed number pad or the USB keyboard. Please obtain the information from the network service provider.
- Click **Apply** to save the setting.

NOTE! For more details regarding LAN configuration, refer to User's Manual.

IP Camera Connection

You can connect the IP cameras to the NVR via the network connection or through the PoE ports on the rear panel.

Follow the instructions below to connect IP cameras to the NVR.

Add Device

NOTE!

- **By default, the cameras connected to the integrated PoE ports will get their IP addresses from the integrated DHCP server.** The default IP address range is 192.168.51.x, network mask is 255.255.255.0, with the first IP address set to **192.168.51.2**.
- To edit the IP address range assigned by the NVR and the IP address of a particular camera, open **Setup > PoE/IP Port Management > DHCP Server**.
- For more details regarding camera IP addresses and the DHCP setup for the PoE ports, refer to the **PoE Management Setup** section in the *User Manual*.

Adding a Camera

1. Activate the DHCP client of the camera (this is the default behavior on most cameras).
2. Attach the camera to a PoE port of the MOVE NVR-16 or to a PoE switch that is attached to a LAN port of the MOVE NVR.
3. Enter the **Add Device** function tab.
4. Select the preferred device type, e.g. MOBOTIX MOVE, Onvif, from the **Device Filter** drop-down list.
5. Click **Re-scan Device** icon  and the NVR will start to search and list the connected devices meeting the searching criteria.
6. Check **Device add to view** box in front of the desired IP device(s) to add it to the MOVE NVR.
7. To see the camera IP, open **Setup > PoE/IP Port Management > DHCP Server**.

Check IP Camera Status

In the Live View function tab, the camera title bar is above each channel grid. The IP camera connection status can be examined by the color of the title bar.

Title Bar Color	IP Camera Status
Grey	Not connected
Green	Connecting
Blue	In good connection
Red	Failed connection

Playback/Export

The NVR is capable of playing back the recorded videos by time/event and exporting the recorded videos and snapshots under Playback/Export function tab.

Follow the instructions below to operate the functions.

Local Playback by Time



1. Select any underlined date from the calendar, which indicates the recording data are available from these dates. The yellow stripe(s) in the time bar at the bottom of the function tab indicates available recorded videos for users to playback.
2. Then, click and drag the time bar below to assign a preferred time from the time bar. Move the mouse cursor to the time bar and scroll up/down the mouse wheel to adjust the time scale to select the exact desired time. The selected time will be displayed above the time bar.
3. Click Playback icon  to start playing back the recorded videos.

Local Playback By Event

1. In the Event Search Filter, check **Search By Time** box and specify the Start and End time of the desired time interval. Check **Search By Channel** box to select the desired channel. Check **Search By Type** box to select the preferred event type including Motion, Video Loss or Alarm.
2. Click **Search** and the event videos, which meet the searching criteria will be listed next to the Event Search Filter.
3. The Event List displays events by date/time, event type, and triggered camera channel in chronological order.
4. Click on any event; the NVR will automatically start playing back the selected event video.

Video Export By Time

Before starting the video export, make sure an external USB storage device is installed.



1. Click and drag the Time Interval icon  to the time bar to select the desired time interval of the recorded video.
2. Adjust the preferred time segment by dragging the Time Range Adjustment icon .
3. Click **Start Export**. An Export window will be displayed.
4. Check the desired channel(s) and the exportation data including data size will be shown.
5. Select the preferred video format.
6. Click **Confirm** in the Export window to start the video export.
7. Otherwise, click **Cancel** to abort.

Video Export By Event

Before starting the video export, make sure an external USB storage device is installed.

1. Choose the preferred event video from the Event List.
2. Click **Start Export**. An Export window will be displayed.
3. The exportation data including data size will be shown.
4. Select the preferred video format.
5. Click **Confirm** in the Export window to start the video export.
6. Otherwise, click **Cancel** to abort.

Snapshot









1. Click **Snapshot** setting menu and select the preferred snapshot from the Snapshot List to check its preview.
2. The information of the selected file, including the file created date/time, image resolution and image size, will be displayed next to the snapshot viewing window.
3. Check the preferred file(s) to be deleted and then click Delete icon  to remove the selected file(s) from the Snapshot List.
4. Otherwise, click Select All icon  to choose all the files at once.

Snapshot Export







Before starting the snapshot export, make sure an external USB storage device is installed.

1. Select the desired snapshot(s) from the Snapshot List.
2. Click Export icon , and an Export window will be displayed.
3. Click **Confirm** to start exporting the file(s); otherwise, click **Cancel** to abort.



Playback Control Icons

Icon	Description	Icon	Description	Icon	Description
	Forward Playback		Pause Playback		Backward Playback
	Playback Speed x 1/4		Playback Speed x 1/2		Playback Speed x 1
	Playback Speed x 2		Playback Speed x 4		

Video Export Function Icons

Icon	Description	Icon	Description
	Time Interval Pin		Time Range Adjustment
	Clear Tag		Start Export Video
	Data Erase/Protect		Instruction of Time Bar Adjustment

Snapshot Function Icons

Icon	Description	Icon	Description
	Delete Snapshot		Export Snapshot
	Select All Snapshots		

Technical Specifications

Product Information

Product Name	MOVE NVR-16
Order Code	Mx-S-NVR1A-16-POE

System

Operating System	Embedded Linux
CPU	Intel Apollo Lake J3455
RAM	4 x 1 GB, LPDDR4
Boot Drive	16 GB eMMC Flash
Graphics	Intel HD Graphics 500

Technical Specifications

Recording/Playback

DISPLAY PORT Output	1920x1080@60Hz (Full HD)
HDMI Output	1920x1080@60Hz (Full HD)
Audio Input	3.5 mm TRS phone jack
Audio Output	3.5 mm TRS phone jack
USB Ports	USB 2.0 x2 (front); USB 3.0 x2 (rear)

Recording/Playback

IPCAM Throughput	Average: 160 Mbps Peak: 240 Mbps
GPU Hardware Decoding	24 CH real-time display, up to 720 fps@D1 decoding
Compression Format	H.264/H.265

Storage & I/O

Digital Input	Input level 24V (H: $V_{in} \geq 2.4V$, L: $V_{in} \leq 1.6V$) 4 x Terminal Block
Digital Output	24V, 1A, Relay NC 4 x Terminal Block
Max. HDD storage support (internal & ext. iSCSI)	28 TB
Redundancy	Failover: N + M (include fallback) supported with alternative firmware

Onboard Hardware Interface

M.2 (M-Key)	Yes
-------------	-----

Network

WAN Uplink	RJ-45 x1, 10/100/1000 Mbps
LAN Uplink	RJ-45 x1, 10/100/1000 Mbps
LAN ports with PoE	RJ-45 x16, 10/100Mbps
PoE Level	IEEE 802.3 af/at x16
PoE & switch management	Linux SDK
Supported protocols	User Authentication, IEEE 802.1x, IPv4, TCP, UDP, DHCP, SMTP, RTP, RTSP, HTTP, NTP, DDNS, iSCSI

General

Unit Dimensions (mm)	280 x 300 x 44
Unit Weight (kg)	2.5
Package Dimensions (mm)	495 x 345 x 181
Package Weight (kg)	8.5
19" Rack Mounting Kit	Available as optional accessory Mx-M-NVR16-RM for devices with serial number RD20600301 or higher.
Operating Temperature	0 to 40 °C/32 to 104 °F
Operating Relative Humidity	10 to 90 % non-condensing
System Power Supply	AC 100 to 240 V, 200 W, 56 V/3.57 A
PoE Budget per Port	30 W
Total PoE Budget	140 W

MOBOTIX

BeyondHumanVision

[EN_03/23](#)

MOBOTIX AG • Kaiserstrasse • D-67722 Langmeil • Tel.: +49 6302 9816-103 • sales@mobotix.com • www.mobotix.com

MOBOTIX is a trademark of MOBOTIX AG registered in the European Union, the U.S.A., and in other countries. Subject to change without notice. MOBOTIX do not assume any liability for technical or editorial errors or omissions contained herein. All rights reserved. © MOBOTIX AG 2018