

Quick Installation

MOBOTIX MOVE 5MP IR Vandal Turret

Mx-VT1A-5-IR

© 2024 MOBOTIX AG

NOTE!

This guide is only valid for **installing and connecting** the 5MP IR Vandal Turret. For more information on the camera, please refer to the other documents (see [Further Reading, p. 9](#)).

Important Installation Notes

- This camera must be installed by qualified personnel and the installation should conform to all local codes.
- This product must not be used in locations exposed to the dangers of explosion.
- Do not use this product in a dusty environment.
- Protect this product from moisture or water entering the housing.
- Install this product as outlined in this document. A faulty installation can damage the product!
- Do not replace batteries of the camera. If a battery is replaced by an incorrect type, the battery can explode.
- This equipment is not suitable for use in locations where children are likely to be present.
- External power supplies must comply with the Limited Power Source (LPS) requirements and share the same power specifications with the camera.
- When using a Class I adapter, the power cord shall be connected to a socket-outlet with proper ground connection.
- To comply with the requirements of EN 50130-4 regarding the power supply of alarm systems for 24/7 operation, it is highly recommended to use an uninterruptible power supply (UPS) for backing up the power supply of this product.

Quick Installation 5MP IR Vandal Turret

NOTE! To ensure that the unit is not affected by vibration, twisting, etc. after adjusting the camera, properly tighten all mounting screws.

Package Contents

Check the package for the items listed below.

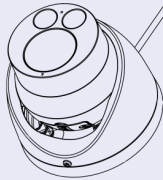

5MP IR Vandal Turret



3 x Plastic anchors



3 x self tapping screws



1 x Cable entry cover



1 x Water proof cover



1 x Security Torx Wrench (T 1 0) * 1



1 x Drilling template

Disassembling the Camera

1. Loosen the screw ① on the top cover using the T10 Torx wrench.
2. Remove the top cover ② .
3. Carefully remove the camera lens module ③ from the bottom camera case ④ .

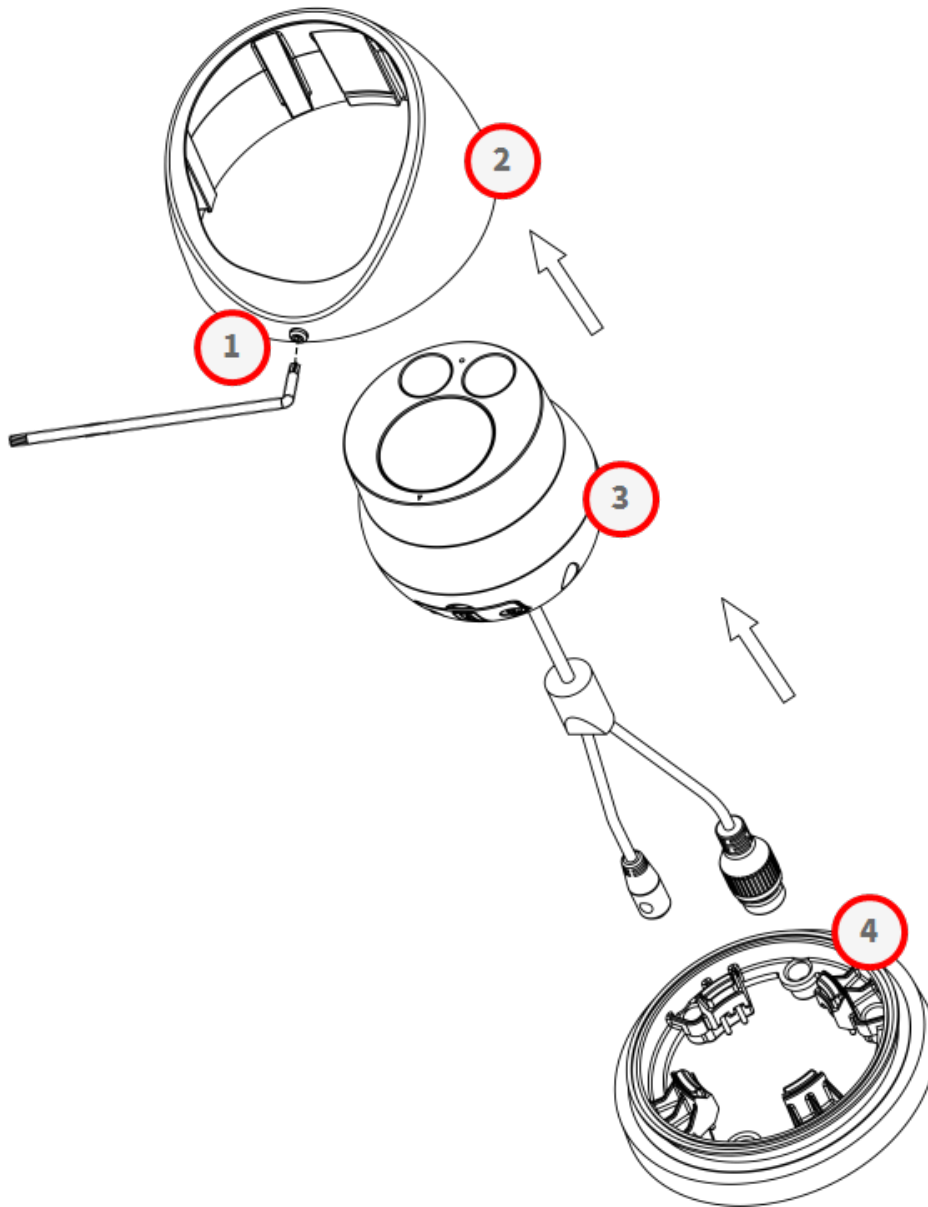

Inserting the SD Card

CAUTION! Always power down the camera before performing the following steps!

1. Remove the SD card cover ① from the camera lens module by loosening the screws ① with the T10 Torx wrench.
2. Insert the SD card into the corresponding slot.
3. Reattach the SD card cover.

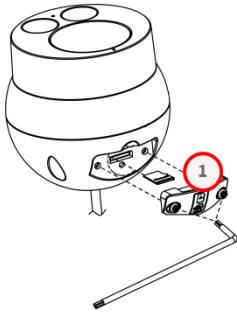

NOTE!

- It is not recommended to record with the microSD card for 24/7 continuously, as it may not be able to support long term continuous data read/write. Contact the manufacturer of the microSD card for information regarding the reliability and the life expectancy.

Mounting the Camera

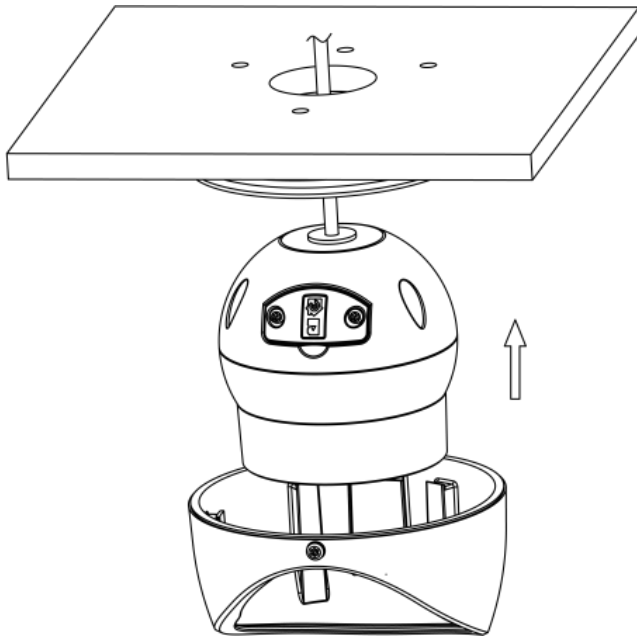

Mounting the camera routing the ethernet cable through the Surface

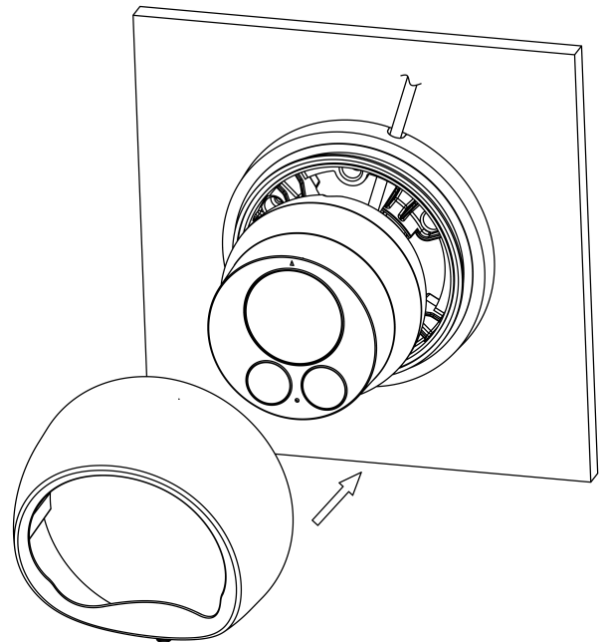

Mounting the camera routing the ethernet cable on the surface

1. Attach the drilling template to the wall or ceiling.

NOTE! You can choose to drill two or three holes on the mounting template. The following instructions are based on three holes.

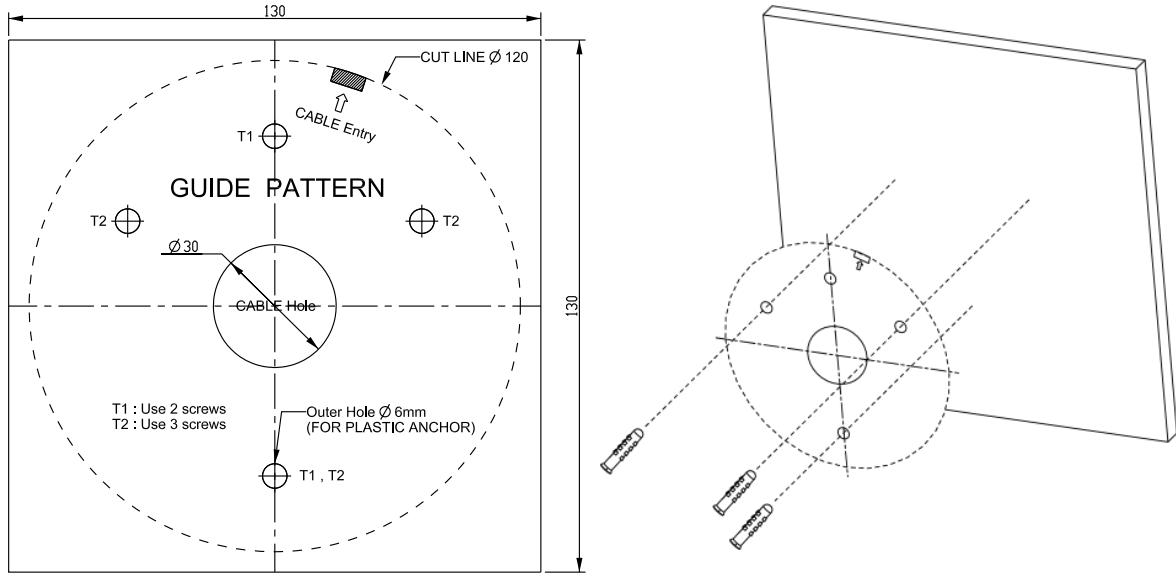

2. Drill the three holes according to the drilling template and insert the plastic dowels supplied.
3. If applicable, drill a hole for the cable gland.
4. Only when routing the ethernet cable through the surface attach the cable entry cover.
5. Use the self-tapping screws ① to attach the camera bottom case to the mounting surface ② prepared with the wall plugs.

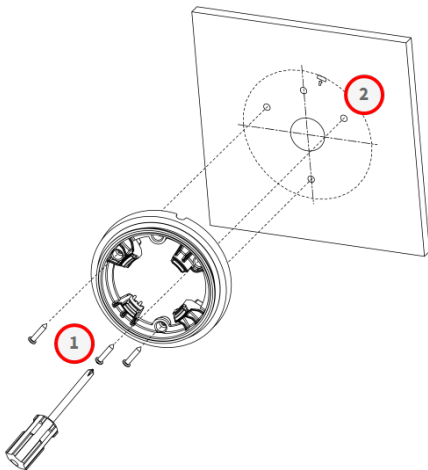

Quick Installation 5MP IR Vandal Turret

6. Attach the waterproof cover ③ to the ethernet cable.

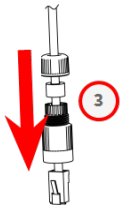

7. Connect the ethernet cable with the RJ-45 port of the camera and firmly close the waterproof cover.

NOTE!

- The length of the Ethernet cable should not exceed 100 m/300 ft.
- In some cases, an Ethernet crossover cable may be needed when connecting the camera directly to the PC.

8. Align the groove on the top cover ④ with the rim on the camera bottom case and attach the camera lens module and top cover to the camera bottom case.

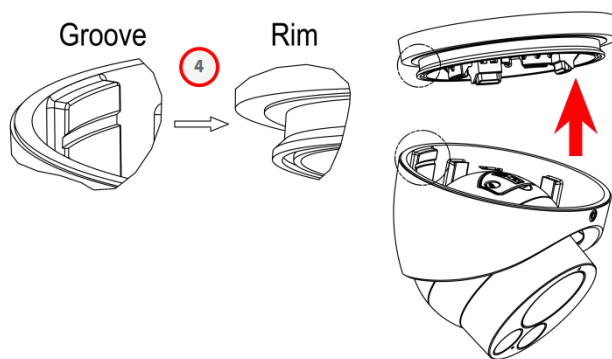

NOTE! Make sure the triangle arrow ⑤ is facing upwards

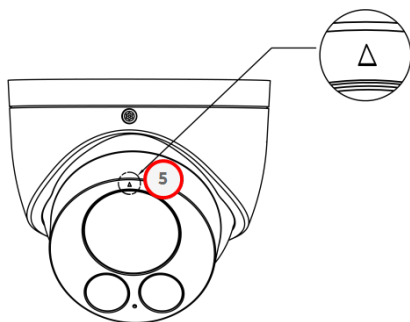

9. Adjust the camera lens module to the desired field of view.

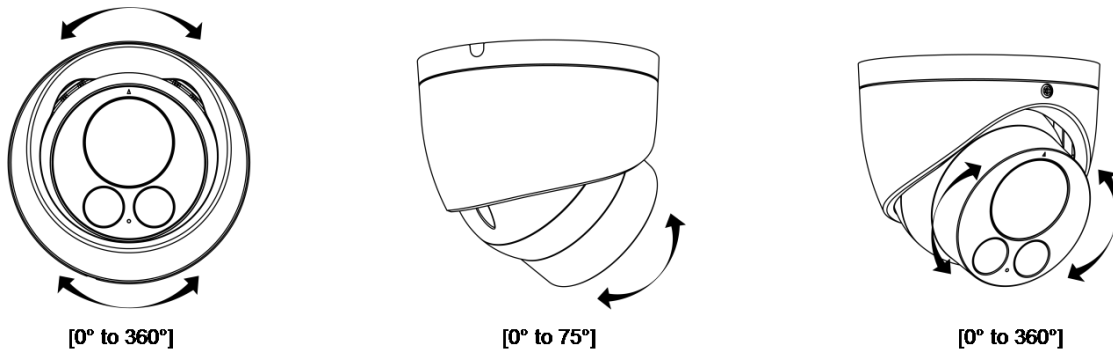

10. Close the housing screw ⑥ with the T10 Torx key to securely fasten the top cover to the lower camera housing.

Client System Requirements

System Hardware

CPU	i5-2430M CPU@ 2.40GHZ
RAM	6 GB or above
Display	NVIDIA GeForce 6 Series or ATI Mobility Radeon 9500
Power Supply	PoE (IEEE 802.3af Class 3)
Network	10/100BASE-T Ethernet (RJ-45 connector)

System Software

Operating System	Microsoft Windows 10 or above, MacOS Sierra or above
Browser	Mozilla Firefox, Google Chrome, Apple Safari, Microsoft Edge

Accessing the Camera

NOTE!

This MOBOTIX MOVE camera is designed for full integration with MOBOTIX and third-party software and recording solutions using common ONVIF S/G/T&M profiles.

When integrating this camera into MOBOTIX environments (e.g. MOVE NVR, MOVE CMS, MOBOTIX HUB MxMC, MOBOTIX CLOUD etc.) or third-party software, please use the ONVIF device search and integration method only.

The IP address of the camera can be found on the label on the camera housing.

Quick Installation 5MP IR Vandal Turret

1. Access the IP address of the camera with a web browser.
2. If you are accessing the camera's web interface for the first time, you must change the administrator password for user "ADMIN".

This Camera is Not Secure

Please setup the password for this device.

User Name:

Password:

Re-type Password:

NOTE!

The password must include at least

- 8 characters including
- 1 uppercase letter
- 1 special character

Further information about using the camera can be found in the "User Manual."

Further Reading

[Manuals and Quick Installation documents](#)



[Technical Specifications](#)



[MOBOTIX MOVE Installation Hints](#)



[MOBOTIX Community](#)



MOBOTIX

BeyondHumanVision

EN_04/24

MOBOTIX AG • Kaiserstrasse • D-67722 Langmeil • Tel.: +49 6302 9816-103 • sales@mobotix.com • www.mobotix.com

MOBOTIX is a trademark of MOBOTIX AG registered in the European Union, the U.S.A., and in other countries. Subject to change without notice. MOBOTIX do not assume any liability for technical or editorial errors or omissions contained herein. All rights reserved. © MOBOTIX AG 2021