



# Technical Specifications

## MOBOTIX MOVE 5MP Varifocal IR Vandal Turret

The MOBOTIX MOVE 5MP Varifocal IR Vandal Turret is designed to bring clarity and vigilance to your surveillance needs. This state-of-the-art turret camera combines advanced features with a compact and sleek design, making it an ideal choice for various indoor and outdoor applications. The Vari-Focal Turret Camera allows you to easily remote adjust the field of view and focus by a motorized lens, ensuring optimal positioning and alignment to meet the specific requirements of your surveillance scenario. The camera's weather-resistant design IP67 and IK10 ensures reliable operation even in challenging environmental conditions. Its compact turret form factor, combined with easy installation options, makes it a hassle-free choice.

- High Low-Light sensitivity
- 1/2.8" Progressive CMOS
- Motorized Vari-Focal Lens 2.7mm to 13.5mm
- WDR up to 120 dB
- Integrated adaptive IR Illumination working distance up to 30m.
- Triple Streaming H.264/H.265/MJPEG
- 2D & 3D Motion Compensated Noise Reduction (MCTF)
- ONVIF Profile S/G/T/M support
- Micro SD Card supports up to 512 GB.
- Integrated Microphone
- NDAA compliant
- Dual power Supply IEEE802.3af Class 3 / DC 12 V
- Temp. Range -30°C to 60°C/-22°F to 140 °F with heater
- Protection Rate IP67 / IK10
- Intelligent Encoding, Smart Low Bitrate Control is same as Smart compression offering optimally useable bandwidth and storage.



BeyondHumanVision

MOBOTIX MOVE

## Technical Specifications

### MOBOTIX MOVE 5MP Varifocal IR Vandal Turret

---

## Product Information

Product Name	5MP Varifocal IR Vandal Turret
Order Code	Mx-VT1A-503-IR

---

## Hardware Design

Processor	Novatec NT98560 (ARM Cortex-A9, single core, 960 MHz)
Memory	RAM: 512 MBytes FLASH: 256 MBytes
Image Sensor	5MP, 1/2.8" Progressive CMOS
Effective (Used) Pixels	2688x1944 (5MP)

---

## Lens

Minimum Illumination	Color: 0.18 lux B/W: 0.09 lux, (0 lux, IR on) F1.6, AGC=on, 30 IRE, 1/1 s
Lens Characteristics	Vari-Focal Lens Focal Length: 2.7mm to 13.5mm Aperture: F1.4-2.8 H x V FOV: 103°-31°(H) 76°-23°(V)

---

## Camera

Day/Night	Automatically switchable IR-cut filter
Shutter Speed	Auto / Manual / WDR: 1 to 1/10000 s
Shutter Priority Mode	Up to 1/7.5 s
Frame Rate (maximum)	<b>WDR on/off:</b> H.265/H.264: 5MP@30 fps MJPEG: 1080p@30 fps
Auto Gain	Min. gain: 0 dB, max. gain: 36 dB, step size: 3
WDR	Up to 120 dB

---

Zoom	Motorized optical: 2.67x
Image Settings	Color, Brightness, Sharpness, Contrast, White Balance, Gain Control, 2DNR, 3DNR, BLC, EV, Gamma corection, Saturation, Hue
Image Rotation	90°, 180°, 270°
Camera Body Adjust	Pan/Tilt/Rotation

---

## Video Codec

Compression/Encoding	H.265/H.264/MJPEG
Streaming	Up to 3 individually configurable streams in H.264/H.265/MJPEG. Configurable resolution, frame rate, bandwidth CVBR/CBR/istream in H.265/H.264

---

## Audio Codec

Compression/Encoding	G.711a/u
Streaming	One-way
Audio Input	Integrated Microphone

---

## Network

Interface	10/100 Mbps Ethernet
Supported Protocols	ARP, DHCP, DNS, FTP, HTTP, HTTPS, ICMP, IGMP, IPv4/6, NTP, RTSP/RTCP/RTP, RTMP, QoS, SMTP, SNMP v1/2c/3, TCP, TLS/TTLS, UDP, UPnP, 802.1X, Bonjour, DDNS, PPPoE
ONVIF conformance	Supports profiles S/G/T/M
Supported Browsers	Microsoft Edge, Firefox, Google Chrome

---

## Technical Specifications

### MOBOTIX MOVE 5MP Varifocal IR Vandal Turret

---

## System Integration

### Event Actions

- Schedule Recording (JPG/MP4)
- Video Analytics (Line Counting, Border Line)
- Video and audio recording to edge storage
- File upload: FTP and email
- Notification: Email (JPG)
- OSD indication
- SD Card recording (\*JPG/MP4)

## General

### Housing material

Metal

### IR Illumination

Adaptive IR - up to 30 m distance depending on scenery reflection

### Video Storage

Micro SD card support up to 512 GB.  
Support for recording to MOVE NVR, MOBOTIX Cloud (via MOBOTIX Bridge), MOBOTIX HUB, MxMC (via MOBOTIX NAS)

### Remotely Upgradable

Yes

### Power Requirements

IEEE802.3af, class 3, max 10 watt  
DC12V, max 10 watt

### Connectors

- RJ45
- 1 x DC 12V Jack Socket
- 1 x Reset / Default Button

### Environmental Protection Class

IP67/IK10

### Operating Temperature

-30°C to 60°C/-22°F to 140 °F with heater

### Relative Humidity

95 % non-condensing

### Storage Conditions

-40 to 60 °C/-4 to 158 °F

### Approvals

EMC: CE/FCC  
Safety: LVD

## Technical Specifications

### MOBOTIX MOVE 5MP Varifocal IR Vandal Turret

---

Warranty	5 years; mechanically wearable parts (motor, gears, belts, etc.) excluded
Dimensions	ø 120 x 104 mm (overall)
Weight	715 g

---

**NOTE!** Observe the [MOBOTIX MOVE Installation Hints](#) document to ensure optimum performance of the camera features.









# DORI Specifications

In the video surveillance context, “DORI” stands for Detection, Observation, Recognition and Identification and is based on IEC EN62676-4: 2015. These levels define the minimum pixels that a face of a person must have to provide proper identification, for example.

- **Detection:** Up to this distance, you can reliably determine if a person or vehicle is present.
- **Observation:** Up to this distance, you can see characteristic details of an individual, such as distinctive clothing.
- **Recognition:** Up to this distance, you can determine with a high degree of certainty whether an individual is the same as someone that has been seen before.
- **Identification:** Up to this distance, you can determine the identity of an individual beyond reasonable doubt.

DORI Level Order Code	Focal Length	Detection	Observation	Recognition	Identification
Mx-VT1A-503-IR	2.7 mm (Wide)	23 m/ 75.66 ft	12 m/ 39.47 ft	9.8 m/ 32.24 ft	4 m/ 13.16 ft
	13.5 mm (Tele)	52 m/ 171.05 ft	31.6 m/ 103.95 ft	25.8 m/ 84.87 ft	10.9 m/ 35.86 ft





## Accessories

Picture	Order Code	Description
	Mx-M-VT-WM	Wall Mount for MOBOTIX MOVE Vandal Turret Cameras
	Mx-M-VT-JB	Junction Box for MOBOTIX MOVE Vandal Turret Cameras
	Mx-M-VT-AP	Adapter Mounting-Plate for MOBOTIX MOVE Vandal Turret Cameras (mechanically adapts to Mx-M-SD-xx mounting Accessories)
	Mx-M-SD-C	Corner Mount
	Mx-M-SD-GN	Parapet Mount (Gooseneck) with integrated junction box
	Mx-M-SD-P	Pole Mount
	Mx-M-SD-PM	Pendant Mount Kit 25 cm
	Mx-M-SD-PMEXT	Pendant mount extension 25 cm for use with Pendant Mount Kit Mx-M-SD-PM

## Technical Specifications

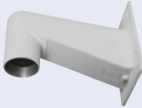
### MOBOTIX MOVE 5MP Varifocal IR Vandal Turret

---

Picture	Order Code	Description
	Mx-M-SD-W	Wall Mount; can be combined with Pole Mount Mx-M-SD-P or Corner Mount Mx-M-SD-C
	Mx-M-SD-WM	Wall Mount with room for optional junction box
	Mx-M-SD-WMJB	Wall Mount Junction Box
	Mx-A-ETP1A-2601-SET	Media Converter Set Ethernet (PoE+) – Twisted-Pair

---



## Dimensions

**NOTE!** Download the drilling template from the section or on the MOBOTIX website: [www.mobotix.com](http://www.mobotix.com) > [Support](#) > [Download Center](#) > [Marketing & Documentation](#) > [Drilling Templates](#).

**CAUTION!** Always print or copy the drilling template at 100% of the original size!

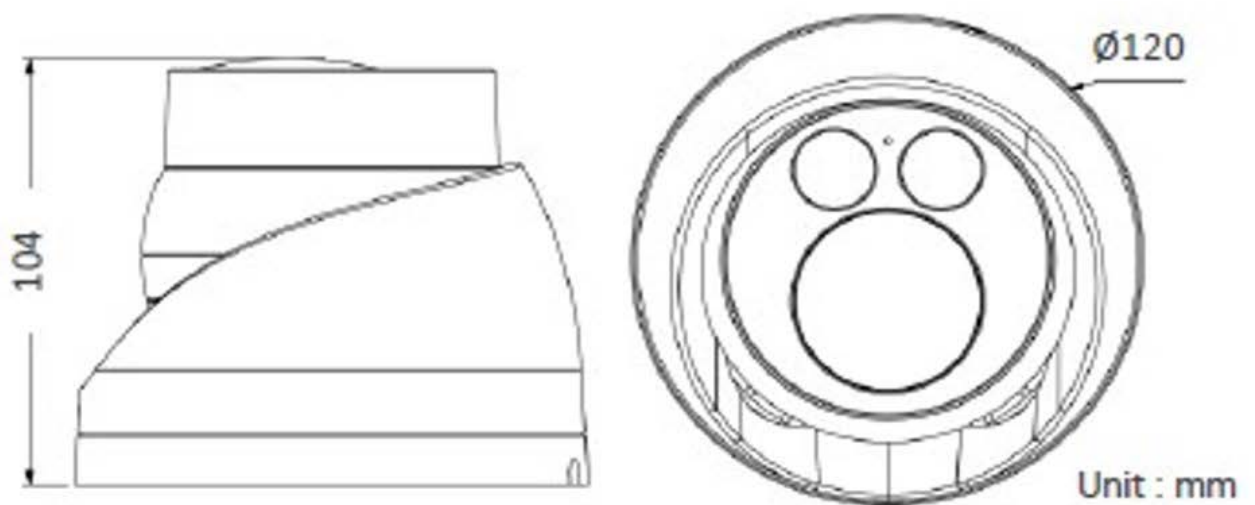

Fig. 1: 5MP Varifocal IR Vandal Turret: All measurements in mm

## Further Reading

[Manuals and Quick Installation documents](#)



[Technical Specifications](#)



[MOBOTIX MOVE Installation Hints](#)



[MOBOTIX Community](#)



# MOBOTIX

BeyondHumanVision

[EN\\_05/24](#)

MOBOTIX AG • Kaiserstrasse • D-67722 Langmeil • Tel.: +49 6302 9816-103 • [sales@mobotix.com](mailto:sales@mobotix.com) • [www.mobotix.com](http://www.mobotix.com)

MOBOTIX is a trademark of MOBOTIX AG registered in the European Union, the U.S.A., and in other countries. Subject to change without notice. MOBOTIX do not assume any liability for technical or editorial errors or omissions contained herein. All rights reserved. © MOBOTIX AG 2020