



Guideline

MOBOTIX M73 EN54 Bundle-V2

© 2026 MOBOTIX AG



BeyondHumanVision

MOBOTIX

Table of Contents

Table of Contents	2
Before You Start	5
Support	6
MOBOTIX Support	6
MOBOTIX eCampus	6
MOBOTIX Community	6
Safety Notes	7
Mitigation of Environmental Influences on EN 54 Thermal Fire Detection	7
Legal Notes	8
Intended Use	10
Introduction	11
Purpose of the Guideline	12
Target Audience	12
Scope and Limitations	12
EN 54 Fundamentals	13
Thermal Fire Detection vs. Conventional Fire Detection	13
Key Terminology	13
Thermal Calibration and Configuration	14
Scope of Delivery	15
M73 EN54 Bundle-V2: Scope of Delivery	16
Mx-M73A: Scope of Delivery	17
Connector Box RJ45: Scope of Delivery	18
Mounting Supplies: Scope of Delivery	19
Mx-4IOA-Box: Scope of Delivery	20
Mx-NPAA-Box: Scope of Delivery	21
Planning	23
Considerations Before Installing	24
Site Assessment – Indoor and Outdoor	24
Define Monitoring Objectives	24
Verify Detection Distance	24
Respect Maximum Cable Lengths	25
Indoor Environments	26
Outdoor Environments	26
EN 54-4-Compliant Power Supply/Power Consumption	26
Best Practices for Camera Positioning and Sensor/Lens Selection	27
Mounting Height and Angle Recommendations	28
Field-of-View Optimization	28
Sensor and Lens Selection	28
Installation	31
Wiring Overview	32
Installing the Components	33

Documentation for Components of M73 EN54 Bundle-V2	33
Notes on Installing Components	34
Initial Commissioning	35
Initial Camera Setup	36
Check the Preconditions	36
Access the Camera	36
Find the "Real" IP Address of the Camera	39
Thermal Calibration and Configuration	40
Adjusting the Configuring of the Camera to the Scene	45
Storing the Camera Configuration	47
Permanently Store the Configuration	47
Save the Configuration File	47
Verification and Functional Testing	48
Verification of Temperature Accuracy and Threshold Alarms	48
Practical Reference Sources	48
Acceptance Test Scenario Using a Blackbody Radiator	49
Verification Using MOBOTIX MxThermalValidation App	51
Handover to Customer	52
Documentation of Handover	53
Maintenance	55
Maintenance and Service	56
Documentation of Inspection and Maintenance	56
Cleaning the Camera and Lenses	56
Technical Specifications	59
Order Information	60
Hardware	60
Power Consumption	62
Image and Video Properties	62
General Software Features	63
Optional MOBOTIX Apps for EN 54 Fire Detection	64
Video Management Software	65
Sensor Modules	65
Features Thermal Image Sensors – B Models	65
Functional Modules	66
Interface Boxes	67
Mx-F-4IOA	67
Mx-F-NPAA	67
General Hardware Specifications	67
Connector Box RJ45	68
Dimensions	69
Dimensions of Interface Boxes	70
Appendix	71
Appendix A: Project Handover Documentation	72
1. General Project Information	72
2. Product Identification & EN 54 Compliance	72

Table of Contents

3. Site Risk & Application Suitability	73
4. Installation Documentation	73
5. System Integration & Alarm Paths	74
6. Commissioning Tests (EN 54-Compliant)	74
7. Configuration & Cyber/Access Controls	75
8. Customer Package	75
9. Acceptance	76
Appendix B: Project Semi-Annual Inspection & Maintenance Documentation	77
1. Service Visit Details	77
2. Visual Inspection (Detector & Mounting)	77
3. Environmental / Nuisance Source Review	78
4. Electrical & Network Checks	78
5. Functional Checks	79
6. Integrity of Logs, Events & Configuration	79
7. Cleaning & Preventive Maintenance	80
8. Findings & Corrective Actions	80
9. Service Confirmation	81
10. Acceptance	82
Appendix C: Planning Guide	83
General Purpose	83
Perform Site Survey and Risk Assessment	83
Determine Mounting Height	84
Determine Field of View (FOV)	84
Avoid Obstructions	84
Calibration and Testing	85
Pixels per Meter (ppm) at Distance	85
Appendix D: Manually Calibrating a Thermal Radiometry Sensor	86
Avoid Thermal Interference Around the Object	86
Determine the Emissivity of the Object's Surface	86
Determine the Atmospheric Temperature	87
Determine the Transmissivity of the Atmosphere	87
Test the Measurements Under Extreme Conditions	88

Before You Start

This section contains the following information:

Support	6
Safety Notes	7
Legal Notes	8
Intended Use	10

Support

MOBOTIX Support

If you need technical support, please contact your MOBOTIX dealer. If your dealer cannot help you, he will contact the support channel to get an answer for you as quickly as possible.

If you have internet access, you can open the MOBOTIX help desk to find additional information and software updates.

Please visit www.mobotix.com > [Services](#) > [Help Desk](#).



MOBOTIX eCampus

The MOBOTIX eCampus is a complete e-learning platform. It lets you decide when and where you want to view and process your training seminar content. Simply open the site in your browser and select the desired training seminar.

Please visit www.mobotix.com/ecampus-mobotix.



MOBOTIX Community

The MOBOTIX community is another valuable source of information. MOBOTIX staff and other users are sharing their information, and so can you.

Please visit community.mobotix.com.



Safety Notes

- This product must be installed by qualified personnel and the installation should conform to all local codes.
- This product must not be used in locations exposed to the dangers of explosion.
- Protect this product from moisture or water entering the housing.
- Install this product as outlined in this document. A faulty installation can damage the product!
- Do not replace batteries of the device. If a battery is replaced by an incorrect type, the battery can explode.

Mitigation of Environmental Influences on EN 54 Thermal Fire Detection

- Perform frequent (e.g. daily) visual checks when using this product in dusty, humid, or hot environments (e.g. waste, recycling, foundry areas).
- Systems exposed to weather, solar radiation, dust, or other environmental influences that could impair the proper functioning of the product (e.g. insects), may require frequent cleaning. After cleaning, make sure the systems still works as intended.
- Always run a short verification test after any maintenance or software update before returning the system to normal operation.

Legal Notes

Copyright Notice!

© 2025 MOBOTIX AG. All rights reserved.

This document and its contents are the property of MOBOTIX AG and are protected by applicable copyright laws. Any reproduction, distribution, modification, or use of this document, in whole or in part, without prior written permission of MOBOTIX AG is strictly prohibited.

All product names, trademarks, logos, and brands referenced in this document are the property of their respective owners. These may include, but are not limited to, trademarks and certification marks of third-party organizations. The use of such marks is for identification and informational purposes only and does not imply any affiliation with or endorsement by the respective trademark owners. MOBOTIX AG acknowledges the rights of all trademark holders and makes no claim to trademarks owned by third parties.

Special Export Regulations!

Cameras with thermal image sensors ("thermal cameras") are subject to the special export regulations of the U.S. and including the ITAR (International Traffic in Arms Regulation):

- According to current U.S. export control regulations, including the International Traffic in Arms Regulations (ITAR) and the Export Administration Regulations (EAR), thermal imaging cameras, sensors, and related components may be subject to export restrictions or licensing requirements depending on their technical characteristics and classification.
- Exports, re-exports, or transfers to comprehensively embargoed or sanctioned destinations are generally prohibited unless authorized by the relevant U.S. authorities. As of now, this includes, in particular: Crimea, Donetsk and Luhansk regions of Ukraine, Cuba, Iran, North Korea, and Syria.
- In addition, exports to certain countries such as Russia and Belarus are subject to extensive restrictions and, for many controlled items, are effectively prohibited.
- Furthermore, exports to any persons, entities, or organizations listed on U.S. government restricted party lists are prohibited. These include, but are not limited to, the Denied Persons List (DPL), the Entity List, and the Specially Designated Nationals (SDN) List, as maintained by the U.S. Department of Commerce and the U.S. Department of the Treasury.
- All exports must be reviewed on a case-by-case basis to ensure compliance with applicable U.S. export control laws and regulations.

- Under no circumstances must the camera itself or its thermal image sensors be used in the design, the development or in the production of nuclear, biological or chemical weapons or in the weapons themselves.

Legal Aspects of Video and Sound Recording

You must comply with all data protection regulations for video and sound monitoring when using MOBOTIX AG products. Depending on national laws and the installation location of the cameras, the recording of video and sound data may be subject to special documentation or it may be prohibited. All users of MOBOTIX products are therefore required to familiarize themselves with all applicable regulations and to comply with these laws. MOBOTIX AG is not liable for any illegal use of its products.

Declaration of Conformity

The products of MOBOTIX AG are certified according to the applicable regulations of the EC and other countries. You can find the declarations of conformity for the products of MOBOTIX AG on www.mobotix.com under **Services > Download Center > Marketing & Documentation > Certificates & Declarations of Conformity**.

RoHS Declaration

The products of MOBOTIX AG are in full compliance with European Unions Restrictions of the Use of Certain Hazardous Substances in Electrical and Electronic Equipment (RoHS Directive 2011/65/EU) as far as they are subject to these regulations (for the RoHS Declaration of MOBOTIX, please see www.mobotix.com, **Services > Download Center > Marketing & Documentation > Brochures & Guides > Certificates**).

Disposal

Electrical and electronic products contain many valuable materials. For this reason, we recommend that you dispose of MOBOTIX products at the end of their service life in accordance with all legal requirements and regulations (or deposit these products at a municipal collection center). MOBOTIX products must not be disposed of in household waste! If the product contains a battery, please dispose of the battery separately (the corresponding product manuals contain specific directions if the product contains a battery).

Disclaimer

MOBOTIX AG does not assume any responsibility for damages, which are the result of improper use or failure to comply to the manuals or the applicable rules and regulations. Our General Terms and Conditions apply. You can download the current version of the **General Terms and Conditions** from our website at www.mobotix.com by clicking on the corresponding link at the bottom of every page.

Before You Start

Intended Use

It is the User's responsibility to comply with all applicable local, state, national and foreign laws, rules, treaties and regulations in connection with the use of the Software and Product, including those related to data privacy, the Health Insurance Portability and Accountability Act of 1996 (HIPPA), international communications and the transmission of technical or personal data.

Disclaimer for EN 54 Thermal Fire Detection

All technical specifications, recommendations and procedural instructions contained in this guideline are based on the technical capabilities of the MOBOTIX Thermal Fire Detection (*TFD*) system and its associated components.

For all fire protection applications, the applicable regional and international standards, codes and certification requirements (such as EN 54, FM 3260 or VdS guidelines) take precedence. Installers and operators are responsible for ensuring that the system is designed, installed, configured and maintained in full compliance with these standards as well as with any local regulatory or insurance-specific provisions.

Intended Use

This EN 54 solution meets EN 54-10 (Class 1) and EN 54-18 requirements when installed and operated with the specified components.

EN 54-10 Class 1 verifies flame and heat detection performance up to 25 m/27.34 yd for the certified combinations (see [Verify Detection Distance, p. 24](#)). The camera is intended for early fire detection in environments with increased fire risk (e.g., waste management, recycling, warehousing).

NOTE! One additional optical sensor module can be added without losing the EN 54 certification (provided the thermal image sensor remains in place).

Introduction

This section contains the following information:

Purpose of the Guideline	12
Target Audience	12
Scope and Limitations	12
EN 54 Fundamentals	13

Purpose of the Guideline

This document provides professional installers with best-practice instructions for setting up and calibrating MOBOTIX thermal radiometry cameras for use as Thermal Fire Detection (*TFD*) systems. Its purpose is to ensure that cameras are positioned, configured, and verified in a way that delivers accurate temperature measurement and reliable heat detection in demanding environments. The guideline consolidates practical experience, technical recommendations, and verification methods into a structured reference to support successful installations.

Target Audience

The guideline is intended for professional installers, integrators, and safety technicians who are responsible for designing, installing and commissioning MOBOTIX TFD systems. A basic familiarity with video surveillance systems is assumed. While the content is written to be clear and accessible for both experienced and less experienced professionals working with thermal fire detection, only qualified and MOBOTIX-certified specialists should apply the procedures and configurations described in this document to ensure correct system design and compliance with all relevant standards.

Scope and Limitations

The scope of this document covers the following topics:

- Thermal calibration and distance compensation of MOBOTIX thermal radiometry cameras.
- Camera positioning best practices for industrial and waste management sites.
- Environmental considerations for indoor and outdoor use.
- Verification procedures using blackbody radiators, including their limitations.
- A practical installer checklist for validating the installation.

This guideline does **not** replace official MOBOTIX product documentation, national fire safety regulations or certification manuals. It focuses on thermal fire detection aspects and does not provide a full system integration guide (e.g., VMS configuration, networking or alarm management). Installers should always consult local standards, regulations and MOBOTIX product manuals alongside this guideline.

EN 54 Fundamentals

Thermal radiometry is the measurement of infrared radiation emitted by an object to determine its surface temperature. Every material above absolute zero emits thermal energy; the intensity and wavelength of this energy depend on the object's temperature and emissivity.

MOBOTIX thermal radiometry cameras use these principles to continuously monitor temperature patterns within their field of view. By defining regions of interest (ROIs) and applying calibrated radiometric measurement, the system can detect abnormal heat build-up long before visible flames or smoke appear.

Thermal Fire Detection vs. Conventional Fire Detection

Traditional fire detection technologies (e.g., smoke or flame detectors) often rely on visible signs of combustion. In industrial and waste management environments, such detectors may react too late or be compromised by dust, steam, or obstructed airflows.

Thermal Fire Detection (*TFD*) identifies critical temperature rises at an early stage. This allows proactive intervention before ignition or open fire develops.

Among others, TFD is suitable for these application scenarios:

- Waste storage sites, where self-heating processes can cause spontaneous ignition.
- Industrial sites, where machinery, conveyor belts or stored materials may overheat.
- Battery storage and recycling facilities, where overheating or damaged cells can rapidly escalate to fires or explosions.

By detecting heat rather than combustion, MOBOTIX TFD systems add a preventive layer of safety to fire protection concepts.

Key Terminology

To ensure consistent understanding, the following key terms are used throughout this guideline:

- **Emissivity:** A measure of how efficiently a material emits infrared radiation. Values range from 0 (perfect reflector) to 1 (ideal emitter). Correct emissivity settings are essential for accurate temperature measurement.

EXAMPLE: Batteries typically have metallic casings with low emissivity. Applying the correct emissivity value ensures that heat buildup on the casing is measured accurately.

- **Measurement Area:** A defined zone within the thermal image where the camera measures and evaluates temperatures. MOBOTIX TFD systems allow configuration of up to 20 measurement areas. After expansion with the corresponding camera app (e.g., MOBOTIX MxAdvancedRadiometry App), each of these zones can also be equipped with individual distance and emissivity parameters.
- **Spot Size:** The minimum sensor area that needs to be fully covered by the temperature hotspot to verify accurate measurement, determined by optics and distance.
- **Distance Compensation:** Infrared radiation weakens with distance. The camera allows installers to apply individual distance compensation per measurement area, ensuring reliable measurements across different monitoring ranges.
- **Thresholds/Thermal Level:** Predefined temperature values that trigger alarms when exceeded. Thresholds should be set high enough to avoid false alarms but low enough to catch early heating.

Thermal Calibration and Configuration

Accurate calibration and correct configuration are essential to ensure that MOBOTIX TFD cameras provide reliable early warning of abnormal heat build-up. While positioning defines what the camera can see, calibration ensures that the measured temperature values in each measurement area are meaningful and trustworthy.

Scope of Delivery

This section contains the following information:

M73 EN54 Bundle-V2: Scope of Delivery	16
Mx-M73A: Scope of Delivery	17
Connector Box RJ45: Scope of Delivery	18
Mounting Supplies: Scope of Delivery	19
Mx-4IOA-Box: Scope of Delivery	20
Mx-NPAA-Box: Scope of Delivery	21

M73 EN54 Bundle-V2: Scope of Delivery



Scope of Delivery M73 EN54 Bundle-V2

Item	Count	Description
1.1	1	Pre-mounted Mx-M73A (includes camera, one Thermal TR sensor, Multisense module, and Mx-O-M7SA-Blind blind module)
1.2	1	Mx-F-4IOA (weatherproof connection of external sensors and switching of external devices via MOBOTIX cameras)
1.3	1	Mx-CBL-MUC-MU-1 USB cable 1 m/3.28 ft for connecting camera to Mx-F-4IOA
1.4	1	Mx-F-NPAA (weatherproof PoE injector (IEEE 802.3af) and network connector)
1.5	1	Important Safety Information

Mx-M73A: Scope of Delivery



Scope of delivery Mx-M73A

Item	Count	Description
1.1	1	M73 Camera pre-assembled with Thermal TR module, Multisense module, and blind module
1.2	1	Mounting plate with wall sealing, two standard plugs (installed), and RJ45 connector box.
1.3	1	MOBOTIX Ethernet patch cable, 50 cm/19.7 in with sealing
1.4	1	SD card 8 GB (installed), max. 2 TB supported
1.5	1	Mounting supplies (see Mounting Supplies: Scope of Delivery, p. 19)
1.6	1	Important Safety Information

Connector Box RJ45: Scope of Delivery

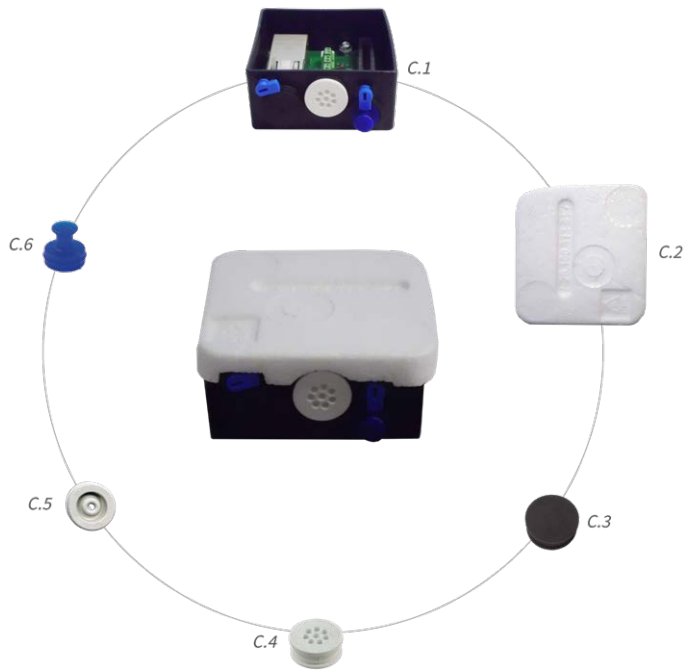

Scope of Delivery M73 Connector Box RJ45

Item	Count	Description
C.1	1	Connector box RJ45 black with rubber plug black, rubber plug single-wire white, USB plug blue (installed)
C.2	1	Protective cover for connector box polystyrene white (installed)
C.3	1	Rubber plug black (installed)
C.4	1	Rubber plug single-wire white (installed)
C.5	1	Rubber plug cable dia. 3.5 mm white (to replace C.5)
C.6	1	USB plug connector box blue (installed)

Mounting Supplies: Scope of Delivery



Fig. 1: Scope of Delivery MOBOTIX M73 Mounting Supplies

Scope of Delivery M73 Mounting Supplies

Item	Count	Description
M.1	1	Module wrench
M.2	1	Lens wrench
M.3	3	Housing plug silicone white
M.4	3	Security clips plastic red
M.5	2	Cable tie black
M.6	1	Allen wrench 5 mm
M.7	1	Allen wrench 2.5 mm
M.8	1	TORX wrench TX20
M.9	1	TORX wrench TX10
M.10	1	Screwdriver yellow

Scope of Delivery

Mx-4IOA-Box: Scope of Delivery

Scope of Delivery M73 Mounting Supplies

Item	Count	Description
M.11	4	Washer dia. 6.4 mm plastic white
M.12	4	Wood screw 4.5x60 mm
M.13	4	Dowel S8
M.14	3	Oval head screw with shank 2.5x6.5 mm stainless steel black (pre-assembled)
M.15	2	Cover for screw plastic white

Mx-4IOA-Box: Scope of Delivery

Count	Part Name
1	Mx-4IOA-Box Order Code: Mx-F-4IOA
2	Stainless steel PZ head screws 4 x 40 mm
2	Stainless steel washers
2	Plastic dowels
1	Screwdriver, small, blue
4	Silicone rubber plugs, white
2	Cable ties



Mx-NPAA-Box: Scope of Delivery

Count	Part Name
1	Mx-NPAA-Box Order Code: Mx-F-NPAA
2	Stainless steel PZ head screws 4 x 40 mm
2	Stainless steel washers
2	Plastic dowels
1	Screwdriver, small, blue
3	Silicone rubber plugs, white
1	Cable tie



Planning

This section contains the following information:

Considerations Before Installing	24
Best Practices for Camera Positioning and Sensor/Lens Selection	27

Considerations Before Installing

Site Assessment – Indoor and Outdoor

Before installation begins, a thorough site assessment is essential. The effectiveness of thermal fire detection depends on camera placement, environmental conditions, and the type of materials to be monitored.

Define Monitoring Objectives

1. Define critical areas and assets. These may include waste bunkers, conveyor belts, battery storage racks, or industrial machinery. Later, all relevant surfaces and assets must be fully covered by the field of view of the TFD systems.
2. Clarify the detection objective of the system:
 - Identify early heat build-up in waste piles?
 - Detect overheating of mechanical parts?
 - Provide preventative monitoring of high-risk storage areas?
3. Set the priorities, as not every zone requires the same level of sensitivity. Measurement areas should focus on locations where fire initiation is most likely.
4. Define the temperature values for triggering pre-alarm and alarm events.

Verify Detection Distance

The detection distances specified below have been verified in corresponding standardized tests as part of the EN 54 certification. These distances do not necessarily represent the technical limit of the MOBOTIX TFD, but are based on standard-specific requirements (including individual sizes of the reference sources) and test conditions.

Sensor	EN 54	FM 3260
640R050	25 m/27.3 yd	50 m/54.68 yd

Detection Distances for Tested Fuels as Verified by FM

Fuel	Remarks	Distance
N-Heptane		50 m/54.68 yd
Ethanol	99.8% pure	50 m/54.68 yd
Charcoal*	6 x 4 x 2 cm/2.36 x 1.57 x 0.79 in (single piece)	40 m/43.74 yd
Wood brick*	16 x 14 x 6 cm/6.30 x 5.51 x 2.36 in (single piece)	50 m/54.68 yd
Brown coal brick*	7 x 5 x 4 cm/2.76 x 1.97 x 1.57 in (single piece)	50 m/54.68 yd

*Material test involved one hour for pre-burn

NOTE! Successful acceptance and commissioning in accordance with the standard is expressly not limited to the distances specified in the lab reports.

Respect Maximum Cable Lengths

When planning the system layout, make sure to respect the maximum cable lengths as set in the following table.

Connection From	Connection To	Cable Type	Max. Length
Mx-M73A	Mx-F-NPAA	MOBOTIX patch cable	10 m/32.81 ft
Mx-M73A	Mx-F-4IOA	MOBOTIX USB cable Mx-CBL-MUC-MU-1, or Mx-CBL-MUC-MU-5	5 m/16.40 ft
Mx-F-NPAA	Router/switch with/without PoE Plus (802.3at-2009)/Class 4	Standard network cable	90 m/98.42 yd
Mx-F-4IOA	FACU/P (Fire Alert Control Unit/Panel)	J-Y(ST)Y 2x2x0.8	150 m/164.04 yd

NOTE! For more information on maximum cable lengths, see [Wiring Overview, p. 32](#).

Indoor Environments

- Identify permanent heat sources such as ovens, heaters, overhead cranes, or lighting, as they can influence measurements.
- Identify air conditions like dust, steam, or hot air currents that may temporarily obscure the view or distort readings.

Outdoor Environments

- Consider the sun's position throughout the year. Cameras should not face low-angle sunlight, which can cause reflections and glare.
- Consider protective measures if weather conditions such as fog, rain, snow, or high humidity can be present. These factors reduce infrared contrast and can shorten effective monitoring distance.
- Prevent blind spots and select a suitable camera position if the shape of an object of scene can change over time (e.g. a waste pile).
- Working areas of vehicles like trucks, wheel loaders, and cranes should not be included in measurement areas, as they may lead to false alarms. Where movement is unavoidable, the *MOBOTIX MxThermalValidation* app should be included as part of the system design.
- Hot surfaces, metal objects or water puddles can reflect sunlight and distort measurements. Careful camera positioning, smart planning of measurement areas, and the deployment of the *MOBOTIX MxThermalValidation* app can reduce the impact of this effect.

EN 54-4-Compliant Power Supply/Power Consumption

EN 54-4 requires stable, monitored power with appropriate autonomy and battery management. Plan power and battery capacity according to overall system consumption and autonomy targets. Pay special attention to these requirements.

- Output characteristics: Stable output voltage; ripple and noise limits to avoid interference.
- Redundancy: Provide redundant power and automatic switchover on primary failure.
- Battery capacity and autonomy: Size batteries for load and required backup duration.
- Charging circuits: Maintain optimal charge, including temperature compensation; avoid overcharging and undercharging.
- Monitoring: Continuous monitoring of voltage, current, and temperature with alarms for critical conditions.

Power Consumption

CAUTION!

To comply with the requirements of EN 54-4, the entire fire detection system (cameras, alarm systems, etc.) must be protected by uninterruptible power supplies (UPS) or batteries that can bridge power outages of up to 72 hours!

Search for "Standby supply" in the EN 54-4 standards document.

M73 EN54 Bundle-V2

Components	Average Power Consumption	Max. Power Consumption
<ul style="list-style-type: none"> ■ Mx-M73A ■ M1: Thermal Image Sensor ■ M3: Multisense ■ Mx-F-4IOA ■ Mx-F-NPAA 	<ul style="list-style-type: none"> ■ 12.5 W/520 mA at 24 VDC 	<ul style="list-style-type: none"> ■ Max. 25 W/1042 mA at 24 VDC

M73 EN54 Bundle-V2 and D/N Image Module

Components	Average Power Consumption	Max. Power Consumption
<ul style="list-style-type: none"> ■ Mx-M73A ■ M1: Thermal Image Sensor ■ M2: Day/Night sensor module ■ M3: Multisense ■ Mx-F-4IOA ■ Mx-F-NPAA 	<ul style="list-style-type: none"> ■ 13.5 W/562 mA at 24 VDC 	<ul style="list-style-type: none"> ■ Max. 25 W/1042 mA at 24 VDC

Best Practices for Camera Positioning and Sensor/Lens Selection

Correct camera positioning is crucial for reliable Thermal Fire Detection (TFD). A poorly positioned camera cannot be corrected later by software or calibration. The following best practices ensure that MOBOTIX thermal radiometry cameras achieve the best coverage and accuracy.

Mounting Height and Angle Recommendations

1. **Mounting Height:** Install the camera at a height where it has the most unrestricted view possible of the objects/area to be monitored (e.g., immovable obstacles or passing vehicles), where it is well protected against vandalism and external manipulation, and where you still have the best possible view of the camera's service LEDs.

Unnecessarily high installation should be avoided for these reasons:

- The distance to the object to be monitored increases.
 - Accessing the device for service becomes more difficult.
2. **Angle of view:** Position cameras at a slight downward angle (10 to 40°, depending on the mounting height) to reduce reflections from flat surfaces and to improve coverage depth. Avoid extreme angles that cause the visible surface of objects to become smaller for the camera.
 3. **Accessibility:** Choose mounting positions that remain reachable for re-alignment, cleaning, or replacement.

NOTE! See the [Planning Guide, p. 83](#) for more information on mounting height, angle of view, etc.

Field-of-View Optimization

- Ensure that all critical zones are fully within the thermal image. The opening angle of the thermal module should be selected accordingly.
- Avoid blind spots where heat build-up could remain undetected.
- Use multiple measurement areas (up to 20 per camera) to divide large scenes into manageable zones with tailored parameters and potentially individual associated action plans.
- Overlapping fields of view between cameras can increase reliability in large or complex installations.

Sensor and Lens Selection

Sensor and lens choice defines the area that can be monitored and the distance in which temperature events can be reliably detected. The currently available radiometry options are the following:

- **Sensor Module: B336R100**
 - Resolution: CIF 336 × 256 px
 - Field of View: 45° H × 35° V
 - Use Case: Broad coverage of waste and recycling yards, industrial halls, and outdoor areas.

■ Sensor Module: B336R150

- Resolution: CIF 336 × 256 px
- Field of View: 25° H × 19° V
- Use Case: Broad coverage of waste and recycling yards, industrial halls, and outdoor areas.

■ Sensor Module: B336R280

- Resolution: CIF 336 × 256 px
- Field of View: 17° H × 13° V
- Use Case: Broad coverage of waste and recycling yards, industrial halls, and outdoor areas.

■ Sensor Module: B640R050

- Resolution: VGA 640 × 480 px
- Field of View: 90° H × 69° V
- Use Case: Broad coverage of waste and recycling yards, industrial halls, and outdoor areas.

■ Sensor Module: B640R080

- Resolution: VGA 640 × 480 px
- Field of View: 69° H × 56° V
- Use Case: Broad coverage of waste and recycling yards, industrial halls, and outdoor areas.

■ Sensor Module: B640R100

- Resolution: VGA 640 × 480 px
- Field of View: 45° H × 37° V
- Use Case: Broad coverage of waste and recycling yards, industrial halls, and outdoor areas.

■ Sensor Module: B640R150

- Resolution: VGA 640 × 480 px
- Field of View: 32° H × 26° V
- Use Case: Broad coverage of waste and recycling yards, industrial halls, and outdoor areas.

Installation

This section contains the following information:

Wiring Overview	32
Installing the Components	33

Wiring Overview

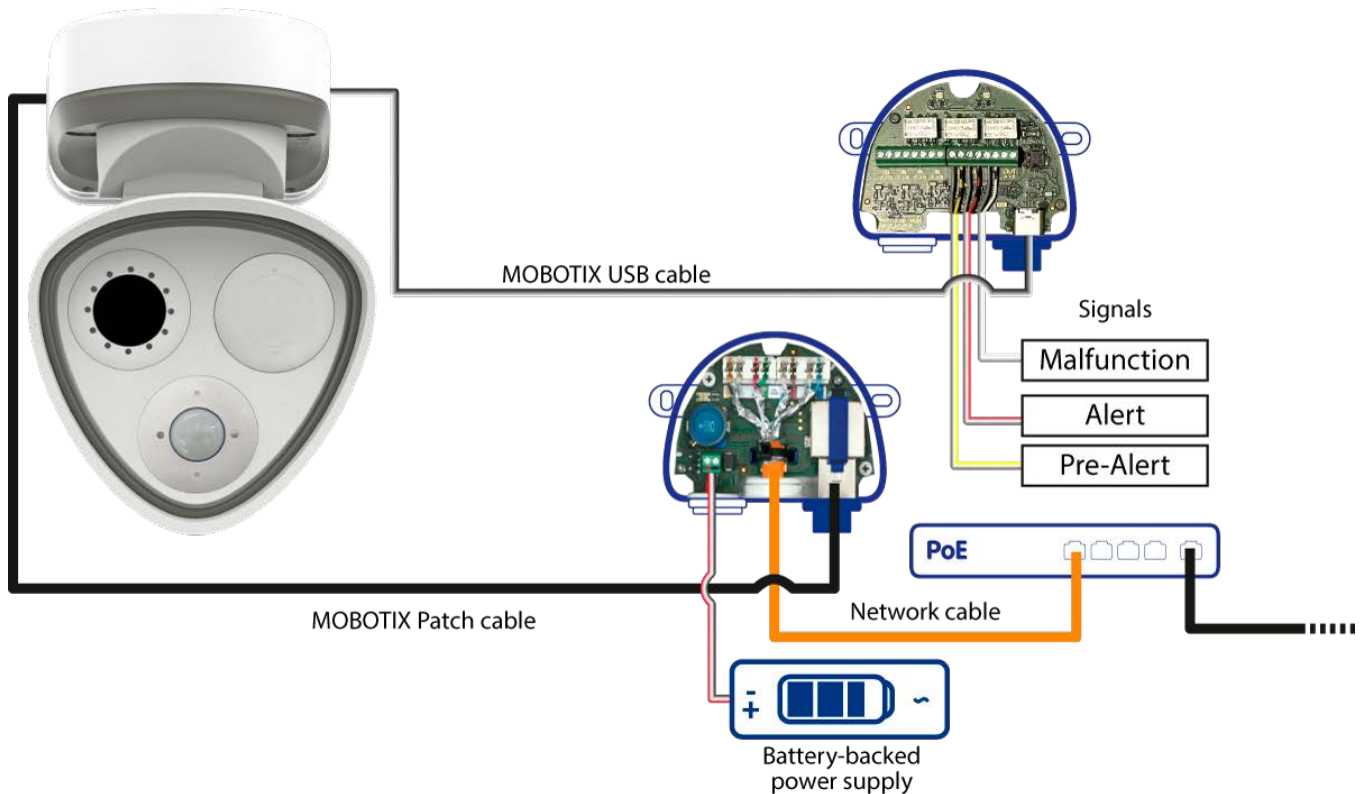

Fig. 2: Wiring of the M73 EN54 Bundle-V2

NOTE!

- Power supply must conform to EN 54-4; the PoE switch must provide PoE Plus (802.3at-2009)/Class 4.
- Max. network cable length between camera and router/switch (with/without PoE power supply) is 100 m/109.36 yd.
- The supplied MOBOTIX USB cable Mx-CBL-MUC-MU-1 (see [Scope of Delivery, p. 15](#)) for connecting the camera to the Mx-F-4IOA is 1 m/3.28 ft long. Optional cable Mx-CBL-MUC-MU-5 (5 m/16.40 ft) can be ordered separately.
- For connection to the FACU (*Fire Alert Control Unit*, also referred to as *FACP Fire Alert Control Panel*), J-Y(ST)Y 2x2x0.8 should generally be planned with a conservative line length of up to 150 m/164.04 yd. Greater lengths shall only be implemented if verified by line calculation and approved against the electrical specifications of the detector interface and the FACP input. The permissible line length is determined in particular by loop resistance, voltage drop, line capacitance, end-of-line monitoring, shielding/grounding concept and EMC-compliant cable routing.

CAUTION! EN 54 stipulates that fire-resistant cabling must be used in areas that can be exposed to heat. Since most of the cables are MOBOTIX cables (with integrated sealings), it is recommended to use fire-resistant cable ducts in areas exposed to heat.

Installing the Components

CAUTION!

To ensure EN 54 conformity, only original MOBOTIX components may be used!

NOTE!

One additional optical sensor can be optionally added without losing the EN 54 certification.

For more information on installing the individual components of the Mx-M73TA-EN54-V2 system, please refer to the documents listed below.

Documentation for Components of M73 EN54 Bundle-V2

Mx-M73A

Quick Installation



<https://www.mobotix.com/media/3068>

Drilling Template



<https://www.mobotix.com/media/3066>

Mx-F-4IOA

Quick Installation/Technical Specifications



<https://www.mobotix.com/media/6227>

Mx-F-NPAA

Quick Installation/Technical Specifications



<https://www.mobotix.com/media/6228>

Notes on Installing Components

- Mount the components only on flat surfaces (max. unevenness 0.5 mm).
- Use genuine MOBOTIX patch cables and connectors to maintain IP rating.
- One additional optical sensor module may be added without losing EN 54 compliance (with the thermal module remaining in place).

Initial Commissioning

This section contains the following information:

Initial Camera Setup	36
Storing the Camera Configuration	47
Verification and Functional Testing	48
Handover to Customer	52

Initial Camera Setup

Check the Preconditions

- Is the camera running (check camera power LED)?
- Is the camera accessible using my current network connection?
- Do I have the necessary information for successfully running the camera on the network?
 - IP address of NTP (*Network Time Protocol*) server.
 - IP address of network gateway (if required).

Access the Camera

1. Start your web browser.
2. Access the camera using its zeroconf address:
 - Look for the factory IP address such as `10.x.y.z` on the sticker on the camera body or the packaging.
 - Enter this address in the address bar of your browser using the following syntax: `m \times 10-x-y-z.local`.

EXAMPLE: Taking a factory IP address of `10.32.24.129` as an example, you would enter `m \times 10-32-24-129.local` in the address bar of your browser.

- In the *Live* view, open the camera menu .
- Click on **Admin Menu** and enter the default access credentials (`admin/meinsm`).

3. In the **Quick Installation** dialog, select your language, then click on .



4. Continue clicking on  and do not change any settings until you reach the **Security** dialog.
Set a password for the admin user of the camera. Make sure you keep the password in a safe place.

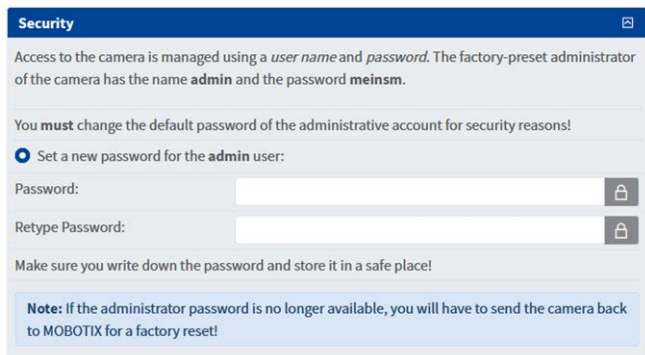

NOTE! Make sure to record the new password in the system documentation!

5. Continue clicking on  and do not change any settings until you reach the **Country Settings** dialog.
Check the time zone and adjust it, if necessary.

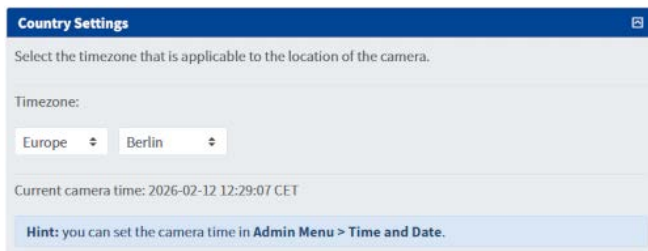

Initial Commissioning

Initial Camera Setup

- Click on  and in the **Audio Settings** dialog, activate the devices that are available for this camera.

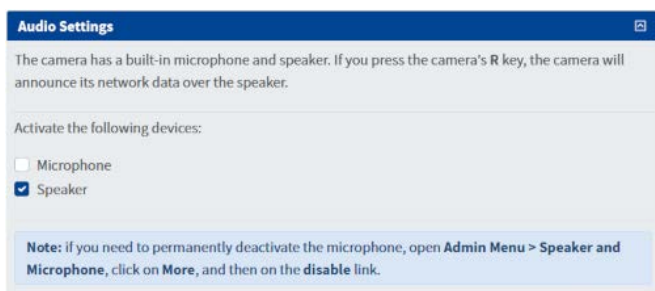

- Click on  and in the **Camera Name** dialog, enter a descriptive camera name.

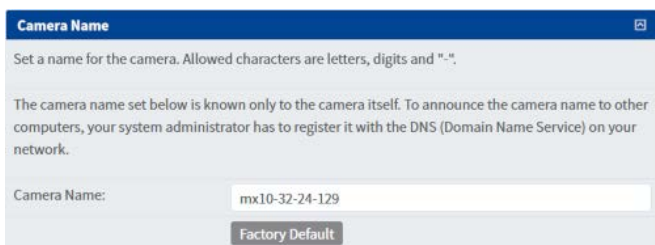

NOTE! Make sure to record this camera name in the system documentation!

- Continue clicking on  and do not change any settings until you reach the **Time Server** dialog. Enter the IP address of your network time servers as provided by your network administrator (e.g. 192.168.1.1 ptbtime1.ptb.de; use spaces to separate multiple addresses).

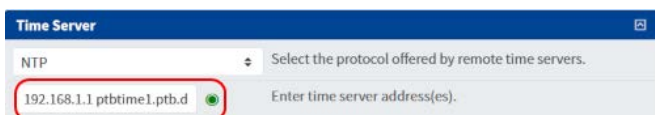

If the time server is working properly, the LED to the right of the field turns green. A red LED indicates that the server does not work properly.

- Click on  and review the information in the **Store Configuration** dialog. If everything is correct, print the page and include it in the system documentation.

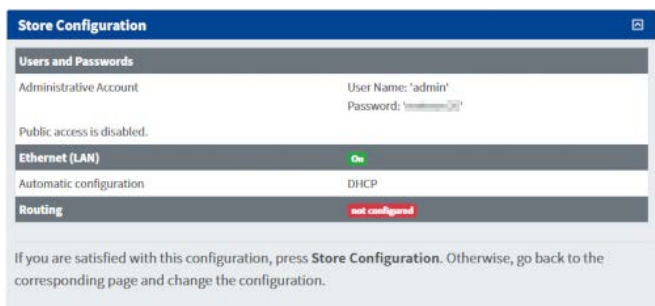

- Click on **Store Configuration** and then on **Reboot**.

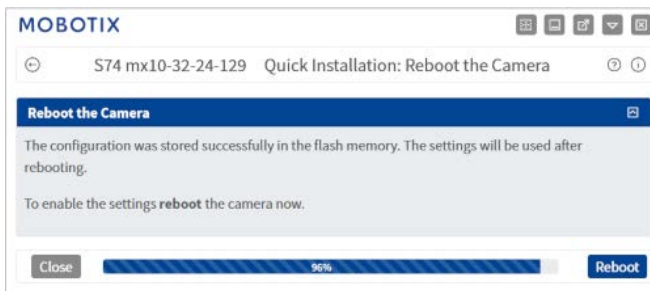

- Enter the new password you entered in the **Security** dialog when prompted by the camera. The camera will now reboot; once it is working again, you will see its live image.

Find the "Real" IP Address of the Camera

Since you are still using the `mx10-32-24-129.local` zeroconf address, you need to find out the actual IP address of the camera.

- Click on the **Show Camera Status** icon (i).
- In the **Camera Status** dialog, click on **Networking**.
 - The **Camera Name** entry shows the camera's current fully qualified domain name.
 - The **BOOTP/DHCP** status *Client running, got a lease* shows that the camera properly received an IP address.
 - The **IP Address** entry shows the camera's current address.
- You can use either the **Camera Name** (e.g. `mx10-32-24-129.fritz.box`) or the IP address (e.g. `192.168.1.210`) to access the camera from now on.
- Open a new browser tab and enter the address (e.g. `mx10-32-24-129.fritz.box` or `192.168.1.210`), then enter the access credentials (`admin/<your new password>`).

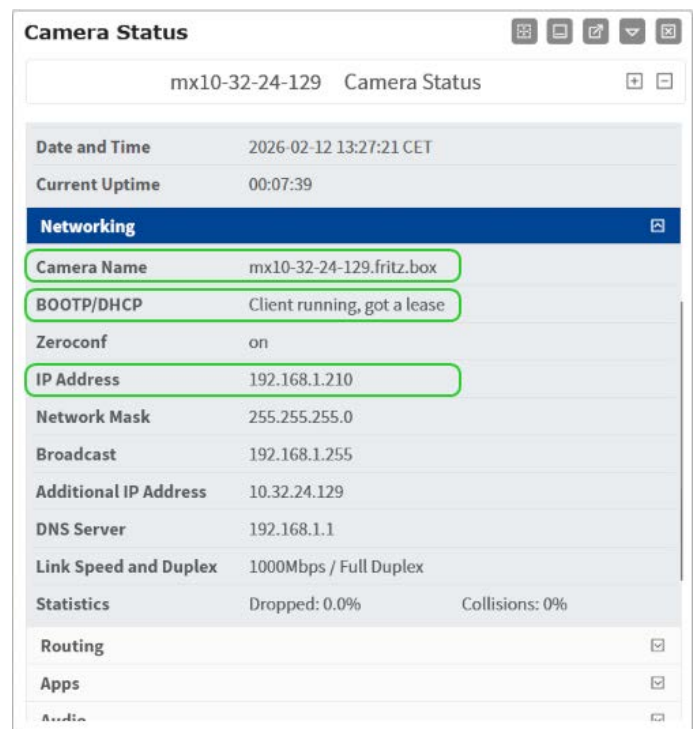

NOTE! Make sure to record this address in the system documentation together with the camera name!

Thermal Calibration and Configuration

Accurate calibration and correct configuration are essential to ensure that MOBOTIX TFD cameras provide reliable early warning of abnormal heat build-up. While positioning defines what the camera can see, calibration ensures that the measured temperature values in each measurement area are meaningful and trustworthy.

Follow the steps below to ensure that the camera delivers the best results for detecting heat sources according to the project requirements.

Adjust Object Emissivity

Object Emissivity describes how efficiently a material emits infrared radiation. Values range from 0 (perfect reflector) to 1 (ideal emitter).

- Thermal cameras do not measure temperature directly—they measure emitted infrared energy.
- The camera uses the emissivity value to convert detected radiation into a temperature reading.

Why it Matters for EN 54 Systems

- Incorrect emissivity settings can lead to wrong temperature readings:
 - Too low → temperature appears lower than actual
 - Too high → temperature appears higher than actual
- This directly impacts:
 - Fire detection thresholds
 - Hotspot detection accuracy
 - False alarm rates

Typical Implications

- Shiny metal surfaces may mask overheating (dangerous false negatives)
- Mixed materials in a scene require careful calibration or compensation
- Certified systems often use:
 - Fixed emissivity assumptions
 - Or application-specific calibration

Recommended Solution

- Most natural surfaces (wood, waste material, concrete) have high emissivity values between 0.8 and 0.95. Metals and reflective materials (e.g. polished steel, aluminum, chrome surfaces) often have much lower values (0.1 to 0.3).

- For fire detection, it is recommended to use realistic emissivity values for the monitored material and to avoid placing measurement areas on low-emissivity objects whenever possible.
- If reflective surfaces cannot be avoided, consider adjusting the viewing angle to minimize reflections or use the MOBOTIX MxThermalValidation app to minimize the risk of false alarms by differentiation of real temperature events from reflections.

NOTE!

- See the [Thermal Emissivity Table](#) on the MOBOTIX website for a list of emissivity values. If you are looking for other materials, search for "emissivity values" on the web.
- When in doubt, use 0.90 as a safe default emissivity value for mixed waste or most non-metallic, matte or coated surfaces.



Adjust Atmospheric Transmission

Atmospheric transmission refers to how much infrared (thermal) radiation passes through the air between the target and the thermal camera without being absorbed or scattered.

- Thermal cameras detect heat (infrared radiation), but the atmosphere (air, smoke, humidity, dust, gases) can reduce the signal.
- Atmospheric transmission is usually expressed as a percentage (0–100%):
 - 100% = perfect clarity (no loss)
 - Lower values = more absorption/scattering → less accurate temperature readings

Why it Matters for EN 54 Systems

- Fire detection reliability depends on accurately sensing heat sources.
- Poor atmospheric transmission (e.g., heavy smoke, fog, steam) can:
 - Delay detection
 - Reduce measured temperatures
 - Affect alarm thresholds

1.

Adjust Ambient Temperature

Ambient temperature is the temperature of the surrounding environment in which the thermal camera and monitored scene are located.

- Ambient temperature includes air temperature around:
 - The camera
 - The monitored area (room, warehouse, outdoor site)

Why it Matters for EN 54 Systems

- Ambient temperature affects:
 - Camera calibration (thermal cameras compensate for environment temperature)
 - Detection thresholds (what counts as “abnormal heat” depends on baseline temperature)
- High ambient temperatures can:
 - Reduce contrast between fire and background
 - Increase risk of false negatives
- Low ambient temperatures can:
 - Increase contrast → earlier detection

Thermal Sensor Settings Dialog

The screenshot shows the 'Thermal Sensor Settings' dialog for a camera model 'S74 mx10-32-24-129'. The dialog is titled 'MOBOTIX' and includes several settings:

- Temperature Compensation:** A checkbox that is checked. Description: 'enable manual mode in order to use [thermal nonuniformity](#) events. Factory default: *On*'.
- Manual Configuration:** A checkbox that is unchecked. Description: 'Enable the manual configuration of the parameters for temperature compensation. Note: If disabled, the factory default settings of these parameters (a scene with 100% emissivity in close proximity to the camera) are applied. Factory default: *Off*'.
- Object Emissivity:** A dropdown menu set to '95'. Description: 'Specify the emissivity of the object in percent. Note: See the [Emissivity Table](#) for emissivity values of typical materials. Factory default: *100*'.
- Atmospheric Transmission:** A dropdown menu set to '100'. Description: 'Specify the transmission coefficient of the area between the object and the camera in percent. Factory default: *100*'.
- Ambient Temperature:** A dropdown menu set to '22'. Description: 'Specify the temperature of the area between the object and the camera in degrees Celsius with a resolution of 0.1°C. Note: This parameter only has an effect if *Atmospheric Transmission* is set to a value less than 100%. Factory default: *22*'.

At the bottom of the dialog, there are buttons for 'Set', 'Factory', 'Restore', 'Close', and 'Less'.

Fig. 3: Example configuration of global emissivity values in Setup Menu > Image Control > Thermal Sensor Settings.

NOTE! The *Emissivity Table* hyperlink in the description for **Object Emissivity** also takes you to an online help page listing common materials and their typical emissivity values.

CAUTION! When using the advanced radiometry settings in MOBOTIX thermal camera apps (*MxAdvancedRadiometry*, *MxThermalValidation*), the global radiometry settings must not be changed (leave at default settings).

Define Measurement Areas

1. Every camera can be configured with up to 20 independent measurement areas.
2. Large monitoring areas should be divided into smaller measurement areas so that each area can be fine-tuned for its specific conditions.
3. It is good practice to align measurement areas with actual risk zones: for example, the surface of a waste pile, the loading zone of a conveyor or a rack of batteries.
4. Deploying the *MxAdvancedRadiometry* or the *MxThermalValidation* app enables to assign each measurement area its individual emissivity value instead of applying one global value, thus allowing even more accurate monitoring of different materials within the same field of view.

Add Distance Compensation

- Infrared radiation weakens with distance. Distance compensation as one of the available calibration adjustments ensures that temperature readings remain accurate even for objects further away.
- It is common that TFD systems cover large areas with a variety of risk areas or objects to be measured. In outdoor waste yards, for example, one camera may cover both nearby conveyor belts and distant waste piles. In such cases, each measurement area should be assigned its own distance value.
- This flexibility allows one camera to monitor both near and far objects without compromising measurement accuracy.

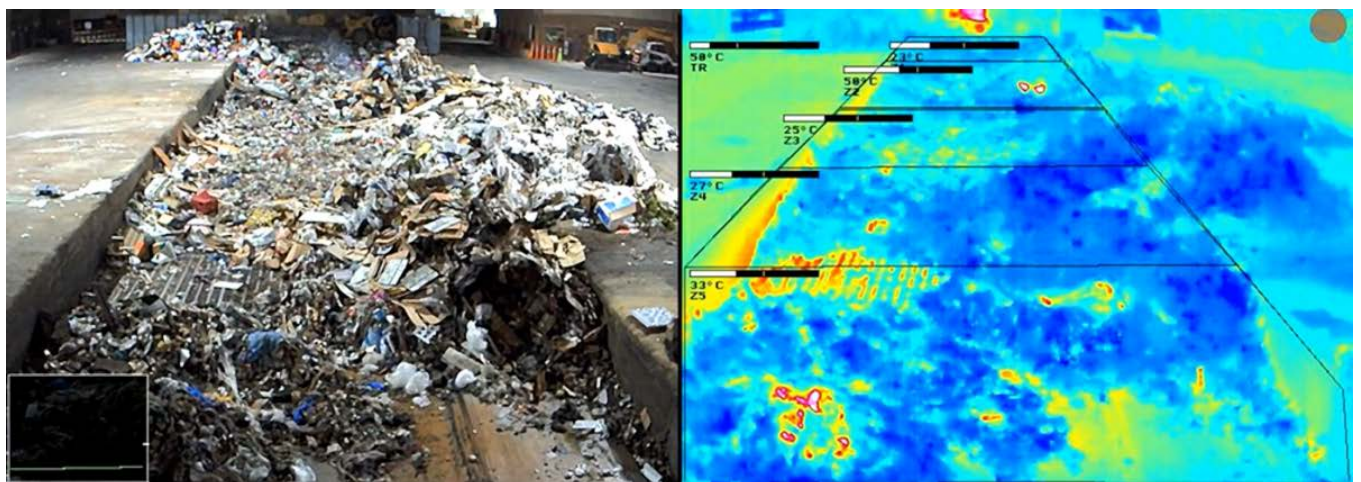

Fig. 4: TFD as a preventive measure in a recycling plant using stacked measurement areas with individual distance compensation for accurate measurement.

Advanced sensor parameters <input checked="" type="checkbox"/>	
Emissivity	90
Humidity	74
Distance	15
Background temperature (°C or °F)	20
Atmospheric temperature (°C or °F)	22

Fig. 5: Additional individual measurement area settings using the MOBOTIX MxAdvancedRadiometry and MxThermalValidation apps.

Set Alarm Thresholds

Alarm thresholds define the temperatures at which the MOBOTIX TFD system reacts to abnormal heat buildup. Correctly selected thresholds are crucial for early detection while avoiding unnecessary false alarms.

- Alarm thresholds should be chosen above normal operating conditions but below ignition risk levels, ensuring early warning without excessive false alarms.
- A common best practice is to configure multistage alarms so operators can react before a critical condition develops and before the full emergency procedure is triggered.

EXAMPLE:

- Pre-alarm radiometry event at 70°C/158°F (early warning): Notifies operators of unusual heating.
- Main alarm radiometry event at 100°C/212°F (critical): Triggers automatic or manual response procedures.

- Thresholds should always be adapted to the site and the monitored materials rather than copied across different installations.
- Avoid setting thresholds too close to normal temperature fluctuations. A safety margin of +10°C/+18°F above the maximum expected background temperature is recommended.

In MOBOTIX TFD systems, two overlapping radiometry event profiles are defined in **Setup Menu > Event Control > Event Overview > Environmental Events**. They are configured as follows:

- Two independent thermal radiometry event profiles are created for the same measurement area: *Pre-Alarm* and *Main Alarm*.

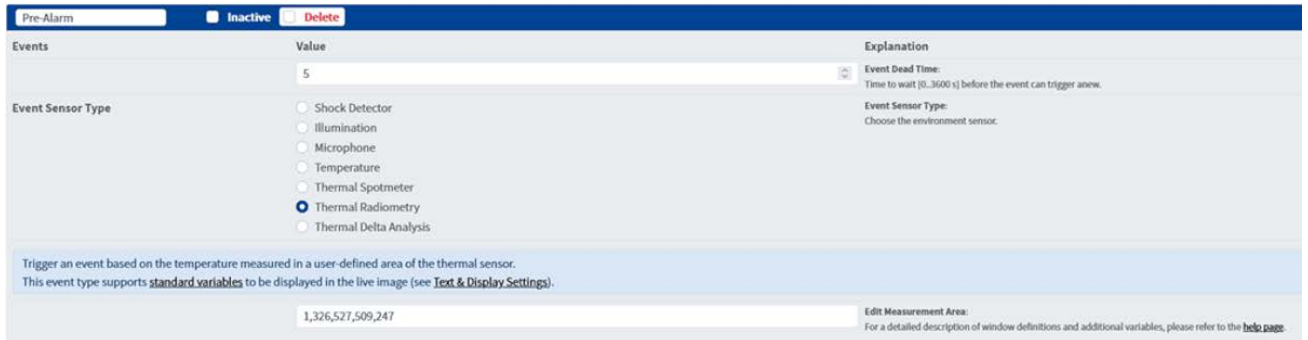

Fig. 6: *Pre-Alarm* radiometry event profile with measurement area.

- Define your measurement area in one of the profiles and copy the coordinates to the second profile so the two zones have identical measurement areas.



Fig. 7: *Pre-Alarm* radiometry event profile settings.

- Define individual temperature thresholds for both profiles (e.g. *Pre-Alarm* at 70°C/158°F, *Main Alarm* at 100°C/212°F) according to the intended behavior of the TFD system.

Adjusting the Configuring of the Camera to the Scene

This section provides an overview of the steps required to adapt a MOBOTIX camera for fire detection according to EN 54. The camera is assumed to be installed, powered, and fully accessible via the user interface.

NOTE! The configuration must be adapted to the specific environmental conditions and the area to be monitored. Proper setup is essential to ensure reliable fire detection.

1. Verify Installation and Field of View

Before adjusting detection parameters, ensure that the physical installation supports reliable monitoring of the protected area.

- Confirm that the camera position provides full coverage of the defined detection zone.
- Ensure there are no permanent obstructions within the field of view.

- Avoid strong backlight, reflections, or direct sunlight where possible.
- Check focus and image clarity.

2. Define the Detection Area

Restrict fire detection to the relevant parts of the scene to avoid false alarms.

- Open the fire detection or thermal detection configuration menu.
- Define the monitoring area (region of interest).
- Exclude irrelevant zones such as moving machinery, light sources, or heat-emitting equipment.
- Save and verify the defined detection region.

3. Adjust Detection Sensitivity

Sensitivity must be adapted to the environmental conditions and the fire risk level.

- Select an appropriate detection profile, if available.
- Adjust sensitivity levels according to the size of the area and expected fire characteristics.
- Consider environmental influences such as dust, steam, or temperature variations.
- Apply changes and monitor system behavior.

4. Configure Alarm Handling

Ensure that detected events trigger the appropriate alarm actions.

- Configure alarm notification settings (e.g., relay output, network message, VMS integration).
- Define escalation procedures if required.
- Verify communication with connected fire alarm systems.

5. Perform Functional Testing

After completing configuration, validate the setup under realistic conditions.

- Simulate a test scenario in accordance with local safety regulations.
- Verify that detection is triggered within the expected response time.
- Confirm that alarm outputs function correctly.
- Document the configuration and test results.

6. Monitor and Optimize

After commissioning, monitor system performance and adjust settings if necessary.

- Review alarm logs regularly.
- Identify potential false alarms and adjust detection areas or sensitivity.
- Re-validate the configuration after environmental or structural changes.

NOTE! For compliance with EN 54, always follow applicable national regulations and certification requirements.

Storing the Camera Configuration

Permanently Store the Configuration

CAUTION!

After configuring, you need to store the configuration to the camera's permanent memory. Skipping this step will return the camera to its default or the last stored configuration when rebooting.

1. In the *Live* view, open the camera menu ☰.
2. Click on **Admin Menu > Configuration > Store**.
3. Click on **Store Permanently**.

Save the Configuration File

CAUTION!

It is highly recommended to save the configuration file in a safe place on your computer or network. You can thus easily restore the configuration of a damaged or stolen camera, for example.

1. In the *Live* view, open the camera menu ☰.
2. Click on **Admin Menu > Configuration > Save**.
3. Select a suitable folder on your computer and save the file.

Verification and Functional Testing

Verification ensures that the TFD system performs according to design and detects real temperature events under controlled conditions. It should be carried out after commissioning and repeated during maintenance intervals.

Regarding the TFD system, the verification should cover the following action points:

- Verification of the correct installation, positioning and alignment of the thermal sensor.
- Confirmation of the correct positioning and calibration of all configured measurement areas.
- Confirmation of the correct definition of the alarm thresholds for pre-alarm and main alarm.
- Validation of the alarm response at predefined threshold temperatures.
- Optional: Testing the system for behavior in expected false alarm scenarios (e.g. passing vehicles) and potential system errors.

Verification of Temperature Accuracy and Threshold Alarms

For reliable measurement and alarm validation, the performance of the MOBOTIX TFD system must be verified against a defined radiating reference source.

Internationally recognized laboratories such as VdS define this reference source as a homogeneous, uniformly heated radiation surface with a defined target temperature. Ideally, the size of the reference source should be selected to match the pixel spot of the TFD sensor and the target distance of the object to be measured. The surface temperature is measured with a standardized infrared thermometer and compared to the readings of the thermal camera when testing. This procedure ensures that the camera's temperature measurement accuracy and calibration are within the expected tolerance range.

Practical Reference Sources

In real installations, several suitable tools can be used to perform this verification:

- Blackbody radiator (examples attached, most commonly used): A laboratory-grade or portable infrared reference emitter with an electronically controlled surface temperature.
- Professional thermal test panels: Electrically heated flat panels used for field verification or quality assurance in industrial fire protection.

These products allow verification both indoors and outdoors, provided environmental factors (wind, sunlight, reflections) are controlled or compensated.



Fig. 8: Calibration Precision Infrared Calibrators 4180/4181 by Fluke



Fig. 9: Calibration Radiator BR400 by Optris

Acceptance Test Scenario Using a Blackbody Radiator

A blackbody radiator represents the physical ideal of a perfect emitter (emissivity $\epsilon = 1.0$). It produces a stable, uniform temperature field without reflections and serves as the reference standard for radiometric verification. Because of its predictable behavior, the blackbody is preferred for acceptance testing and calibration validation in certified fire detection systems.

The following checklist describes best practices for verifying and accepting the two most important factors when using TFD systems - the general measurement accuracy of temperatures and the alarm behavior when the selected temperature thresholds are exceeded:

1. Set Up Test

- Place the blackbody within the camera's field of view, ideally at the same distance as the monitored objects. When monitoring very large areas, it is advisable to choose a suitable medium distance.
- Ensure that the active emission area of the blackbody is at least 3×3 pixels in the thermal image. This guarantees a sufficiently large measurement area for accurate temperature verification.
- The blackbody's surface should appear as a uniform area without edge effects or reflections.

2. Conduct Reference Measurement

- Measure the blackbody surface temperature with a **certified infrared thermometer** at the center of the emission area.
- Record this temperature as the reference value.

3. Verify Temperature Measurement Accuracy Using TFD System

- Observe the temperature reading from the corresponding measurement area in the MOBOTIX camera.
- Compare the displayed temperature to the reference thermometer reading. The deviation should typically remain within $\pm 10^{\circ}\text{C}/\pm 18^{\circ}\text{F}$ depending on the ambient conditions on site.
- Repeat the measurement at multiple temperature levels (e.g., $60^{\circ}\text{C}/140^{\circ}\text{F}$, $80^{\circ}\text{C}/176^{\circ}\text{F}$, $100^{\circ}\text{C}/212^{\circ}\text{F}$ to verify linear accuracy as it serves your application (e.g. pre-alarm and main alarm threshold temperatures).

NOTE! In cases where the radiation source used is not a blackbody, the reference measurement with a standardized thermometer can also be used to ensure the stability and uniformity of the temperature of the radiation source.

4. Check Thresholds and Verify Alarms

- Increase the blackbody temperature to exceed the configured pre-alarm and main-alarm thresholds.
- Confirm that the pre-alarm and main alarm trigger as expected within the required response times.
- The system should trigger when at least 2 pixels of the sensor covering the blackbody area exceed the configured threshold (allowing 1 pixel tolerance as a buffer for image noise or pixel variation).
- Verify alarm signals at all connected interfaces according to required pre-alarm and main alarm procedures (fire control panel, MOBOTIX HUB, MxManagementCenter, SCADA system, etc).

NOTE!

- For accurate temperature measurement verification, the radiating source must cover at least 3x3 pixels to ensure stable averaging and avoid single-pixel errors or edge effects.
- For alarm verification, 1-2 pixels are sufficient since the system triggers on the hottest pixels within the configured measurement area.

Therefore, the maximum verification distance for accurate measurement is typically shorter than the distance for alarm triggering, as larger pixel coverage requires a closer setup.

MOBOTIX provides a calculator on its website to determine the maximum distance of reference sources from the TFD system.

5. Supply Documentation

- Save screenshots or short thermal video sequences as proof of successful verification.
- Record test results in the installation/acceptance report, noting trigger points, response times, ambient conditions, used reference source and distances.

Verification Using MOBOTIX MxThermalValidation App

The MOBOTIX MxThermalValidation app is designed to distinguish real temperature events from reflections, moving heat sources or transient disturbances. It enhances the reliability of Thermal Fire Detection (TFD) in dynamic environments such as recycling plants, waste bunkers, or industrial halls with machinery movement. For a detailed introduction to the functions and general conditions of the MxThermalValidation app, please refer to the corresponding app documentation.

This checklist describes a best-practice acceptance procedure to verify that the app and the TFD system operate correctly with a suitable radiating reference source under controlled, simulated test conditions.

1. Prepare for Verification

- Ensure the TFD system and the MOBOTIX MxThermalValidation app are properly configured and active.
- Prepare a radiating reference source (e.g., blackbody radiator or equivalent) that meets the specified test conditions for accurate temperature measurement (minimum 3×3 pixels spot coverage).
- Set the reference source to remain stable and stationary during the entire test.
- Record the configured alarm threshold temperatures (e.g., 80°C/176°F).

2. Set Up Verification Procedure

- Position the reference source within the camera's field of view but cover it completely so it cannot be detected by the TFD system.
- Begin the heating process of the reference source, targeting the configured threshold temperature.

3. Partially Expose Reference Source

- As heating begins, partially uncover (≈50%) the reference source so that the TFD can partially measure its thermal radiation.

- Continue heating until the measured temperature in the TFD image reaches the configured threshold (e.g., pre-alarm threshold 80°C/176.0°F).

4. Conduct Learning Phase

- Once the threshold temperature is reached, keep the setup unchanged for 20–25 seconds to allow the MxThermalValidation app to analyze the static heat signature.
- During this period, confirm that the app displays a detected temperature spot within the defined measurement area in the TFD system's live image, indicating that the object is recognized as a relevant hot-spot.

5. Simulate Growth of Hotspot

- After the learning phase, fully uncover the reference source to simulate the natural growth of a hot-spot.
- Observe the TFD system and confirm that the system immediately triggers the configured alarm (visual and/or via output interface).

Expected Results

- The TFD system correctly detects and displays the hotspot after the learning phase.
- When the heat signature expands, the MxThermalValidation app confirms the event and the TFD system triggers the alarm as configured.
- No false alarms occur during static or partially covered phases.

CAUTION! During the entire simulation process, both the TFD system and the reference source must remain completely stationary, especially after exceeding the configured threshold temperatures. Any movement could lead to invalid test results or false interpretation by the MOBOTIX MxThermalValidation app.

Handover to Customer

Handing over the MOBOTIX Thermal Fire Detection (*TFD*) system to the customer documents the final step of the installation.

Handover to the customer serves to:

- Document the design of the TFD system.
- Document the status of the system as a point of reference for modifications.

Documentation of Handover

Print and fill out the [Project Handover Documentation, p. 72](#), then archive this document with the system documentation.

CAUTION! All records shall be archived with the system documentation for at least five years or according to local fire-safety regulations.

Maintenance

This section contains the following information:

Maintenance and Service	56
Cleaning the Camera and Lenses	56

Maintenance and Service

Regular maintenance is legally required and ensures that the MOBOTIX Thermal Fire Detection (*TFD*) system continuously provides reliable temperature measurements and early-fire detection accuracy in all environments. This service typically includes inspection, cleaning and functionally testing at defined intervals to maintain compliance and operational performance.

Maintenance serves to:

- Verify measurement accuracy and correct alignment of all thermal cameras.
- Ensure unobstructed optics and clean protective housings.
- Confirm the correct functioning of measurement areas, alarm logic and, if applied, the MOBOTIX MxThermalValidation app.
- Detect configuration drift or environmental changes that negatively affect performance.
- Keep the camera and app software up-to-date to benefit from performance and security improvements.

Documentation of Inspection and Maintenance

Print and fill out the [Project Semi-Annual Inspection & Maintenance Documentation, p. 77](#), then archive this document with the system documentation.

CAUTION! All records shall be archived with the system documentation for at least five years or according to local fire-safety regulations.

Cleaning the Camera and Lenses

Clean the camera housing using a mild alcohol-free detergent without abrasive particles.

To protect the lens protection glass, only use the supplied mounting supplies (see [Mounting Supplies: Scope of Delivery, p. 19](#)).

Cleaning the lens protection glass

- Use the wide end of the module wrench [M.1, p. 19](#) to remove/install the lens protection glass. The narrow side of the wrench is used to adjust the sharpness (focal length) of the tele lenses.

- You should clean the lens protection glasses and domes regularly using a clean, lint-free cotton cloth. If the dirt is more persistent, add a mild alcohol-free detergent without abrasive particles.
- Make sure you instruct cleaning personnel on how to clean the camera.

Technical Specifications

This section contains the following information:

Order Information	60
Hardware	60
Image and Video Properties	62
General Software Features	63
Optional MOBOTIX Apps for EN 54 Fire Detection	64
Video Management Software	65
Sensor Modules	65
Functional Modules	66
Interface Boxes	67
Connector Box RJ45	68
Dimensions	69

Order Information

Order Code:	Bundle
Mx-M73TA-B336R100-EN54	M73 EN54 Bundle-V2 CIF (45°)
Mx-M73TA-B336R150-EN54	M73 EN54 Bundle-V2 CIF (25°)
Mx-M73TA-B336R280-EN54	M73 EN54 Bundle-V2 CIF (17°)
Mx-M73TA-B640R050-EN54	M73 EN54 Bundle-V2 VGA (90°)
Mx-M73TA-B640R080-EN54	M73 EN54 Bundle-V2 VGA (69°)
Mx-M73TA-B640R100-EN54	M73 EN54 Bundle-V2 VGA (45°)
Mx-M73TA-B640R150-EN54	M73 EN54 Bundle-V2 VGA (32°)

Hardware

Feature	Properties
Image sensor (color or B&W)	Up to 4K UHD 3840x2160, 16:9, 1/1,8"
Light sensitivity	<ul style="list-style-type: none"> ■ Color sensor (day): 0,1 lx @ 1/60s; 0,005 lx @ 1s ■ BW sensor (night): 0,02 lx @ 1/60s; 0,001 lx @ 1s
Exposure control	Manual and automatic mode 1 s to 1/16,000 s
IK protection class	IK10 (housing)
IP / NEMA protection class	IP66 / NEMA 4X
Operating temperature range	-40 to 65 °C/-40 to 149 °F
Min. cold start temperature	-30 °C/-22 °F
Relative Humidity	95 % non-condensing
Internal DVR Storage	Internal microSD card (SDHC/SDXC), 8 GB out-of-the-box, max. 2 TB.
I/Os	Via Mx-F-4IOA; see Interface Boxes, p. 67
Passive infrared sensor (PIR)	Integrated in Mx-F-MSA, max. 4.5 Watt (see Functional Modules, p. 66)

Feature	Properties
Shock detector (tamper detection)	Yes
Max. power consumption	<ul style="list-style-type: none"> ▪ Max. 25 W/1042 mA at 24 VDC
Electrical surge protection	Optional with MOBOTIX MX-Overvoltage-Protection-Box-LSA (not part of the scope of delivery)
PoE standard	PoE Plus (802.3at-2009)/Class 4
Interfaces	<ul style="list-style-type: none"> ▪ Ethernet 1000BaseT ▪ miniUSB / USB2.0 High-Speed ($V_{out} = 5.1V$, $I_{out} = 0.9A$, $P_{out} = 4.5W$)
Mounting Options	Wall- or pole-mountable (with Pole Mount accessory)
Dimensions (height x width x depth)	228 x 153 x 232 mm
Weight with sensor modules	Approx. 2.7 kg/6 lb
Housing	Aluminum, PBT-30GF
Standard accessories	See Mx-M73A: Scope of Delivery, p. 17
Tiltability of camera	Horizontal: 2 x 180 degrees Vertical: 110 degrees
Detailed technical documentation	www.mobotix.com > Services > Download Center > Marketing & Documentation
MTBF	80,000 hours
Certificates	EN 50121-4, EN 55032, EN 55035, EN54-10:2002, EN54-10:2002/A1:2005, EN 61000-6-1, EN 61000-6-2, EN 61000-6-3, EN 61000-6-4, EN 62368-1, EN 63000, AS/NZS CISPR32, 47 CFR Part 15b, NRTL, EN 54-18, FM 3260
Protocols	DHCP (client and server), DNS, ICMP, IGMP v3, IPv4, IPv6, HTTP, HTTPS, FTP, FTPS, MQTT, NFS, NTP (client and server), RTP, RTCP, RTSP, SFTP, SIP (client and server), SMB/CIFS, SNMP, SMTP, SSL/TLS 1.3, TCP, UDP, VLAN, VPN, Zero-conf/mDNS
Manufacturer warranty	5 years

Power Consumption

CAUTION!

To comply with the requirements of EN 54-4, the entire fire detection system (cameras, alarm systems, etc.) must be protected by uninterruptible power supplies (UPS) or batteries that can bridge power outages of up to 72 hours!

Search for "Standby supply" in the EN 54-4 standards document.

M73 EN54 Bundle-V2

Components	Average Power Consumption	Max. Power Consumption
<ul style="list-style-type: none"> ■ Mx-M73A ■ M1: Thermal Image Sensor ■ M3: Multisense ■ Mx-F-4IOA ■ Mx-F-NPAA 	<ul style="list-style-type: none"> ■ 12.5 W/520 mA at 24 VDC 	<ul style="list-style-type: none"> ■ Max. 25 W/1042 mA at 24 VDC

M73 EN54 Bundle-V2 and D/N Image Module

Components	Average Power Consumption	Max. Power Consumption
<ul style="list-style-type: none"> ■ Mx-M73A ■ M1: Thermal Image Sensor ■ M2: Day/Night sensor module ■ M3: Multisense ■ Mx-F-4IOA ■ Mx-F-NPAA 	<ul style="list-style-type: none"> ■ 13.5 W/562 mA at 24 VDC 	<ul style="list-style-type: none"> ■ Max. 25 W/1042 mA at 24 VDC

Image and Video Properties

Feature	Properties
Available video codecs	<ul style="list-style-type: none"> ■ H.264, H.265 ■ MxPEG+ ■ MJPEG
Image resolutions	CIF 320x240, VGA 640x360, XGA 1024x576, HD 1280x720, FullHD 1920x1080, QHD

Feature	Properties
	2560x1440, 4K UHD 3840x2160
Multi streaming	H.264, H.265 with triple streaming
Multicast stream via RTSP	Yes
Max. image resolution H.264	<ul style="list-style-type: none"> ■ One thermal sensor: VGA 640x480/CIF 320x240 ■ One thermal sensor, one optical sensor: 1xVGA 640x480/CIF 320x240, 1x 4K UHD 3840x2160 (8MP)
Max. frame rate	MxPEG: 20@4K, H.264: 30@4K, H.265: 30@4K

General Software Features

Feature	Properties
Software features	<ul style="list-style-type: none"> ■ H.264, H.265 Multistreaming ■ Multicast stream via RTSP ■ Digital pan, tilt, zoom/vPTZ (up to 8x zoom) ■ Genetec protocol integration ■ Programmable exposure zones ■ Snapshot recording (pre/post-alarm images) ■ Continuous recording ■ Event recording ■ Time-controlled flexible event logic ■ Weekly schedules for recordings and actions ■ Event video and image transfer via FTP and email ■ Playback and QuadView via web browser ■ Animated logos on the image ■ Master/Slave functionality ■ Privacy zone scheduling ■ Remote alarm notification (network message) ■ Programming interface (HTTP API) ■ MxMessageSystem
ONVIF compatibility	Profile G, S, T
Master/Slave functionality	Yes
Remote alarm notification	Email, network message (HTTP/HTTPS), SNMP, MxMessageSystem,

Technical Specifications

Optional MOBOTIX Apps for EN 54 Fire Detection

Feature	Properties
	MQTT ModBus TCP* *In combination with MxThermalValidation or MxAdvancedRadiometry apps (optional, requires additional license)
DVR/image storage management	<ul style="list-style-type: none">▪ On internal microSD card▪ On external USB and NAS devices▪ Different streams for live image and recording▪ MxPEG+ only▪ MxFFS with buffered archive, pre- and post-alarm images, storage monitoring with error reporting
Camera and data security	User and group management, SSL connections, IP-based access control, IEEE 802.1X, intrusion detection, digital image signature
Digitally signed firmware	Yes (to prevent firmware file tampering)

Optional MOBOTIX Apps for EN 54 Fire Detection

- MxAdvancedRadiometry (see [Technical Specifications](#)).
- MxThermalValidation (see [Technical Specifications](#)).

NOTE!

- Use of these optional apps is based on the specified use cases and subject to acceptance testing by the independent auditor.
- These MOBOTIX apps require additional licensing (30 days free trial included).

Video Management Software

Feature	Properties
MOBOTIX HUB	Yes Services > Download Center > Software Downloads">www.mobotix.com > Services > Download Center > Software Downloads
MxManagementCenter	Yes (latest version recommended) Services > Download Center > Software Downloads">www.mobotix.com > Services > Download Center > Software Downloads
MOBOTIX LIVE App	Yes (available in Google Play Store (Android) and Apple App Store (iOS)).
3rd Party VMS Software	See ONVIF Profile S, T and G specification

Sensor Modules

Features Thermal Image Sensors – B Models

Feature	Properties
Thermal sensitivity	Typ. 50 mK
Thermal image sensor	Uncooled microbolometer, CIF: 336 x 256 px / VGA: 640 x 480 px
IR range	7.5 to 13.5 μm
Temperature measurement range (adjustable)	High Sensitivity: -40 to 170°C/-40 to 320°F Low Sensivity: -40 to 550°C/-40 to 1022°F Default: Automatic (switches between High and Low depending on highest temperatures in FoV)
Max. image size	Can be scaled up to 3072 x 2048 (6MP), automatically scaled to size of MX sensor module
Max. frame rate	9 fps (fast version 25/30 fps on request)
Pixel pitch	17 μm

Technical Specifications

Functional Modules

Feature	Properties
Field of view	<i>Sensor Module</i> <i>FoV</i>
	336R/T100 45° x 35°; 2.27 mrad; focal length 7.5 mm, f/1.25
	336R/T150 25° x 19°; 1.31 mrad; focal length 13 mm, f/1.25
	336R/T280 17° x 13°; 0.90 mrad, focal length 19 mm, f/1.25
	640R/T050 90° x 69°; 2.27 mrad; focal length 7.5 mm, f/1.4
	640R/T080 69° x 56°; 1.89 mrad; focal length 9 mm, f/1.4
	640R/T100 45° x 37°; 1.31 mrad; focal length 13 mm, f/1.25
	640R/T150 32° x 26°; 0.90 mrad; focal length 19 mm, f/1.25
Operating temperature range	-40 to 65 °C/-40 to 149 °F
Relative Humidity	95 % non-condensing
MTBF	80,000 hours
IP rating	IP67
IK rating	IK04
Material	PBT-30GF (housing)

Functional Modules

Functional Module	Order Code	Remark
Audio module (optional)	Mx-F-AUDA	Audio module with microphone and speaker
MultiSense module (included)	Mx-F-MSA	With PIR sensor, temperature sensor, illumination sensor

Interface Boxes

Mx-F-4IOA

Inputs	4 galvanically separated inputs, self powered, up to 30 Vrms AC / 50V DC Switching thresholds: <ul style="list-style-type: none"> ▪ Input >1.6V leads to a detected HIGH ▪ Input <0.9V leads to a detected LOW (after a high) max. length for cables: 50m	
Outputs	4 Form A relay contacts (max 30 Vrms AC / max, 50V DC/ 60 W/ 2A DC)	
Wire specifications (terminals)	<i>Conductor cross section</i>	
	AWG	20 - 26
	Rigid	0.14mm ² - 0.8mm ²
	Flexible	0.14mm ² - 0.5mm ²
	Flexible with ferrule	0.25mm ² - 0.34mm ²
Status indicators	Multi-color LEDs (Green, Red); refer to Mx-F-4IOA Quick Installation	
Mounting	Mx-M-OW-M73 (wall mount) Mx-M-CM-M73 (ceiling mount)	

Mx-F-NPAA

Input voltage	12 to 24 V (tolerance range 10.71 to 26.4 V)
Output voltage	PoE Class 1 to 4 (up to 25 W)

General Hardware Specifications

Power consumption	Typ. 1 W/200 mA
Protection class	IP66
Operating temperature	-30 to 60 °C/-22 to 140 °F
Certificates	CE, EMC, ROHS,

Technical Specifications

Connector Box RJ45

AS/NZS CISPR 32,
47 CFR FCC Part 15, Subpart B, Class A,
ICES-003 Class A,
EN 54-18

Dimensions (width x height x depth)	86 x 56 x 31 mm/3.39 x 2.20 x 1.22 in (without rubber plugs)
--	---

Weight	70 g
--------	------

Connector Box RJ45

Interface

Properties

Network	100/1000 Mbps
---------	---------------

Allowed cable dimensions for cables connected to the PCB terminals

Conductor cross section

AWG	20 - 26
-----	---------

Rigid	0.14mm ² - 0.8mm ²
-------	--

Flexible	0.14mm ² - 0.5mm ²
----------	--

Flexible with ferrule	0.25mm ² - 0.34mm ²
-----------------------	---

Line In	Standard Line In: (0dB) Vrms=1V
---------	---------------------------------

Line Out	Headphones with 20mW @ 16 Ohm or 32 Ohm.
----------	--

Audio inputs as a Line Out function to 10k Ohm impedance of receiver. Audio level while connected to 10k Ohm equals -10dbV

Dimensions

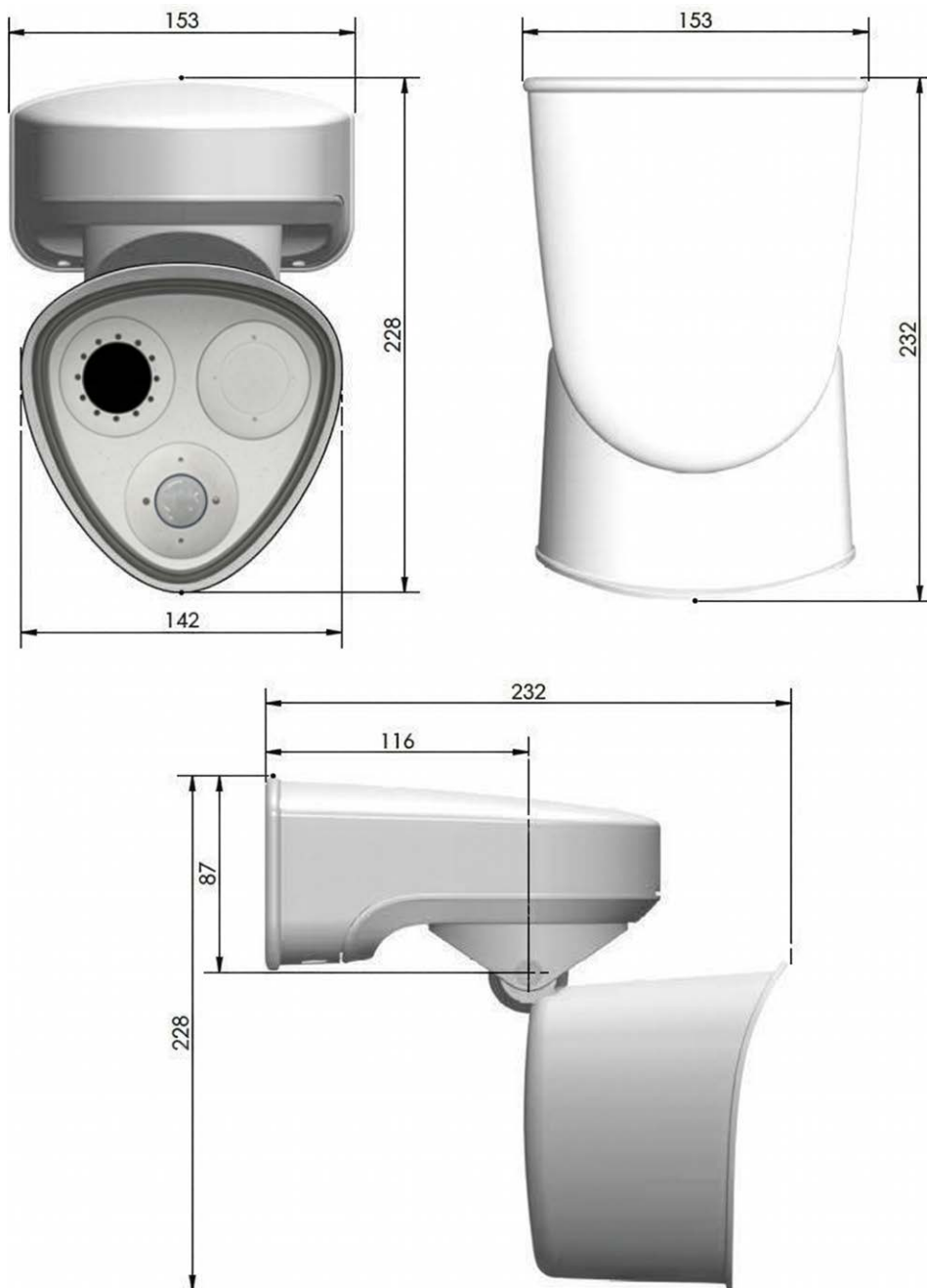

Fig. 10: MOBOTIX M73: All measurements in mm

NOTE! Drilling template: www.mobotix.com > Services > Download Center > Marketing & Documentation > Drilling Templates.

Dimensions of Interface Boxes

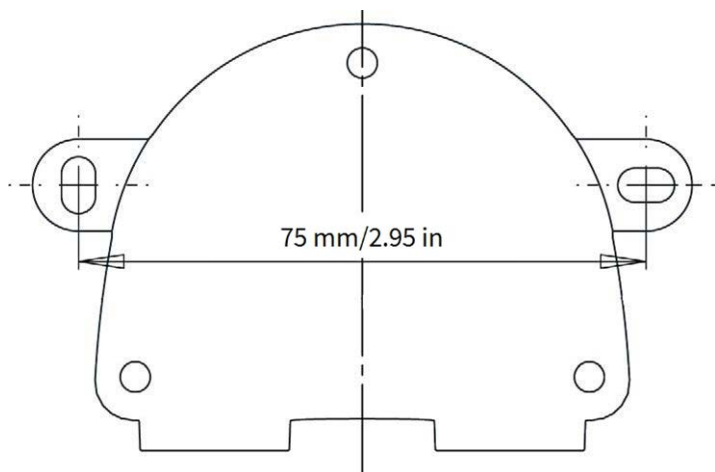

Fig. 11: All measurements in mm

NOTE!

When printing this page at 100% of the original size (no scaling) you can use this page as drilling template.

Appendix

This section contains the following information:

Appendix A: Project Handover Documentation	72
Appendix B: Project Semi-Annual Inspection & Maintenance Documentation	77
Appendix C: Planning Guide	83
Appendix D: Manually Calibrating a Thermal Radiometry Sensor	86

Appendix A: Project Handover Documentation

This checklist supports customer handover documentation for an EN 54-compliant Thermal Fire Detection (TFD) camera.

1. General Project Information

Check	Item	Remarks
<input type="checkbox"/>	Project name / reference number	_____
<input type="checkbox"/>	Installation address	_____
<input type="checkbox"/>	Customer contact(s)	_____
<input type="checkbox"/>	Installer/integrator details	_____
<input type="checkbox"/>	Date of commissioning	_____
<input type="checkbox"/>	Responsible commissioning engineer	_____

2. Product Identification & EN 54 Compliance

Check	Item	Remarks
<input type="checkbox"/>	Device type (flame detector/camera) and model	_____
<input type="checkbox"/>	Serial number(s)	_____
<input type="checkbox"/>	Firmware/software version	_____
<input type="checkbox"/>	Hardware revision	_____
<input type="checkbox"/>	EN 54 certificate / approval reference	_____

Check	Item	Remarks
<input type="checkbox"/>	Declaration of Performance (DoP) (if applicable)	_____
<input type="checkbox"/>	CE marking documentation	_____
<input type="checkbox"/>	Technical specifications of product incl. detection class / sensitivity (as applicable)	_____

3. Site Risk & Application Suitability

Check	Item	Remarks
<input type="checkbox"/>	Protected area and fire scenario (fuel type, expected flame size)	_____
<input type="checkbox"/>	Known nuisance sources (sunlight, welding, hot work, reflections)	_____
<input type="checkbox"/>	Line-of-sight confirmed (no permanent obstructions)	_____
<input type="checkbox"/>	Environmental conditions (temperature, humidity, dust/smoke, vibration)	_____
<input type="checkbox"/>	Detector placement justification (coverage concept)	_____

4. Installation Documentation

Check	Item	Remarks
<input type="checkbox"/>	Installation layout drawings	_____
<input type="checkbox"/>	Detector location(s) marked on drawings	_____
<input type="checkbox"/>	Field of view / coverage documentation (angles, distances)	_____
<input type="checkbox"/>	Mounting height and orientation	_____

Check	Item	Remarks
<input type="checkbox"/>	Cable routing and termination points	_____
<input type="checkbox"/>	Power supply type and rating	_____
<input type="checkbox"/>	Network topology (if IP-based)	_____

5. System Integration & Alarm Paths

Check	Item	Remarks
<input type="checkbox"/>	Interface to Fire Alarm Control Panel (FACP)	_____
<input type="checkbox"/>	Alarm transmission	_____
<input type="checkbox"/>	Malfunction transmission	_____
<input type="checkbox"/>	Restore/reset behavior	_____
<input type="checkbox"/>	Cause-and-effect / fire safety matrix	_____
<input type="checkbox"/>	Alarm annunciation locations (panel, SCADA, VMS, etc.)	_____

6. Commissioning Tests (EN 54-Compliant)

Check	Item	Remarks
<input type="checkbox"/>	Power-up and self-test completed successfully	_____
<input type="checkbox"/>	End-to-end alarm test (detector → FACP → outputs)	_____
<input type="checkbox"/>	End-to-end fault test (e.g., disconnect/simulated trouble)	_____
<input type="checkbox"/>	Functional flame response test using approved test method	_____

Check	Item	Remarks
<input type="checkbox"/>	Response time within project requirements	_____
<input type="checkbox"/>	Nuisance immunity checks (sun-/reflections/hot work scenarios as relevant)	_____
<input type="checkbox"/>	Evidence added (test protocol, photos/log exports)	_____

7. Configuration & Cyber/Access Controls

Check	Item	Remarks
<input type="checkbox"/>	Network settings (IP, VLAN, ports)	_____
<input type="checkbox"/>	User roles and access rights	_____
<input type="checkbox"/>	Relevant user names and passwords	_____
<input type="checkbox"/>	Time synchronization (NTP)	_____
<input type="checkbox"/>	Enable event logging	_____
<input type="checkbox"/>	Backup of configuration	_____

8. Customer Package

Check	Item	Remarks
<input type="checkbox"/>	User manual	_____
<input type="checkbox"/>	Installation manual	_____
<input type="checkbox"/>	Maintenance instructions	_____
<input type="checkbox"/>	Spare parts / accessories list (if applicable)	_____

Appendix

Appendix A: Project Handover Documentation

Check	Item	Remarks
<input type="checkbox"/>	Warranty and service contact details	_____
<input type="checkbox"/>	Training performed (operator and maintenance staff)	_____

9. Acceptance

Item	Entry
Owner/Customer (Name)	_____
Customer Representative (Name)	_____
Date	_____
Signature	_____

Appendix B: Project Semi-Annual Inspection & Maintenance Documentation

This checklist supports semi-annual inspection and preventive maintenance for an EN 54-compliant Thermal Fire Detection (TFD) camera by qualified service personnel.

1. Service Visit Details

Check	Item	Remarks
<input type="checkbox"/>	Customer/site identified	_____
<input type="checkbox"/>	Device model and serial number	_____
<input type="checkbox"/>	Firmware/software version	_____
<input type="checkbox"/>	Date/time of service	_____
<input type="checkbox"/>	Technician name	_____

2. Visual Inspection (Detector & Mounting)

Check	Item	Remarks
<input type="checkbox"/>	Housing intact (no cracks, deformation, tamper evidence)	_____
<input type="checkbox"/>	Mounting secure (bracket, screws, safety tether if applicable)	_____
<input type="checkbox"/>	Cable glands/seals intact (no water ingress)	_____
<input type="checkbox"/>	No corrosion observed	_____

Check	Item	Remarks
<input type="checkbox"/>	Lens/window clean and undamaged	_____
<input type="checkbox"/>	Field of view unobstructed (no new equipment, signage, storage)	_____

3. Environmental / Nuisance Source Review

Check	Item	Remarks
<input type="checkbox"/>	No new reflective surfaces causing potential false alarms	_____
<input type="checkbox"/>	No new sources of strong IR/UV in view (welding, heaters, sunlight reflections)	_____
<input type="checkbox"/>	Hot work procedures in place (if relevant)	_____
<input type="checkbox"/>	Ambient conditions within specification	_____

4. Electrical & Network Checks

Check	Item	Remarks
<input type="checkbox"/>	Supply voltage within specification	_____
<input type="checkbox"/>	Power redundancy verified (if applicable)	_____
<input type="checkbox"/>	Network link stable (if IP-based)	_____
<input type="checkbox"/>	Time synchronization (NTP) verified	_____
<input type="checkbox"/>	Grounding/shielding checked (if applicable)	_____

5. Functional Checks

Check	Item	Remarks
<input type="checkbox"/>	Live video / sensor signal verified (if applicable)	_____
<input type="checkbox"/>	Self-test status OK (no active internal faults)	_____
<input type="checkbox"/>	Alarm test executed using approved test method for flame detection	_____
<input type="checkbox"/>	Alarm received at FACP (and any connected systems)	_____
<input type="checkbox"/>	Alarm reset/restore verified	_____
<input type="checkbox"/>	Fault/trouble test executed (e.g., disconnect, simulated failure)	_____
<input type="checkbox"/>	Fault received at FACP	_____

6. Integrity of Logs, Events & Configuration

Check	Item	Remarks
<input type="checkbox"/>	Event logs for alarms/troubles since last service	_____
<input type="checkbox"/>	Any repeated nuisance alarms investigated and acknowledged	_____
<input type="checkbox"/>	Configuration verified against baseline (no unauthorized changes)	_____
<input type="checkbox"/>	Configuration backup exported (if allowed by process)	_____

7. Cleaning & Preventive Maintenance

Check	Item	Remarks
<input type="checkbox"/>	Lens/window cleaned using manufacturer-approved method	_____
<input type="checkbox"/>	Housing cleaned	_____
<input type="checkbox"/>	Mounting hardware retightened (as needed)	_____
<input type="checkbox"/>	Seals checked/replaced (as needed)	_____

8. Findings & Corrective Actions

#	Finding / Defect	Action Taken	Status (Open/Closed)
1			_____
2			_____
3			_____
4			_____
5			_____

6

7

8

9

10

9. Service Confirmation

Item

Entry

Service Technician (Name)

Date

Signature

10. Acceptance

Item	Entry
Owner/Customer (Name)	
Customer Representative (Name)	
Date	
Signature	

Appendix C: Planning Guide

The following guidance is based on the 640R050 sensor module (90x69° field of view) camera.

General Purpose

- Define purpose and coverage zones.
- Identify critical assets and fire risks.

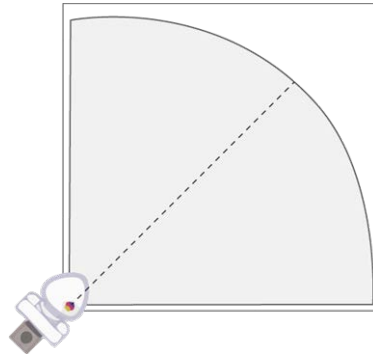

Perform Site Survey and Risk Assessment

- Assess ambient variations.
- Check for reflective surfaces (sun glare, windows, etc.).
- Check for moving objects (vehicle headlights, opened or closed windows, overhead cranes, etc).

Determine Mounting Height

As a rule of thumb, install the camera at approximately twice the height of the tallest object in the field of view:

$$h_d = 2 \times h_o$$

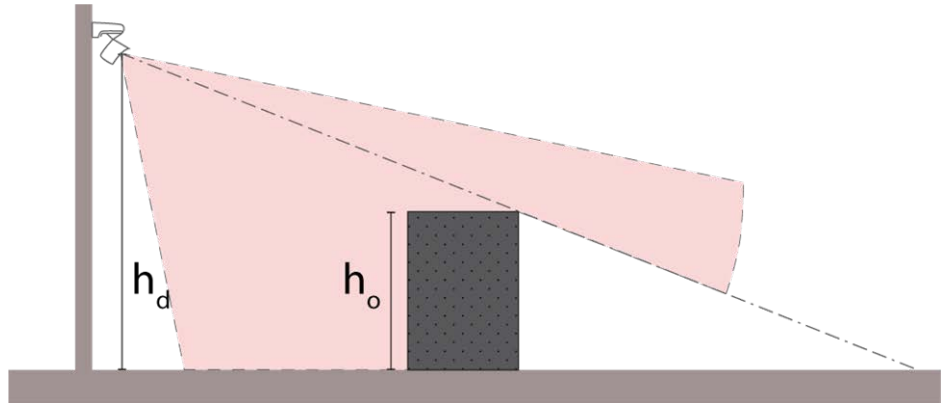

Determine Field of View (FOV)

- Select the thermal sensor FOV to cover all critical areas.
- Eliminate blind spots by adding cameras as needed.

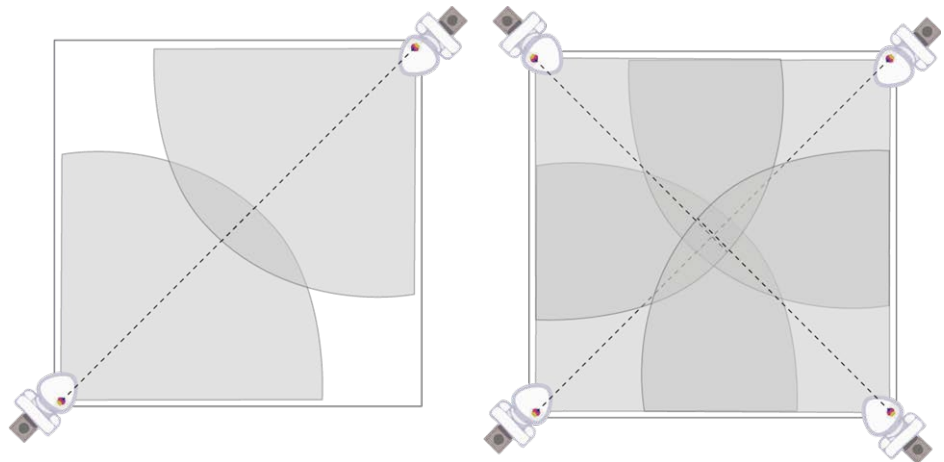

Avoid Obstructions

Prevent pipes, walls or equipment from blocking potential flame or heat sources.

Calibration and Testing

After installation, calibrate and test to verify reliable alarm behavior at the certified distance (25 m/27.34 yd for EN 54).

Pixels per Meter (ppm) at Distance

Sensor Type CIF (Gen 7)	FOV	ppm @25 m/27.34 yd	ppm @50 m/54.68 yd	ppm @75 m/82.02 yd
336R100	45×35°	17	9	6
336R280	17×13°	45	23	15
336R500	9×7°	85	43	29

Sensor Type VGA (Gen 7)	FOV	ppm @25 m/27.34 yd	ppm @50 m 54.68 yd	ppm @75 m/82.02 yd
640R050	90×69°	16	8	5
640R100	45×37°	33	16	11

Appendix D: Manually Calibrating a Thermal Radiometry Sensor

This step improves the preciseness of thermal sensor measurements when using the **MOBOTIX MxThermalHeatDetection** app together with a **Thermal Radiometry** sensor.

Calibrating the thermal sensor is not mandatory, but can help avoid false alarms and incorrect measurements in difficult situations. These may include unwanted airflow when moving air is falsifying measurements and also depend on the emissivity of the object you want to measure.

Avoid Thermal Interference Around the Object

Make sure to avoid unwanted thermal influences close to the object you want to measure. Be aware that objects (especially metals and glass) can reflect radiation from other heat sources and distort the measurement.

NOTE!

Before actually installing the camera, you can use the camera with thermal sensor to scan the surrounding area of the camera for sources of unwanted airflow, such as:

- Heating or cooling systems
- Hot or cold objects between the thermal sensor and the object
- Hot or cold vapor of any kind

Determine the Emissivity of the Object's Surface

"The emissivity of the surface of a material is its effectiveness in emitting energy as thermal radiation."

[Source: en.wikipedia.org/wiki/Emissivity]

Emissivity is influenced by these factors:

- Surface material, its degree of smoothness and the form (flat, concave, convex).
- Atmospheric temperature
- Transmissivity of the air between the sensor and the object
- Angle of measurement

Thermal sensors can accurately measure the temperature of objects with an emissivity of greater than or equal to 50%. A possible solution for objects with an emissivity lower than 50% is to put a sticker (adhesive tape) with a high and known emissivity on the material to be measured. You can then measure this spot to get an accurate measurement.

NOTE!

- See the [Thermal Emissivity Table](#) on the MOBOTIX website for a list of emissivity values. If you are looking for other materials, search for "emissivity values" on the web.
- When in doubt, use 0.90 as a safe default emissivity value for mixed waste or most non-metallic, matte or coated surfaces.



Determine the Atmospheric Temperature

The atmospheric temperature is the temperature of the atmosphere between the thermal sensor and the target. In an ideal setting, this temperature remains the same throughout the day.

Since temperatures can vary for various reasons (ambient temperature, sunlight, heat sources, etc.), it makes sense to use the *average temperature* (and consider that this may affect measurement accuracy).

Determine the Transmissivity of the Atmosphere

The transmissivity of the atmosphere between the sensor and the object is a measure of how well electromagnetic waves can travel through this space. Two factors are important:

- The distance between the sensor and the object.
- The structure of the atmosphere between the sensor and the object.

While the distance is fixed in most applications, transmissivity of the atmosphere between the sensor and the object is more difficult to measure. The following procedure can help set the proper transmissivity:

- Put a black body or any other reference object with a known temperature next to the object.
- Adjust the **Humidity** parameter until the detection area shows the same temperature reading as the reference object.

Test the Measurements Under Extreme Conditions

You should periodically test the measurements under different conditions and adjust the parameters, if required:

- On hot and cold days.
- During the day and at night.
- Open and closed doors, especially when doors open to the outside and there is a large difference between the inside and outside temperature.

MOBOTIX

BeyondHumanVision

[EN_05/26](#)

MOBOTIX AG • Kaiserstrasse • D-67722 Langmeil • Tel.: +49 6302 9816-103 • sales@mobotix.com • www.mobotix.com

MOBOTIX is a trademark of MOBOTIX AG registered in the European Union, the U.S.A., and in other countries. Subject to change without notice. MOBOTIX do not assume any liability for technical or editorial errors or omissions contained herein. All rights reserved. © MOBOTIX AG 2025